

Analysis of the Coordination of Suppression and Ventilation in Single-Family Homes

John Regan
Julie Bryant
Craig Weinschenk

UL Firefighter Safety Research Institute
Columbia, MD 20145

UNDERWRITERS
LABORATORIES™



Analysis of the Coordination of Suppression and Ventilation in Single-Family Homes

John Regan
Julie Bryant
Craig Weinschenk

UL Firefighter Safety Research Institute
Columbia, MD

March 19, 2020

UNDERWRITERS
LABORATORIES™



Underwriters Laboratories Inc.
Terrence Brady, President

UL Firefighter Safety Research Institute
Stephen Kerber, Director

In no event shall UL be responsible to anyone for whatever use or non-use is made of the information contained in this Report and in no event shall UL, its employees, or its agents incur any obligation or liability for damages including, but not limited to, consequential damage arising out of or in connection with the use or inability to use the information contained in this Report. Information conveyed by this Report applies only to the specimens actually involved in these tests. UL has not established a factory Follow-Up Service Program to determine the conformance of subsequently produced material, nor has any provision been made to apply any registered mark of UL to such material. The issuance of this Report in no way implies Listing, Classification or Recognition by UL and does not authorize the use of UL Listing, Classification or Recognition Marks or other reference to UL on or in connection with the product or system.

Acknowledgments

This project was funded through a grant from the Department of Homeland Security (DHS) Federal Emergency Management Agency's (FEMA) Assistance to Firefighters Grant (AFG) Program under the Fire Prevention and Safety Grants: Research and Development (EMW-2015-FP-00361). This critical fire service research project would not be possible without this funding and continued support.



A research project of this magnitude is only accomplished through the extraordinary efforts of the many project partners and team members. First and foremost, the authors thank the men and women of the City of Sidney Fire Department and the Beavercreek Township Fire Department. Their tireless effort, professionalism, and hospitality were integral in the conduction of these acquired structure burns. From initial contact regarding the availability of residential structures to the final breakdown of all instrumentation, both departments were excellent partners in conducting full-scale fire research for the fire service. Similarly, the authors also wish to thank the Shelby County Land Bank and Mary and Bob Nutter for the generous donation of the structures used in these experiments.

The authors wish to thank the members of the project's fire service technical panel, listed in the accompanying table, for providing support during the development and planning phase of this project and for contributing valuable feedback regarding the project results and conclusions.

Coordinated Fire Attack Technical Panel

Name	Department
Christopher Byrne	Colorado Springs Fire Department
Tony Carroll	District of Columbia Fire and EMS Department
Chad Christensen	Los Angeles County Fire Department
Shea Chwialkowski	Richfield Fire Department
Danny Doyle	Pittsburgh Fire Department
Brad French	Dayton Fire Department
Russell Gardner	Sacramento Metropolitan Fire Department
Scott Gray	Seattle Fire Department
David Guercio	Baltimore City Fire Department
Greg Hubbard	Orange County Fire Rescue
Curt Isakson	Escambia County Fire Rescue
Cody Johnson	Homer Volunteer Fire Department
Frank Leeb	Fire Department of New York
Dennis LeGear	Oakland Fire Department
Stephan Lopez	Dallas Fire-Rescue
Ray McCormack	Fire Department of New York
James Mendoza	San Jose Fire Department
Nicholas Papa	City of New Britain Fire Department
Joe Pronesti	Elyria Fire Department
Richard Riley	Kentland Volunteer Fire Department
Andrew Ruiz	Los Angeles Fire Department
Terrence Sheppard	Chicago Fire Department
Eric Staggs	City of Spokane Fire Department
Chris Stewart	Phoenix Fire Department

The authors also thank the team from the Illinois Fire Service Institute, including Gavin Horn, Richard Kesler, Jake Stewart, Hannah Newman, Shruti Ghanekar, Rajavasanth Rajasegar, and Kate Donlin, for their assistance throughout the experimental series. Particularly, their expertise in laser diagnostics and skin burn assessments improved the measurement capability of the experiments.

Finally, the commitment and dedication of the UL FSRI team—Michael Alt, Nicholas Brondum, Joshua Crandall, Philip Gilman, Sarah Huffman, Stephen Kerber, Patrick McAuliffe, Bradley Morrissey, Keith Stakes, Jennifer Williams, and Robin Zevotek—from preparation through execution and analysis was tremendous. Specifically, the authors would like to call special attention to Sarah, Keith, and Robin who led the way for our logistical support, fire fighting, and experiment command respectively. Additionally, the authors would like to extend a special thanks to Roy McLane of Thermal Fabrication for his tireless support in both the planning and execution of the experiments.

Contents

Contents	iv
List of Figures	vii
List of Tables	xv
List of Abbreviations	xvii
Abstract	1
1 Introduction	2
1.1 Objectives	3
2 Experimental Setup	4
2.1 Second Floor Bedroom Fires	4
2.1.1 Method 1 - Interior Suppression with Ventilation Post Fire Control	5
2.1.2 Method 2 - Interior Suppression with Ventilation Prior to Fire Control	6
2.1.3 Method 3 - Exterior Fire Control with Ventilation Post Initial Water Flow	7
2.1.4 Method 4 - Exterior Fire Control Effectiveness	8
2.2 First Floor Kitchen Fires	9
2.2.1 Method 5 - Interior Suppression with Ventilation Prior to Fire Control	9
2.2.2 Method 6 - Exterior Fire Control with Ventilation Post Initial Water Flow	10
2.3 Instrumentation	10
2.4 Fuel Packages	12
2.4.1 Bedroom Fuel Package	12
2.4.2 Kitchen Fuel Package	13
3 Results	16
3.1 Experiment 1 — Interior Suppression without Additional Ventilation	19
3.2 Experiment 2 — Interior Suppression with Hydraulic Ventilation	32
3.3 Experiment 3 — Interior Suppression Followed By Vertical Ventilation	45
3.4 Experiment 4 — Interior Suppression with Additional Horizontal Ventilation	57
3.5 Experiment 5 — Interior Suppression with Positive Pressure Ventilation	69
3.6 Experiment 6 — Interior Suppression with Door Control	83
3.7 Experiment 7 — Interior Suppression Following Vertical Ventilation	97
3.8 Experiment 8 — Interior Suppression Following Vertical Ventilation	110

3.9	Experiment 9 — Interior Suppression with Simultaneous Positive Pressure Ventilation	124
3.10	Experiment 10 — Exterior Fire Control with No Additional Ventilation	137
3.11	Experiment 11 — Exterior Fire Control with Positive Pressure Ventilation	148
3.12	Experiment 12 — Exterior Fire Control with Additional Horizontal Ventilation	162
3.13	Experiment 13 — Exterior Fire Control with Failed Ceiling	175
3.14	Experiment 14 — Exterior Fire Control with Failed Ceiling	188
3.15	Experiment 15 — Interior Suppression without Additional Ventilation	201
3.16	Experiment 16 — Interior Suppression with Additional Horizontal Ventilation	214
3.17	Experiment 17 — Interior Suppression with Coordinated Positive Pressure Ventilation	228
3.18	Experiment 18 — Exterior Fire Control without Additional Ventilation	244
3.19	Experiment 19 — Exterior Fire Control with Additional Horizontal Ventilation	258
3.20	Experiment 20 — Exterior Fire Control with Positive Pressure Ventilation	270
4	Discussion	287
4.1	Exposure Analysis	287
4.1.1	Occupant Gas Exposure	287
4.1.2	Occupant Thermal Exposure	289
4.1.3	Firefighter Thermal Exposure	290
4.2	Method 1, Second Floor Bedroom Fire - Ventilation Post Interior Suppression	293
4.2.1	Suppression and Ventilation Tactics	296
4.2.2	Occupant Tenability Estimate	300
4.2.3	Firefighter Helmet Thermal Exposure	304
4.3	Method 2, Second Floor Bedroom Fire – Ventilation During Interior Suppression	306
4.3.1	Suppression and Ventilation Tactics	307
4.3.2	Occupant Tenability Estimate	312
4.3.3	Firefighter Helmet Thermal Exposure	315
4.4	Method 3, Second Floor Bedroom Fire - Ventilation Post Initial Exterior Suppression	318
4.4.1	Suppression and Ventilation Tactics	319
4.4.2	Occupant Tenability Estimate	321
4.4.3	Firefighter Helmet Thermal Exposure	324
4.5	Method 4 Effect of a Failed Ceiling on Initial Exterior Suppression of a Second Floor Bedroom Fire	327
4.5.1	Suppression and Ventilation Tactics	329
4.5.2	Occupant Tenability Estimate	333
4.5.3	Firefighter Helmet Thermal Exposure	336
4.6	Method 5, First Floor Kitchen Fire - Interior Suppression Post Ventilation	338
4.6.1	Suppression and Ventilation Tactics	340
4.6.2	Occupant Tenability Estimate	343
4.6.3	Firefighter Helmet Thermal Exposure	345
4.7	Method 6, First Floor Kitchen Fire - Ventilation Post Initial Exterior Suppression	347
4.7.1	Suppression and Ventilation Tactics	349
4.7.2	Occupant Tenability Estimate	351
4.7.3	Firefighter Helmet Thermal Exposure	355

4.8	Summary	357
4.8.1	Coordination of Suppression and Ventilation Tactics	357
4.8.2	Occupant Tenability Estimate	357
4.8.3	Firefighter Helmet Thermal Exposure	362
5	Tactical Considerations	365
5.1	Evaluation of Previous Research Findings in Acquired Structures	365
5.1.1	Water Usage in Residential Fires	365
5.1.2	Speed of Transition and Regrowth	367
5.1.3	Effectiveness of Remote Water Application	370
5.1.4	Placement of Vertical Ventilation Hole	374
5.1.5	Survivable Space on Arrival	375
5.2	Timeline of Coordination	379
5.3	Maximize the Effectiveness of Water Application by Considering Alternative Means of Water Distribution	383
5.4	Local Ventilation and Remote Occupants	389
6	Future Research	394
7	Summary	395
	Definitions	395
	References	398
A	Water Flow Uncertainty	401
B	Architectural Drawings	402

List of Figures

2.1	Bedroom Fuels Representative Photographs	13
2.2	Kitchen Fuels Representative Photographs	14
3.1	Example Water Flow Data	18
3.2	Experiment 1 — Exterior Photographs	19
3.3	Experiment 1 — Instrument Plan	20
3.4	Experiment 1 — Fire Room Photographs	21
3.5	Experiment 1 — Fire Room Layout	22
3.6	Experiment 1 — Actions/Events	23
3.7	Experiment 1 — Fire Room Temperatures	24
3.8	Experiment 1 — Still Images of Wind Impact	25
3.9	Experiment 1 — Remote Temperatures	26
3.10	Experiment 1 — Heat Flux	27
3.11	Experiment 1 — Fire Room Pressures	28
3.12	Experiment 1 — Remote Pressures	29
3.13	Experiment 1 — Gas Flows Within Structure	30
3.14	Experiment 1 — Gas Concentrations	31
3.15	Experiment 2 — Exterior Photographs	32
3.16	Experiment 2 — Instrument Plan	33
3.17	Experiment 2 — Fire Room Photographs	34
3.18	Experiment 2 — Fire Room Layout	35
3.19	Experiment 2 — Actions/Events	36
3.20	Experiment 2 — Fire Room Temperatures	37
3.21	Experiment 2 — Remote Temperatures	38
3.22	Experiment 2 — Heat Flux	39
3.23	Experiment 2 — Remote Pressures	40
3.24	Experiment 2 — Gas Flows Within Structure	42
3.25	Experiment 2 — Gas Concentrations	43
3.26	Experiment 3 — Exterior Photographs	45
3.27	Experiment 3 — Instrument Plan	46
3.28	Experiment 3 — Fire Room Photographs	47
3.29	Experiment 3 — Fire Room Layout	47
3.30	Experiment 3 — Vertical Ventilation Interior Opening	48
3.31	Experiment 3 — Actions/Events	49
3.32	Experiment 3 — Fire Room Temperatures	50
3.33	Experiment 3 — Remote Temperatures	51

3.34	Experiment 3 — Heat Flux	52
3.35	Experiment 3 — Fire Room Pressures	53
3.36	Experiment 3 — Remote Pressures	54
3.37	Experiment 3 — Gas Flows Within Structure	55
3.38	Experiment 3 — Gas Concentrations	56
3.39	Experiment 4 — Exterior Photographs	57
3.40	Experiment 4 — Instrument Plan	58
3.41	Experiment 4 — Fire Room Photographs	59
3.42	Experiment 4 — Fire Room Layout	60
3.43	Experiment 4 — Actions/Events	61
3.44	Experiment 4 — Fire Room Temperatures	62
3.45	Experiment 4 — Remote Temperatures	63
3.46	Experiment 4 — Heat Flux	64
3.47	Experiment 4 — Remote Pressure	65
3.48	Experiment 4 — Gas Flows Within Structure	67
3.49	Experiment 4 — Gas Concentrations	68
3.50	Experiment 5 — Exterior Photographs	69
3.51	Experiment 5 — Instrument Plan	71
3.52	Experiment 5 — Fire Room Photographs	72
3.53	Experiment 5 — Fire Room Layout	72
3.54	Experiment 5 — Actions/Events	74
3.55	Experiment 5 — Fire Room Temperatures	75
3.56	Experiment 5 — Remote Temperatures	76
3.57	Experiment 5 — Heat Flux	77
3.58	Experiment 5 — Remote Pressures	78
3.59	Experiment 5 — Gas Flows Within Structure	80
3.60	Experiment 5 — Gas Concentration	81
3.61	Experiment 6 — Exterior Photographs	83
3.62	Experiment 6 — Instrument Plan	84
3.63	Experiment 6 — Fire Room Photographs	85
3.64	Experiment 6 — Fire Room Layout	86
3.65	Experiment 6 — Actions/Events	87
3.66	Experiment 6 — Fire Room Temperatures	88
3.67	Experiment 6 — Remote Temperatures	89
3.68	Experiment 6 — Heat Flux	91
3.69	Experiment 6 — Remote Pressure	93
3.70	Experiment 6 — Gas Flows Within Structure	95
3.71	Experiment 6 — Gas Concentration	96
3.72	Experiment 7 — Exterior Photographs	97
3.73	Experiment 7 — Instrument Plan	99
3.74	Experiment 7 — Fire Room Photographs	100
3.75	Experiment 7 — Fire Room Layout	100
3.76	Experiment 7 — Vertical Ventilation Openings	101
3.77	Experiment 7 — Actions/Events	102
3.78	Experiment 7 — Fire Room Temperatures	103

3.79	Experiment 7 — Attic Temperatures	103
3.80	Experiment 7 — Remote Temperatures	104
3.81	Experiment 7 — Fire Room Pressures	105
3.82	Experiment 7 — Remote Pressures	106
3.83	Experiment 7 — Gas Flows Within Structure	107
3.84	Experiment 7 — Heat Flux	108
3.85	Experiment 7 — Gas Concentrations	109
3.86	Experiment 8 — Exterior Photographs	110
3.87	Experiment 8 — Instrument Plan	111
3.88	Experiment 8 — Fire Room Photographs.	112
3.89	Experiment 8 — Fire Room Layout	113
3.90	Experiment 8 — Vertical Ventilation Openings	113
3.91	Experiment 8 — Actions/Events	115
3.92	Experiment 8 — Fire Room Temperatures	116
3.93	Experiment 8 — Remote Temperatures	117
3.94	Experiment 8 — Attic Temperatures	118
3.95	Experiment 8 — Fire Room Pressures	118
3.96	Experiment 8 — Remote Pressures	119
3.97	Experiment 8 — Gas Flows Within Structure	121
3.98	Experiment 8 — Heat Flux	122
3.99	Experiment 8 — Gas Concentrations	123
3.100	Experiment 9 — Exterior Photographs	124
3.101	Experiment 9 — Instrument Plan	125
3.102	Experiment 9 — Fire Room Photographs.	126
3.103	Experiment 9 — Fire Room Layout	127
3.104	Experiment 9 — Actions/Events	128
3.105	Experiment 9 — Fire Room Temperature	129
3.106	Experiment 9 — Remote Temperature	130
3.107	Experiment 9 — Remote Temperature	131
3.108	Experiment 9 — Fire Room Pressure	132
3.109	Experiment 9 — Remote Pressures	133
3.110	Experiment 9 — Gas Flows Within the Structure	134
3.111	Experiment 9 — Heat Flux	135
3.112	Experiment 9 — Gas Concentrations	136
3.113	Experiment 10 — Exterior Photographs	137
3.114	Experiment 10 — Instrument Plan	138
3.115	Experiment 10 — Fire Room Photographs	139
3.116	Experiment 10 — Fire Room Layout	140
3.117	Experiment 10 — Actions/Events	141
3.118	Experiment 10 — Fire Room Temperature	142
3.119	Experiment 10 — Remote Temperatures	143
3.120	Experiment 10 — Heat Flux	144
3.121	Experiment 10 — Remote Pressure	145
3.122	Experiment 10 — Gas Flows Within Structure	146
3.123	Experiment 10 — Gas Concentrations	147

3.124	Experiment 11 — Exterior Photographs	148
3.125	Experiment 11 — Instrument Plan	149
3.126	Experiment 11 — Fire Room Photographs	150
3.127	Experiment 11 — Fire Room Layout	151
3.128	Experiment 11 — Actions/Events	153
3.129	Experiment 11 — Fire Room Temperature	154
3.130	Experiment 11 — Remote Temperatures	155
3.131	Experiment 11 — Heat Flux	156
3.132	Experiment 11 — Remote Pressures	157
3.133	Experiment 11 — Gas Flows Within Structure	159
3.134	Experiment 11 — Hallway Flow	160
3.135	Experiment 11 — Gas Concentrations	161
3.136	Experiment 12 — Exterior Photographs	162
3.137	Experiment 12 — Instrument Plan	163
3.138	Experiment 12 — Fire Room Photographs.	164
3.139	Experiment 12 — Fire Room Layout	165
3.140	Experiment 12 — Actions/Events	166
3.141	Experiment 12 — Fire Room Temperature	167
3.142	Experiment 12 — Remote Temperatures	168
3.143	Experiment 12 — Hallway Fire Conditions	169
3.144	Experiment 12 — Heat Flux	170
3.145	Experiment 12 — Remote Pressures	171
3.146	Experiment 12 — Gas Concentrations	172
3.147	Experiment 12 — Gas Flows Within Structure	174
3.148	Experiment 13 — Exterior Photographs	175
3.149	Experiment 13 — Instrument Plan	176
3.150	Experiment 13 — Fire Room Photographs	177
3.151	Experiment 13 — Fire Room Layout	178
3.152	Experiment 13 — Failed Ceiling	178
3.153	Experiment 13 — Actions/Events	180
3.154	Experiment 13 — Fire Room Temperatures	181
3.155	Experiment 13 — Remote Temperatures	182
3.156	Experiment 13 — Fire Room Pressures	183
3.157	Experiment 13 — Remote Pressure	184
3.158	Experiment 13 — Gas Flows Within Structure	185
3.159	Experiment 13 — Heat Flux	186
3.160	Experiment 13 — Gas Concentrations	187
3.161	Experiment 14 — Exterior Photographs	188
3.162	Experiment 14 — Instrument Plan	189
3.163	Experiment 14 — Fire Room Photographs	190
3.164	Experiment 14 — Fire Room Layout	191
3.165	Experiment 14 — Failed Ceiling	191
3.166	Experiment 14 — Actions/Events	193
3.167	Experiment 14 — Fire Room Temperatures	194
3.168	Experiment 14 — Remote Temperatures	195

3.169	Experiment 14 — Fire Room Pressures	196
3.170	Experiment 14 — Remote Pressures	197
3.171	Experiment 14 — Gas Flows Within Structure	198
3.172	Experiment 14 — Heat Flux	199
3.173	Experiment 14 — Gas Concentrations	200
3.174	Experiment 15 — Exterior Photographs	201
3.175	Experiment 15 — Instrument Plan	202
3.176	Experiment 15 — Fire Room Layout	203
3.177	Experiment 15 — Fuel Package Photograph	204
3.178	Experiment 15 — Kitchen Cabinet Layout	205
3.179	Experiment 15 — Actions/Events	206
3.180	Experiment 15 — Fire Room Temperatures	207
3.181	Experiment 15 — Remote Temperatures	208
3.182	Experiment 15 — Fire Room Pressures	209
3.183	Experiment 15 — Remote Pressures	210
3.184	Experiment 15 — Gas Flows within Structure	211
3.185	Experiment 15 — Heat Fluxes	212
3.186	Experiment 15 — Gas Concentrations	213
3.187	Experiment 16 — Exterior Photographs	214
3.188	Experiment 16 — Instrument Plan	215
3.189	Experiment 16 — Fire Room Photographs	216
3.190	Experiment 16 — Fire Room Layout	217
3.191	Experiment 16 — Kitchen Cabinet Layout	218
3.192	Experiment 16 — Horizontal Ventilation Photographs	219
3.193	Experiment 16 — Actions/Events	220
3.194	Experiment 16 — Fire Room Temperatures	221
3.195	Experiment 16 — Remote Temperatures	222
3.196	Experiment 16 — Fire Room Pressures	223
3.197	Experiment 16 — Remote Pressures	224
3.198	Experiment 16 — Gas Flows Within Structure	225
3.199	Experiment 16 — Heat Fluxes	226
3.200	Experiment 16 — Gas Concentrations	227
3.201	Experiment 17 — Exterior Photographs	228
3.202	Experiment 17 — Instrument Plan	229
3.203	Experiment 17 — Fire Room Photographs	230
3.204	Experiment 17 — Fire Room Layout	231
3.205	Experiment 17 — Kitchen Cabinet Layout	231
3.206	Experiment 17 — Actions/Events	233
3.207	Experiment 17 — Fire Room Temperatures	234
3.208	Experiment 17 — Remote Temperatures	235
3.209	Experiment 17 — Remote Temperatures	236
3.210	Experiment 17 — Fire Room Pressures	237
3.211	Experiment 17 — Dining Room Pressures	238
3.212	Experiment 17 — Remote Pressures	239
3.213	Experiment 17 — Gas Flows Within Structure	241

3.214	Experiment 17 — Heat Fluxes	242
3.215	Experiment 17 — Gas Concentrations	243
3.216	Experiment 18 — Exterior Photographs	244
3.217	Experiment 18 — Instrument Plan	245
3.218	Experiment 18 — Fire Room Photographs	246
3.219	Experiment 18 — Fire Room Layout	247
3.220	Experiment 18 — Kitchen Cabinet Layout	247
3.221	Experiment 18 — Actions/Events	249
3.222	Experiment 18 — Fire Room Temperatures	250
3.223	Experiment 18 — Remote First-Floor Temperatures	251
3.224	Experiment 18 — Remote Second-Floor Temperatures	252
3.225	Experiment 18 — First-Floor Pressures	253
3.226	Experiment 18 — Remote Second-Floor Pressures	254
3.227	Experiment 18 — Gas Flows Within Structure	255
3.228	Experiment 18 — Heat Fluxes	256
3.229	Experiment 18 — Gas Concentrations	257
3.230	Experiment 19 — Exterior Photographs	258
3.231	Experiment 19 — Instrument Plan	259
3.232	Experiment 19 — Fire Room Photographs	260
3.233	Experiment 19 — Fire Room Layout	261
3.234	Experiment 19 — Kitchen Cabinet Layout	261
3.235	Experiment 19 — Actions/Events	263
3.236	Experiment 19 — Fire Room Temperatures	264
3.237	Experiment 19 — Remote Temperatures	265
3.238	Experiment 19 — Fire Room Pressures	266
3.239	Experiment 19 — Remote Pressure	266
3.240	Experiment 19 — Gas Flows Within Structure	267
3.241	Experiment 19 — Heat Flux	268
3.242	Experiment 19 — Gas Concentrations	269
3.243	Experiment 20 — Exterior Photographs	270
3.244	Experiment 20 — Instrument Plan	271
3.245	Experiment 20 — Fire Room Photographs	272
3.246	Experiment 20 — Fire Room Layout	273
3.247	Experiment 20 — Kitchen Cabinet Layout	274
3.248	Experiment 20 — Actions/Events	276
3.249	Experiment 20 — Fire Room Temperatures	277
3.250	Experiment 20 — First-Floor Remote Temperatures	278
3.251	Experiment 20 — Second-Floor Remote Temperatures	279
3.252	Experiment 20 — Fire Room Pressures	280
3.253	Experiment 20 — Dining Room Pressures	280
3.254	Experiment 20 — Second-Floor Remote Pressures	282
3.255	Experiment 20 — Gas Flow Within Structure	284
3.256	Experiment 20 — Heat Flux	285
3.257	Experiment 20 — Gas Concentrations	286

4.1	Thermal Operating Classes	291
4.2	Comparison of Thermal Operating Classes with Modern PPE Performance Limits	292
4.3	Method 1 Fire Floor Layouts	296
4.4	Experiment 3 Suppression Effects	297
4.5	Experiment 5 Suppression Effects	298
4.6	Times to CO Concentration Less Than 1200 ppm for Method 1 Experiments	299
4.7	Flow Path Comparison for Experiments 1 and 3	300
4.8	Times in Thermal Operating Classes for Method 1 Experiments	305
4.9	Method 2 Fire Floor Layouts	307
4.10	Ventilation response of Second-Floor Temperatures in Method 2 Experiments	309
4.11	Suppression Effects on Fire Room and Local Temperatures for Experiments 7, 8, and 9	311
4.12	Visibility Outside Fire Room for Vertical Ventilation Experiments 7 and 8	312
4.13	Times in Thermal Operating Classes for Method 2 Experiments	316
4.14	Method 3 Fire Floor Layouts	319
4.15	Hallway Temperature Regrowth in Method 3 Experiments	320
4.16	Occupant Package Temperature Comparison	323
4.17	Times in Thermal Operating Classes for Method 3 Experiments	326
4.18	Method 4 Fire Floor Layouts	328
4.19	Effect of Straight Stream Suppression on Fire Room and Hallway Temperatures	330
4.20	Experiment 13 Failed Ceiling Effectiveness – Visual, Initial	331
4.21	Experiment 14 Failed Ceiling Effectiveness – Visual, Initial	331
4.22	Experiment 13 Failed Ceiling Effectiveness – Visual, Lintel	332
4.23	Experiment 14 Failed Ceiling Effectiveness – Visual, Lintel	333
4.24	Method 4 Occupant FER	334
4.25	Effect of Exterior Suppression Actions on Skin Burn Assessment Packages	335
4.26	Times in Thermal Operating Classes for Method 4 Experiments	337
4.27	Method 5 Fire Floor Layouts	339
4.28	Suppression/Ventilation Effects on Fire Room Temperatures for Method 5	341
4.29	Suppression Effects on Remote Room Temperatures for Method 5	342
4.30	Times in Thermal Operating Classes for Method 5 Experiments	346
4.31	Method 6 Fire Floor Layouts	348
4.32	Suppression/Ventilation Effects on Fire Room Temperatures for Method 6	350
4.33	Suppression Effects on Remote Room Temperatures for Method 6	351
4.34	Times to CO Concentration Less Than 1200 ppm for Method 6 Experiments	353
4.35	Times in Thermal Operating Classes for Method 6 Experiments	356
4.36	FED Values by Experiment	358
4.37	Gas Movement Following Suppression	360
4.38	Increase in Toxic and Thermal Exposure at Occupant Locations in Experiments 11 and 13	361
4.39	Probability and Cumulative Density of Helmet Heat Flux for Firefighter Helmets	363
4.40	Comparison of Thermal Operating Classes with Modern PPE Performance Limits	364
5.1	Water Usage by Suppression Method	366
5.2	Post-Exterior Suppression Kitchen Temperatures for Method 6 Experiments	368

5.3	Post-Exterior Suppression Hallway Temperatures for Method 3 Experiments	369
5.4	Suppression Effects on Fire Room Temperatures	371
5.5	Experiment 3 Stairway Suppression	372
5.6	Fire in Hallway in Experiment 3	372
5.7	Suppression Effects on Remote Temperatures	373
5.8	Ineffective Water Application	373
5.9	Fire in Hallway in Experiment 8	375
5.10	Peak Surface Temperatures vs. Distance From Fire Room	376
5.11	FED at Time of Intervention vs. Distance From Fire Room	377
5.12	FED at time of intervention vs. Elevation	378
5.13	Temperature Change Following Initial Ventilation for Interior Suppression Experiments	381
5.14	CO Recovery Times	383
5.15	Effect of Straight Stream Suppression on Fire Room	385
5.16	Exterior Water Application Comparison: Initial - Experiments 13 and 14	386
5.17	Exterior Water Application Comparison: Lintel - Experiments 13 and 14	387
5.18	Interior Water Dispersion	388
5.19	King Stud	389
5.20	Peak FER Time in Flow Path vs. out of Flow Path	390
5.21	FED increase following Front Door Open	391
5.22	Flow Path Comparison - Experiments 1 and 3	392
5.23	Visibility Comparison at Remote Occupant Location	393
7.1	Building Side Terminology	396

List of Tables

2.1	Bedroom Fire Experiments - Post Suppression Ventilation	5
2.2	Bedroom Fire Experiments - Pre-Suppression Ventilation	6
2.3	Bedroom Fire Experiments - Ventilation Post Exterior Water Flow	7
2.4	Bedroom Fire Experiments - Additional Ventilation for Exterior Fire Control Comparisons	8
2.5	Kitchen Fire Experiments - Interior Suppression with Ventilation Prior to Fire Control	9
2.6	Kitchen Fire Experiments - Exterior Fire Control with Ventilation Post Water Flow	10
2.7	Bedroom Fuels	13
2.8	Kitchen Fuel Package	14
2.9	Kitchen Ignition Package	15
3.1	List of Experiments	17
4.1	Coordinated Method 1 Intervention Times	294
4.2	Coordinated Method 1 Occupant Tenability Assessment Package Locations	295
4.3	Method 1 Tactic Duration and Times to Water Flow	297
4.4	Method 1 Occupant Tenability Estimate	301
4.5	Coordinated Method 1 Pig Skin Temperatures	303
4.6	Thermal Exposure to Nozzle and Officer Firefighter Helmets – Method 1	304
4.7	Coordinated Method 2 Intervention Times	306
4.8	Coordinated Method 2 Occupant Tenability Assessment Package Locations	307
4.9	Coordinated Method 2 Duration(s) Between First Ventilation and Suppression Events	308
4.10	Coordinated Method 2 Occupant Tenability Estimate	313
4.11	Coordinated Method 2 Pig Skin Temperatures	314
4.12	Thermal Exposure to Nozzle and Officer Firefighter Helmets – Method 2	315
4.13	Coordinated Method 3 Intervention Times	318
4.14	Coordinated Method 3 Occupant Tenability Assessment Package Locations	318
4.15	Times and Temperatures Between Exterior and Interior Water	321
4.16	Coordinated Method 3 Occupant Tenability Estimate	322
4.17	Coordinated Method 3 Pig Skin Temperatures	324
4.18	Thermal Exposure to Nozzle and Officer Firefighter Helmets – Method 3	325
4.20	Coordinated Method 4 Occupant Tenability Assessment Package Locations	328
4.21	Coordinated Method 4 Occupant Tenability Estimate	333
4.22	Coordinated Method 4 Pig Skin Temperatures	335
4.23	Thermal Exposure to Nozzle and Officer Firefighter Helmets – Method 4	336

4.24	Coordinated Method 5 Intervention Times	338
4.25	Coordinated Method 5 Occupant Tenability Assessment Package Locations	339
4.26	Coordinated Method 5 Tactic Duration and Times to Water Flow	340
4.27	Coordinated Method 5 Occupant Tenability Estimate	343
4.28	Coordinated Method 5 Pig Skin Temperatures	344
4.29	Thermal Exposure to Nozzle and Officer Firefighter Helmets – Method 5	345
4.30	Coordinated Method 6 Intervention Times	347
4.31	Coordinated Method 6 Occupant Tenability Assessment Package Locations	348
4.32	Coordinated Method 6 Occupant Tenability Estimate	352
4.33	Coordinated Method 6 Pig Skin Temperatures	354
4.34	Thermal Exposure to Nozzle and Officer Firefighter Helmets – Method 6	355
4.35	Helmet Heat Flux Comparison	364
5.1	Water Usage in Fire Attack Study by Suppression Method	365
5.2	Average Water Usage by Method	367

List of Abbreviations

AFG	Assistance to Firefighters Grant program
CO	Carbon monoxide
CO ₂	Carbon dioxide
DHS	Department of Homeland Security
FED	Fractional effective dose
FEMA	Federal Emergency Management Agency
FER	Rate of change of fraction effective dose
IR	Infrared
O ₂	Oxygen
PPA	Positive pressure attack
PPV	Positive pressure ventilation
TIC	Thermal imaging camera
UL	Underwriters Laboratories
UL FSRI	UL Firefighter Safety Research Institute

Abstract

Prior full-scale research with the fire service was primarily designed to isolate specific tactics, most often either ventilation or suppression, which allowed researchers to develop science-based recommendations related to the specific components of fireground operations studied in relatively controlled conditions. The current project went beyond earlier research by conducting twenty experiments in eight acquired, single-family residential structures and that combined fireground tactics to quantify the impact of coordination between ventilation and suppression actions.

This experimental series included second-story bedroom fires (14 experiments) and first-floor kitchen fires (6 experiments). The main control variables studied included the position of initial application of water, the ventilation method, and the timing of ventilation relative to water application. The ventilation tactics examined in these experiments included horizontal, vertical, positive pressure, and hydraulic ventilation, while the suppression tactics included both interior water application and initial exterior water application followed by interior water application.

While some elements of the experiments (e.g. structure floor plan and weather) resulted in increased variability, the lessons learned highlighted the importance of having a systematic approach to the implementation of tactics. Most importantly, there was no meaningful increase in temperature outside of fire rooms when ventilation tactics were executed in coordination with (shortly after or shortly before) the onset of suppression.

The effectiveness of suppression actions in extinguishing the fire were dependent on the ability of those actions to 1) cool surfaces in the fire room and 2) wet unburned fuel. Exterior suppression actions on second-floor bedroom fires resulted in a decrease in temperatures throughout the second floor, followed by regrowth prior to final suppression through interior streams. When exterior suppression was performed on first-floor kitchen fires, where more complete fuel wetting was possible, regrowth was not observed prior to interior suppression. When surface cooling or fuel wetting are not possible due to the elevation of the fire room, missing ceiling, or obstacles, firefighters should consider alternative means of water distribution to improve the effectiveness of suppression actions from outside the fire room.

Suppression actions, whether interior or exterior, generally resulted in a decrease in temperatures and gas concentrations at locations where occupants may potentially be located. Conditions improved most quickly at locations closest in proximity to the inlet of the flow path established between the front door and the fire room. For this reason, opening an exterior door to gain access should be thought of as an important ventilation action, both in terms of its potential to cause fire growth and its potential to improve conditions for potentially trapped occupants. After effective suppression, structure ventilation operations should similarly be cognizant of gas flows, with the aim of establishing flow throughout all areas where occupants may be located.

1 Introduction

The purpose of this study is to improve fire service knowledge of fire dynamics and the impact of their tactics through a better understanding of how suppression and ventilation are coordinated on the fireground in acquired residential structures. This project expands on previous studies led by the UL Firefighter Safety Research Institute (FSRI) that examined the impact of fire service tactics on fire behavior. Those experiments, conducted in purpose-built structures inside the UL large fire laboratory, were specifically designed to study isolated tactics. Specifically, this project expands upon three prior ventilation studies *Impact of Ventilation on Fire Behavior in Legacy and Contemporary Residential Construction* [1], *Effectiveness of Fire Service Vertical Ventilation and Suppression Tactics* [2], and *Effectiveness of Positive Pressure Ventilation* [3] and a prior suppression study, *Study of the Impact of Fire Attack Utilizing Interior and Exterior Streams on Firefighter Safety and Occupant Survival* [4–6], by applying knowledge gained in the laboratory experiments to the streets in the form of eight acquired single-family residential structures. Historically, coordination has been identified as an important aspect of fireground operations in fire service training materials but has not been well defined or explained. Additionally, a lack of coordination with regards to ventilation and suppression has been cited as a contributing factor in several line of duty death (LODD) investigations conducted by the National Institute of Occupational Safety and Health (NIOSH). This study aims to provide the data necessary to understand the parameters of a successful coordinated fire attack to provide knowledge so that firefighters can make better decisions with regards to effectiveness and efficiency on the fireground.

Appropriately coordinating a fire control strategy is critical to success, whether a single crew or several crews are on scene, whether in a rural or urban environment, or whether career or volunteer firefighters are responding to the structure fire. Understanding what makes coordination successful or not is relevant to the entire fire service. As fire departments adapt tactics to the changing fire environment, the tactical changes require an evaluation of the principles of fire service operations; specifically ventilation and suppression. However, departments may lack the data or context to define what successful coordinated fire attack is. It is also a challenge for departments to provide guidance on how to operate effectively while allowing enough room for decision making on the fireground based on the conditions the crews encounter.

There are many fire dynamics variables that can impact coordination on the fireground. Timing is a key component that must be understood if tactics are to be executed in coordination. A tactic such as horizontal ventilation can be very effective in certain areas of a structure but not in others. It can be effective to accomplish a certain task but then be ineffective if not coordinated with another tactic such as interior water flow. Data is needed to understand the science of coordination and how tactics link together to create as positive of an outcome as possible for occupant survivability, firefighter safety, and property preservation.

Using acquired structures, these experiments were designed to bring the laboratory to the street. Several different fire scenarios were tested using tactics that included horizontal, vertical and positive pressure ventilation combined with interior or interior/exterior suppression. Measurements

were taken of gas temperatures, heat flux, flow velocities, differential pressure, and gas concentrations throughout the structures along with standard and infrared video of the experiments. Fuel packages were representative of furnished rooms found in structures across the country. Fuels were consistent across the experimental series so the variations in coordinated methods could be compared. The variables of tactics, timing of tactics, and coordination of tactics were carefully controlled to maximize connections between prior research projects conducted as well as the 20 experiments conducted for this series.

1.1 Objectives

As part of previous DHS AFG funded projects, UL examined horizontal, vertical, and positive pressure ventilation as well as interior or interior/exterior suppression in a ranch style home. These experiments (more than 75) utilized furnishings that produced realistic fires to examine fire service ventilation and fire service suppression practices during ventilation limited fire conditions. To connect the previously studied fire service tactics, a series of experiments was conducted with coordinated tactics. The results of these experiments will be compared to evaluate the effectiveness of coordinated suppression and ventilation in single-family residential structures.

The purpose of this study is:

- To improve fire service knowledge of fire dynamics and the impact of their tactics through a more detailed understanding of how suppression and ventilation are coordinated on the fireground in different configurations of single-family residential structures.
- To expand on previous research studies that examined fire dynamics and fire service tactics and improved firefighter effectiveness and efficiency.
- To provide the data necessary to understand the parameters of a successful coordinated suppression and ventilation so that firefighters have the knowledge to be more effective and efficient on the fireground.

2 Experimental Setup

The goal of this study was to evaluate the coordination of fire suppression and ventilation tactics for a fire in a single-family home. Considering previous UL FSRI research results, the focus of the fire service technical panel was directed to the coordination of fire control strategies for second-floor bedroom fires and first-floor kitchen fires. A series of 20 experiments were developed to evaluate six different coordination methods grouped by the fire location.

The main control variables included the position of initial application of water, the ventilation method, and whether that ventilation was performed prior to or after water was applied to the fire compartment. Although several more strategies were discussed, the selected methods were deemed to represent the majority of options that the initial arriving crews have when presented with a second-floor bedroom fire or first-floor kitchen fire in a single-family structure. The following sections address these tactics grouped by what was termed a coordination method. Additionally, two experiments were conducted to look at the impact of a missing ceiling on the effectiveness of exterior fire control.

The use of acquired structures added variables such as different hose stretch distances or variations on ventilation timing; variables that are also part of actual fire responses. Note: That after the results for each of the experiments are presented, the impact of the variations within each coordination method are discussed.

2.1 Second Floor Bedroom Fires

Each fire was ignited with an electric match located on the arm of an upholstered chair in a second-floor bedroom. The windows to the room were removed prior to ignition to ensure repeatable fire growth and development and the interior door between the fire room and the rest of the structure was left open. The fire was permitted to flashover the bedroom, and reach a post-flashover state. After the fire had been in a post-flashover state for several minutes, fire service intervention was initiated. The general sequence of operations used for the coordinated bedroom fire control strategies are listed in the sections below.

2.1.1 Method 1 - Interior Suppression with Ventilation Post Fire Control

The experiments in Method 1 were designed to evaluate the effectiveness of interior suppression on a second-floor bedroom fire with ventilation occurring once the suppression crew applied water into the fire compartment. The ventilation tactic was varied to evaluate the different options for removing smoke after initial fire control. After the fire had reached a post-flashover state for several minutes, fire department intervention was initiated, following the six tasks utilized in Method 1 listed below:

1. Front door open
2. Suppression crew enters—10 s after front door open
3. Suppression crew advances to the fire room flowing as determined by the nozzle firefighter, with a 150 gpm combination nozzle set to straight stream
4. Suppression crew enters bedroom for contents suppression
5. Additional post suppression ventilation includes one of the following options:
 - none
 - hydraulic
 - vertical
 - additional horizontal
 - positive pressure
6. Overhaul fire room and structure as deemed necessary by company officer

Table 2.1 lists the experiment, structure, and ventilation method for the six experiments conducted using this coordinated attack method.

Table 2.1: Bedroom Fire Experiments - Post Suppression Ventilation

Experiment	Structure	Ventilation
1	1492 Dayton Xenia Rd.	None
2	2401 Wapakoneta Ave.	Hydraulic
3	1492 Dayton Xenia Rd.	Vertical
4	2401 Wapakoneta Ave.	Additional Horizontal
5	2401 Wapakoneta Ave.	Positive Pressure
6	1030 Hilltop Rd.	Door Control

2.1.2 Method 2 - Interior Suppression with Ventilation Prior to Fire Control

The experiments in Method 2 were designed to evaluate the effectiveness of ventilation actions occurring prior to interior suppression of a second-floor bedroom fire. After the fire had reached a post-flashover state for several minutes, fire department intervention was initiated, following the six tasks utilized in Method 2 listed below:

1. Front door open
2. Suppression crew enters—10 s after front door open
3. Additional ventilation includes one of the following options:
 - vertical over fire room
 - vertical remote from fire room
 - positive pressure
4. Suppression crew advances to the fire room flowing as determined by the nozzle firefighter, with a 150 gpm combination nozzle set to straight stream
5. Suppression crew enters bedroom for contents suppression
6. Overhaul fire room and structure as deemed necessary by company officer

Table 2.2 lists the experiment, structure, and ventilation method for the three experiments conducted using this coordination method.

Table 2.2: Bedroom Fire Experiments - Pre-Suppression Ventilation

Experiment	Structure	Ventilation
7	201 Water St.	Vertical Over Fire Room
8	201 Water St.	Vertical Remote to Fire Room
9	1030 Hilltop Rd.	Positive Pressure Attack

2.1.3 Method 3 - Exterior Fire Control with Ventilation Post Initial Water Flow

The experiments in Method 3 were designed to evaluate the effectiveness of an initial exterior suppression action directed into a second-floor bedroom fire and subsequent transition to interior suppression with ventilation occurring as the suppression crew entered the structure. The ventilation tactic varied as described below:

1. Exterior suppression with a straight stream pattern at a steep angle through fire room window
2. Front door open
3. Additional ventilation includes one of the following options:
 - none
 - positive pressure
 - additional horizontal
4. Suppression crew enters structure and advances to the fire room flowing as determined by the nozzle firefighter, with a 150 gpm combination nozzle set to straight stream
5. Suppression crew enters bedroom for contents suppression
6. Overhaul fire room and structure as deemed necessary by company officer

Table 2.3 lists the experiment, structure, and ventilation method for the three experiments conducted using this coordination method.

Table 2.3: Bedroom Fire Experiments - Ventilation Post Exterior Water Flow

Experiment	Structure	Ventilation
10	230 N. Walnut St.	None
11	230 N. Walnut St.	Positive Pressure
12	230 N. Walnut St.	Additional Horizontal

2.1.4 Method 4 - Exterior Fire Control Effectiveness

The experiments in Method 4 were designed to evaluate the effectiveness of two different exterior water flow techniques occurring after failure of the ceiling in a second-floor bedroom fire. The first exterior water flow technique evaluated a straight stream, steep angle directed off the ceiling of the fire room (without any sheathing). The second exterior water flow technique evaluated a straight stream, steep angle directed off the window header of the fire room, referred to as a “lintel hit.” No additional firefighter ventilation occurred during the course of the experiment. Upon the fire having reached post-flashover conditions, the bedroom ceiling was dropped using a remote release and fire department intervention was initiated, following the seven tasks utilized in Method 4 listed below:

1. First exterior water flow—straight stream, steep angle
2. Allow fire to rebuild for several minutes
 - If fire recovers, proceed to 3
 - If fire does not recover, proceed to 4
3. Second exterior water flow—lintel (window header) hit
4. Front door open
5. Suppression crew advances to the fire room flowing as determined by the nozzle firefighter, with a 150 gpm combination nozzle set to straight stream
6. Suppression crew enters bedroom for contents suppression
7. Overhaul fire room and structure as deemed necessary by company officer

Table 2.4 lists the experiment, structure and ventilation for the two experiments conducted using this method.

Table 2.4: Bedroom Fire Experiments - Additional Ventilation for Exterior Fire Control Comparisons

Experiment	Structure	Ventilation
13	1492 Dayton Xenia Rd.	None
14	1030 Hilltop Rd.	None

2.2 First Floor Kitchen Fires

First-floor kitchen fuel packages were ignited with an electric match. Two kitchen windows were removed prior to ignition to ensure repeatable fire growth and development. The fire was permitted to flashover the kitchen, and reach a post-flashover state. At this point the fire service intervention was initiated. The general sequence of operations used for coordinated first-floor kitchen fire control strategies are listed in the sections below.

2.2.1 Method 5 - Interior Suppression with Ventilation Prior to Fire Control

The experiments in Method 5 were designed to evaluate the effectiveness of interior suppression of a first-floor kitchen fire with ventilation occurring immediately before the suppression crew applied water into the fire compartment. After the fire had reached a post-flashover state for several minutes, fire department intervention was initiated, following the five tasks utilized in Method 5 listed below:

1. Front door open
2. Ventilation occurs with one of the following options:
 - none
 - additional horizontal
 - positive pressure
3. Suppression crew advances to the fire room flowing as determined by the nozzle firefighter, with a 150 gpm combination nozzle set to straight stream
4. Suppression crew enters kitchen for contents suppression
5. Overhaul fire room and structure as deemed necessary by company officer

Table 2.5 lists the experiment, structure, and ventilation method for the three experiments conducted using this coordination method.

Table 2.5: Kitchen Fire Experiments - Interior Suppression with Ventilation Prior to Fire Control

Experiment	Structure	Ventilation
15	775 Hilltop Rd.	None
16	773 Hilltop Rd.	Additional Horizontal
17	230 N. Walnut St.	Positive Pressure

2.2.2 Method 6 - Exterior Fire Control with Ventilation Post Initial Water Flow

Method 6 is defined as an initial exterior suppression of a first-floor kitchen fire and subsequent transition to an interior suppression with ventilation occurring as the suppression crew enters the structure. After the fire had reached a post-flashover state for several minutes, fire department intervention was initiated, following the six tasks utilized in Method 6 listed below:

1. Exterior suppression with a straight stream pattern at a steep angle through fire room window
2. Front door opens
3. Additional ventilation occurs with one of the following options:
 - none
 - additional horizontal
 - positive pressure
4. Suppression crew advances to kitchen flowing as determined by the nozzle firefighter, with a 150 gpm combination nozzle set to straight stream
5. Suppression crew enters kitchen for contents suppression
6. Overhaul fire room and structure as deemed necessary by company officer

The experiment number, structure, and ventilation method for the three experiments conducted using this coordination method are listed in Table 2.6.

Table 2.6: Kitchen Fire Experiments - Exterior Fire Control with Ventilation Post Water Flow

Experiment	Structure	Ventilation
18	1030 Hilltop Rd.	None
19	732 Broadway Ave.	Additional Horizontal
20	1492 Dayton Xenia Rd.	Positive Pressure

2.3 Instrumentation

The structures in these experiments were instrumented to measure gas temperature, heat flux, differential pressure, gas concentrations, and hose stream flow rates. Instruments utilized during the experiments included thermocouples, gas analyzers, pressure transducers, water flow meters, and heat flux gauges.

Gas temperatures were measured with 0.05 in. bare-bead, Chromel-Alumel (type K) thermocouples and 0.0625 in. inconel sheathed thermocouples. Small diameter thermocouples were used during these experiments to limit the impact of radiative heating and cooling. The total expanded uncertainty associated with the temperature measurements from these experiments is estimated to be $\pm 15\%$ as reported by researchers at NIST [7, 8]. Thermocouples were installed throughout the structures in specific locations in each compartment and specific hallways, which can be found on the floor plans for each of the experiments discussed in Section 3. In each location, thermocouples were installed as a vertical array. Unless otherwise noted, the array consisted of eight thermocouples with the top thermocouple in each array located 1 in. below the ceiling with the remaining seven thermocouples spaced at 1 ft intervals (1 ft below ceiling, 2 ft below ceiling ... 7 ft below ceiling). For structures where there were nine foot ceilings, the array included an additional thermocouple.

Pressure measurements were made using differential pressure sensors to determine pressure changes relative to ambient (outside the structure) conditions. Three, quarter-inch copper pressure taps were installed 1 ft off the wall, as defined in each structure instrumentation plan, and connected to the one side of the differential transducer. The other side was exposed to ambient conditions. At each location, pressure was measured 1 ft, 4 ft, and 7 ft below the ceiling. The differential pressure sensors had an operating range of ± 125 Pa. The total expanded uncertainty associated with pressure measurements obtained from the transducers is estimated as $\pm 10\%$ [9].

In each experiment, two occupant packages were placed in the structure. Occupant packages were composed of a cluster of heat flux, gas concentration, and temperature sensors combined with a skin burn assessment package intended to evaluate the potential for skin burns and toxic exposure at a specific location within a structure. The skin burn assessment packages consisted of pig (porcine) skin samples (a surrogate for the epidermis and dermis of human skin) placed on an ethylene propylene diene monomer (EPDM) slab (a surrogate for the subcutaneous fat layer). Temperature was measured on the exposed surface and between the bottom of the porcine sample and EPDM slab for each sample. Additionally, air temperature surrounding the samples and the temperature of the water bath were collected throughout each experiment.

Total heat flux measurements were made with water-cooled Schmidt-Boelter gauges. The heat flux gauges were oriented vertically and installed at one of three elevations, 1 ft and either 3 ft or 5 ft above the floor. Results from an international study on total heat flux gauge calibration and response demonstrated that the uncertainty of a Schmidt-Boelter gauge is typically $\pm 8\%$ [10].

Gas concentration sampling ports were installed in the structures. The sampling ports consisted of 3/8 in. stainless steel tubing within the structure. Once outside the structure, the sample was filtered through a coarse, 2 micron paper filter before being drawn through a condensing trap to remove moisture. At the condensate trap exit, the sample line transitioned from stainless steel to polyethylene tubing for flexibility. Upstream of the analyzer the sample passed through a fine, 1 micron filter. To minimize transport time through the system, samples were pulled from the structure through the use of vacuum/pressure diaphragm pump rated at 0.75 CFM. Gas samples were analyzed through the use of oxygen (paramagnetic alternating pressure) and combination carbon monoxide/carbon dioxide (non-dispersive infrared) analyzers. The gas sampling instruments used

throughout the series of tests discussed in this report have demonstrated a relative expanded uncertainty of $\pm 1\%$ when compared to span gas volume fractions [11]. Given the non-uniformities and movement of the fire gas environment and the limited set of sampling points in these experiments, an estimated uncertainty of $\pm 12\%$ is applied to the results [12].

Hoseline water flow measurements were obtained from electromagnetic flow meters. A flow meter was installed downstream of the engine but upstream of the nozzle, at a coupling, to monitor the flow of water through the hoseline. A 2 in. flow meter was attached to the primary hoseline while a 1.5 in. flow meter was attached to the secondary hoseline, if one was used. Flow meters were used prior to the experiment to set flow rates at approximately 150 gpm, to identify periods of water flow, and to measure the cumulative water use over the course of the experiment. The standard uncertainty associated with water flow rate measurements is $\pm 11\%$. See Appendix A for methodology employed to determine standard uncertainty.

2.4 Fuel Packages

A consistent fuel package was used in the room of origin for all bedroom and kitchen fire scenarios.

2.4.1 Bedroom Fuel Package

Bedroom fuel packages included a sofa chair, a steel queen size bed frame, a queen size box spring, a queen size mattress, comforter, two pillows, a head board, a night stand, lamp, dresser, and an end table. During Experiments 13 and 14 only, the fuel package also contained a sofa to prolong the burn duration. Table 2.7 provides the dimensions and weights of each item. The items were arranged in the space based on the configuration of the room. In bedrooms where no carpet was present, carpet and padding were added over the existing floors. For photographs of representative bedroom fuel packages, see Figure 2.1.

Table 2.7: Bedroom Fuels

Furniture	Length(ft)	Width(ft)	Height(ft)	Weight(lbs)
Bed Frame	5.6	6.3	0.7	29.5
Box Spring	6.4	4.7	0.8	46.5
Mattress	6.8	5.1	0.8	57.5
Nightstand	1.4	1.3	2.0	35.1
Dresser	2.7	1.8	2.5	120*
Sofa Chair	3.8	3.3	3.2	92.6
Sofa	7.4	3.2	3.1	107.9
Picture Frame	3.4	0.1	2.6	24.7
Head Board	4.5	0.1	1.7	27.3
Lamp	0.5	0.4	2.1	8.8
Lamp Shade	1.5	1.0	0.9	0.7

* Weight is approximate



Figure 2.1: Representative bedroom fuel package containing bed frame, headboard, box spring, mattress, and associated bedding as well as a nightstand, dresser, sofa chair, lamp and shade, and pictures.

2.4.2 Kitchen Fuel Package

Kitchen fuel packages utilized built-in cabinetry (specific to each structure) and a dining room table, two chairs, a refrigerator, and a range. These items were arranged in the space based on the configuration of the room. In Experiments 15 and 16 the dining room table and chairs were located in an adjacent room to the kitchen (flex space or dining room, respectively). To provide a source fire to ignite these large fuel objects, an ignition package was added. This ignition package included a coffee maker (except during Experiment 18), bag of potato chips, and paper towel rolls located on a counter top beneath hanging cabinets. The hanging cabinets were left ajar exposing paper cups. Paper towel rolls were placed within the kitchen, on the refrigerator, stove, or atop cabinets, to

further increase the fuel load and provide an indication of flashover conditions. For photographs of representative kitchen fuel package, see Figures 2.2. See Table 2.8 for the dimensions and weights of each item. For cabinetry layout and dimensions as well as general fuel package configuration see each individual experiment write up in Section 3.



Figure 2.2: Representative kitchen fuel package containing cabinetry, a refrigerator, a range, a dining room table, two chairs, and ignition fuel package of a coffee maker, bags of potato chips, and paper towel rolls.

Table 2.8: Kitchen Fuel Package

Kitchen Appliances	Length(ft)	Width(ft)	Height(ft)	Weight(lbs)
Refrigerator	2.6	2.5	5.5	201.7
Range	2.3	2.5	3.6	155.0
Coffee Maker	0.8	0.6	0.9	2.5
Table	4.3	2.2	3.0	58*
Chair	1.8	1.6	3.1	16*

* Weight is approximate

Table 2.9: Kitchen Ignition Package

Kitchen Fuels	Quantity per Experiment					
	15	16	17	18	19	20
Cups	1250	-	1250	1250	1250	1250
Paper Towels	10	14	24	30	16	31
Bag of Potato Chips	-	1 L	1 L	9 S	1 L	1 L

L - large bag of potato chips

S - small bag of potato chips

3 Results

To evaluate the coordination of suppression and ventilation tactics in a single-family home, experiments were conducted in both second-floor bedrooms and first-floor kitchens. A series of 20 experiments were conducted to evaluate six different coordination methods as described in Section 2. To focus on coordinated fire suppression methodologies, the fire service technical panel narrowed the tactical choices for the experiments into three broad categories. The main variables included the position of initial application of water, the ventilation method, and whether that ventilation was performed prior to or after water was applied to the fire compartment. The selected methods were deemed to represent the typical options that the initial arriving crews have when presented with a second-floor bedroom fire or a first-floor kitchen fire in a single-family structure. Additionally, two experiments were conducted to look at the impact of a missing ceiling on the effectiveness of the initial exterior suppression.

UL FSRI partnered with two fire departments to complete these experiments: the City of Sidney Fire Department and the Beavercreek Township Fire Department. Both departments had identified single-family houses slated for demolition that were made available for fire research experiments. In total, 20 full-scale fire experiments were conducted across eight houses. Table 3.1 provides a list of the structures and the experiments conducted in each structure.

To comply with regional and national regulations, asbestos abatement was performed in accordance with the authority having jurisdictions. In some homes, asbestos abatement removed components which would have an impact on the outcome of the fire experiments. In these instances, components were replaced with similar non-asbestos containing materials. Where the component removed was deemed through an engineering assessment not to play a significant role in the experiment, the component was not replaced.

For consistency, some interior alterations were performed. Where necessary, walls were added to create similar room sizes. Additionally, windows were replaced or covered to maintain consistent ventilation area and number of openings. The following sections, as listed in Table 3.1, describe the fire dynamics of each of the experiments.

Table 3.1: List of Experiments

Exp	Fire Location & Suppression	Ventilation	Section
1	Bedroom - Interior Method #1	None	3.1
2		Hydraulic	3.2
3		Vertical	3.3
4		Horizontal	3.4
5		Positive Pressure	3.5
6		Door Control	3.6
7	Bedroom - Interior Method #2	Vertical	3.7
8		Vertical	3.8
9		Positive Pressure	3.9
10	Bedroom - Transitional Method #3	None	3.10
11		Positive Pressure	3.11
12		Horizontal	3.12
13	Bedroom - Transitional Method #4	None	3.13
14		None	3.14
15	Kitchen - Interior Method #5	None	3.15
16		Horizontal	3.16
17		Positive Pressure	3.17
18	Kitchen - Transitional Method #6	None	3.18
19		Horizontal	3.19
20		Positive Pressure	3.20

Several fire department interventions occurred during each experiment. A list of interventions is provided for each experiment and included events such as suppression crew movement, ventilation, and water flow. Times of suppression crew movement and ventilation were recorded as they occurred and were verified from video analysis. Water flow was measured and recorded by a flow meter attached to the primary hoseline (interior suppression) or the primary and secondary hose-line (exterior followed by interior suppression). The data collected from this flow meter for each experiment has been depicted on subsequent graphs throughout this section as blue vertical bars indicating when water was flowing. Figure 3.1 provides an example of typical water flow data collected from the flow meter along with the associated fire department interventions.

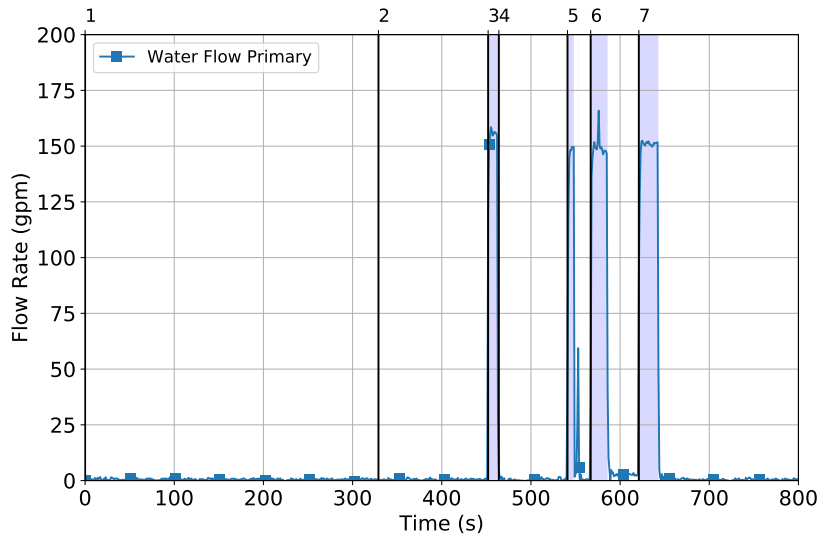

	Action/Event	Time (s)
1	Ignition	0
2	Flashover	329
3	Exterior Water in Bedroom 1 Window	452
4	Front Door Open	464
5	Flow from Top of Stairs	541
6	Flow from Doorway	567
7	Suppression Crew Entered Fire Room	621

Figure 3.1: Flowmeter data obtained from Experiment 10 illustrate how data is presented on subsequent graphs.

Bedroom Fires Method 1

3.1 Experiment 1 — Interior Suppression without Additional Ventilation

Experiment 1 was conducted to evaluate interior suppression without additional ventilation; this was the control experiment for Coordination Method 1. A two-story, 2,100 sq ft, wood frame structure at 1492 Dayton Xenia Road in Xenia, Ohio, was instrumented to conduct a second-floor bedroom fire experiment. The four exterior sides of the structure appear in Figure 3.2. The structure was stick-built with rough cut lumber framing and wood-slat siding. The foundation was a mix of concrete block and stone. The hip-style roof was constructed using 1 in.-by-6 in. sheathing covered with asphalt shingles. Detailed dimensioned drawings for the first and second story appear in Appendix Figures B.14 and B.15, respectively.



(a) Side A



(b) Side B



(c) Side C



(d) Side D

Figure 3.2: Exterior photos of the structure for Experiment 1.

The first-floor of the structure had an entryway, living room, dining room, kitchen, and stairwell

to the second-floor. The second-floor had three bedrooms. These areas formed the experimental volume. The structure was instrumented for temperature, pressure, heat flux, IR, and standard video to capture the fire dynamics during experimentation. Instrumentation was also installed to characterize the potential for skin burns and occupant toxic exposure during the experiment. Figure 3.3 shows the layout of the first and second-floors with the instrumentation locations.

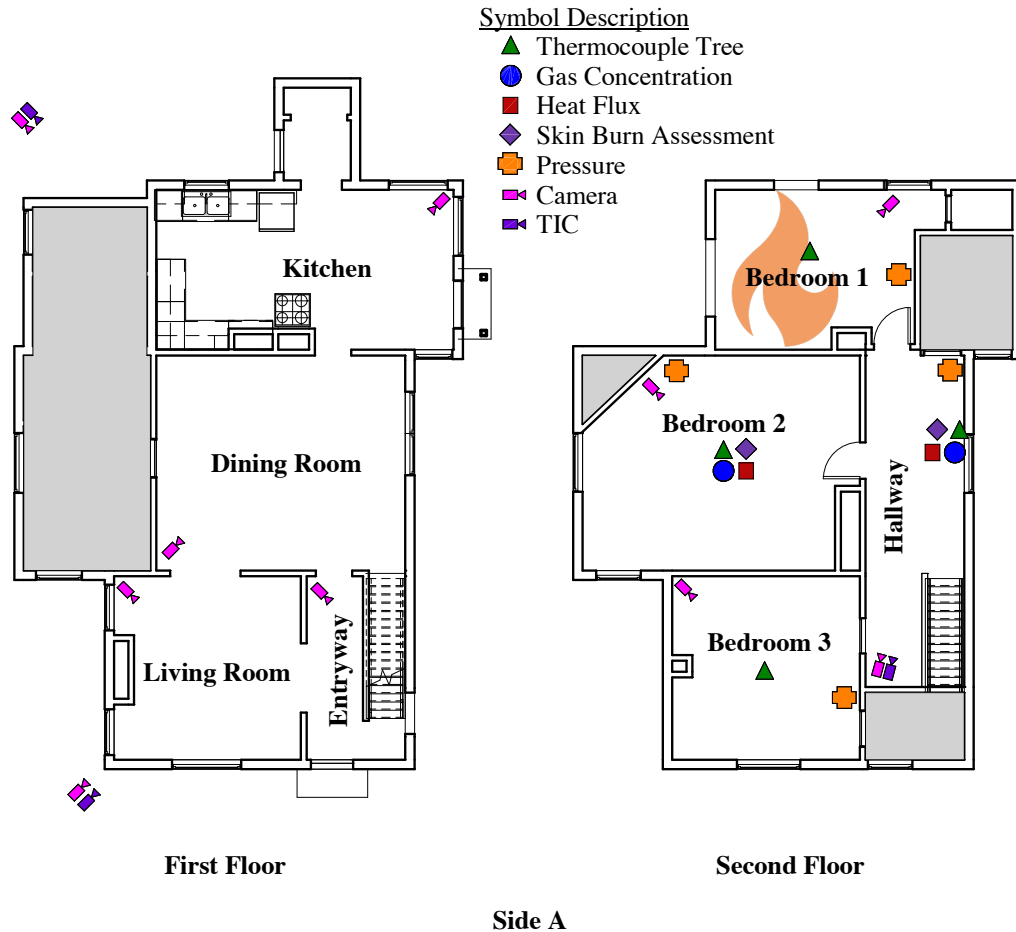

Figure 3.3: Instrumentation and floor plan for Experiment 1. The gray areas were isolated from the remainder of the structure and utilized as space for instrumentation.

Bedroom 1, the fire room, was furnished with the bedroom fuel package described in Section 2.4.1. Photographs of bedroom 1 prior to ignition are presented in Figure 3.4. A dimensioned layout of the fire room is included in Figure 3.5.



(a) A/B Corner



(b) B/C Corner

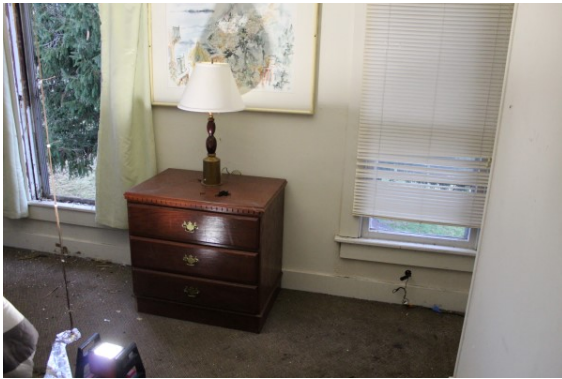

(c) Side C Wall

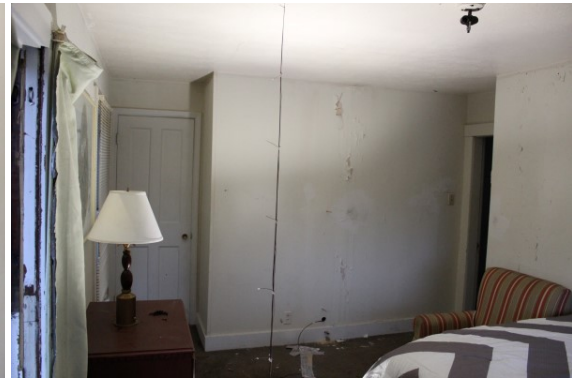

(d) Side D Wall

Figure 3.4: Interior photographs of fire room for Experiment 1.

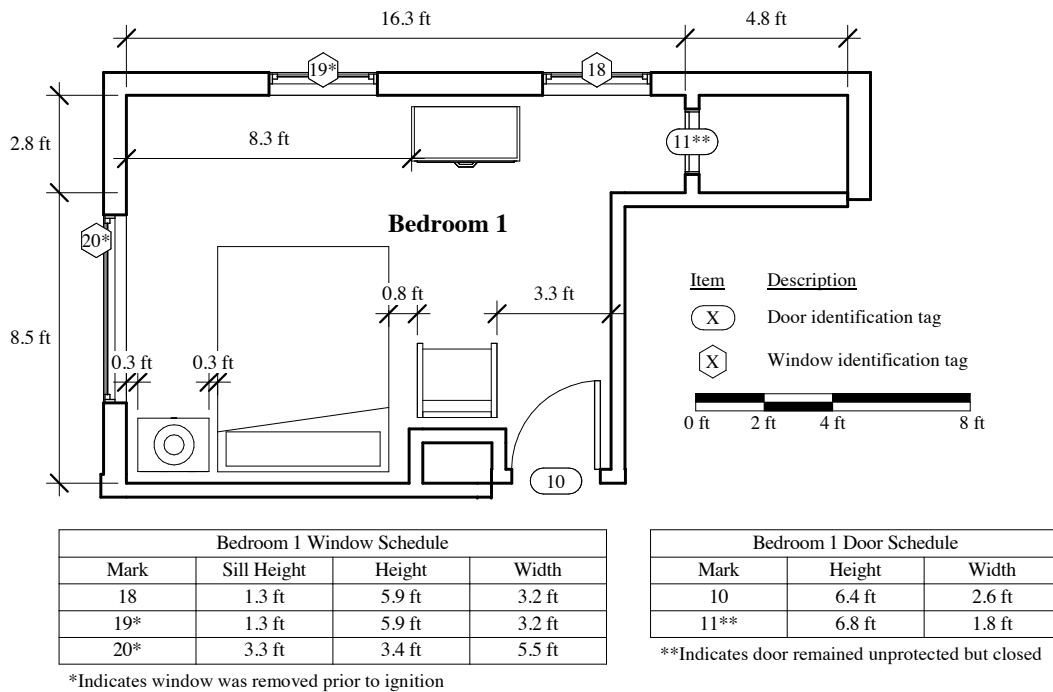

Figure 3.5: Fire room layout for Experiment 1.

Experiment 1 was conducted to examine interior suppression without additional ventilation to establish baseline conditions for the Method 1 experiments. To replicate a similar volume of space found in other experiments, bedroom 3 remained closed throughout the experiment. To ensure repeatable fire growth and a sufficient oxygen supply for flashover, the side C and side D windows (labeled 19 and 20 in Figure 3.5) were removed prior to ignition. Figure 3.6 shows the sequence of events with an isometric image of the structure.

The fire in Experiment 1 was initiated by ignition in the upholstered chair next to the bed ($t = 0$ s). Flames were first visible from the side B window (labeled 20 in Figure 3.5) at 260 s (4:20) post ignition and were first visible from the side C window (labeled 19 on Figure 3.5) at 270 s (4:30) post ignition. At 275 s (4:34) post ignition, flames began continuously venting from both windows. The fire grew and reached flashover at 278 s (4:38) post ignition. After flashover, flames were present from the second side C window (labeled 18 in Figure 3.5) at 324 s (5:24) and remained until fire department interventions occurred.

The first fire department intervention in Experiment 1 was the opening of the front door, which occurred 359 s (5:59) post ignition. Once the door was opened, the suppression crew advanced up the stairway with a 1.75 in. hoseline with a combination nozzle set to straight stream. The first water application occurred 378 s (6:18) from ignition for a duration of 10 s. After the initial water application from the stairs, the suppression crew opened the line and advanced toward the fire room while flowing at 394 s (6:34). The nozzle firefighter continued to flow in the doorway of the fire room until approximately 450 s (7:30) post ignition (56 s duration), after which they advanced

into the fire room to complete suppression. The total tactic time from initial ventilation (front door open) to suppression was 35 s (00:35). The total water flowed for initial suppression was 136 gal, which does not include the additional water used during mop-up operations. Figure 3.6 indicates the time and sequencing of events during Experiment 1 with an isometric image of the structure.

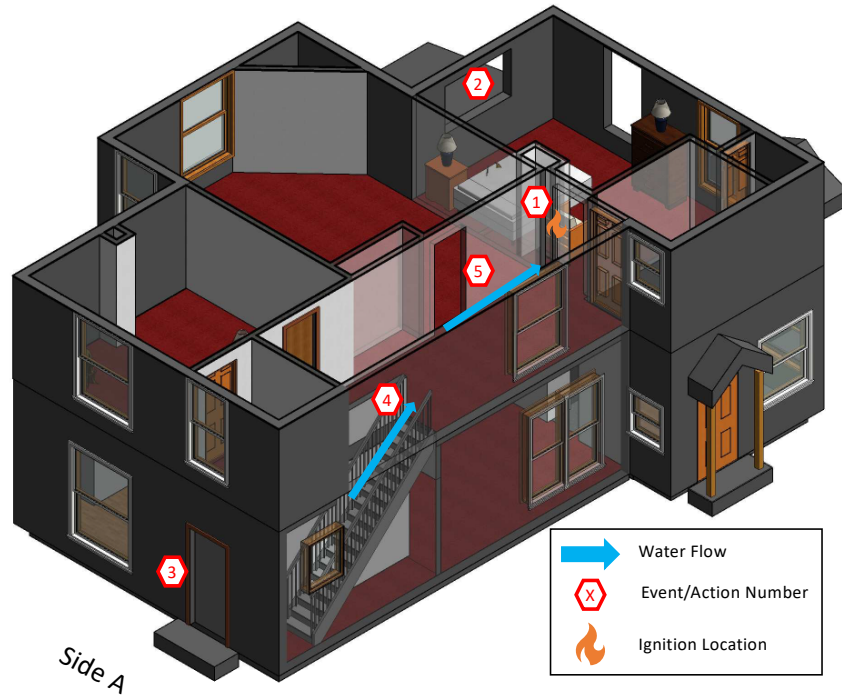

Action/Event	Time (mm:ss)	Time (s)
1 Ignition	00:00	0
2 Flashover	04:38	278
3 Front Door Open	05:59	359
4 Flow from Stairs	06:18	378
5 Flow and Move to Fire Room	06:34	394
6 Flow from Fire Room Doorway	06:59	419

Figure 3.6: Time and sequence of actions and events for Experiment 1.

The time history of the fire room temperature variations are presented in Figure 3.7. As smoke began leaving the side C window 100 s post ignition, temperatures nearest the ceiling (5 ft and above) increased. Temperatures at all elevations began to increase around 200 s post ignition as the chair became fully involved. At approximately 278 s post ignition, fire room temperatures increased beyond 1100 °F, indicating flashover. Temperatures remained elevated until interior suppression began at 376 s, whereafter, temperatures decreased.

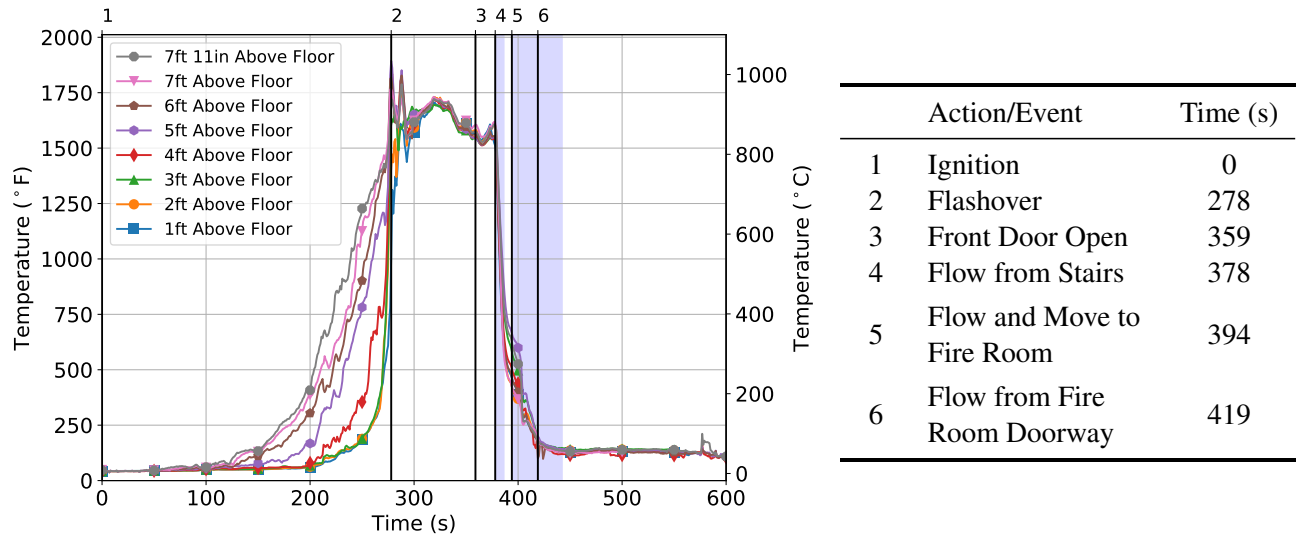

Figure 3.7: Fire room (bedroom 1) temperatures for Experiment 1. Blue vertical bars indicate time and duration of water flow.

Note: The second temperature spike in the fire room, which occurred approximately 10 s after the room transitioned to flashover. During the experiment, there was a sustained 11 mph wind in the direction of the open side B window (marked by 20 in Figure 3.5). Images presented in Figure 3.8 qualitatively show the impact of the wind on fire behavior as the room transitioned to flashover, as well as 5 s and 10 s later.



(a) Fire Room at Flashover

(b) Fire Room at 5 s Post-Flashover



(c) Fire Room at 10 s Post-Flashover

Figure 3.8: Exterior still images from the B/C corner show the impact of wind for Experiment 1.

At the time of flashover, fire was visible through both open fire room windows as shown in Figure 3.8a. Five seconds after flashover as the wind speed increased, exhaust flow from the side B window was suppressed (see Figure 3.8b). The wind gusts continued for several more seconds as indicated in Figure 3.8c by the lack of exhaust out of the side B window and increased flow from the side C compared to Figure 3.8a. The blockage of the exhaust flow led to an increase in pressure and therefore transport of combustion gases through the structure.

The room remained in a post-flashover state throughout the first fire department intervention, which was the opening of the front door at 359 s (5:57) post ignition. The initial water application from the stairway (Action 4) was effective at reducing temperatures in the fire room (see Figure 3.7). The subsequent suppression action of flowing and moving toward the fire room further decreased the temperatures in the fire room and extinguished the fire.

When the fire room transitioned to flashover, temperatures in open areas of the second-floor on the structure also increased, as shown by data from the three locations in Figure 3.9. The highest temperatures observed in adjacent spaces were in the hallway. Hallway temperatures peaked approximately 20 s after the fire room transitioned to flashover as the products of combustion flowed from the fire room throughout the second-floor. The peak ceiling temperatures at this location exceeded 1100 °F, which coincided with the second peak in fire room temperatures. At the time of fire department intervention, the temperatures were stratified with the temperatures 5 ft and above in excess of 600 °F and the temperatures 3 ft and below at less than 250 °F. The initial water

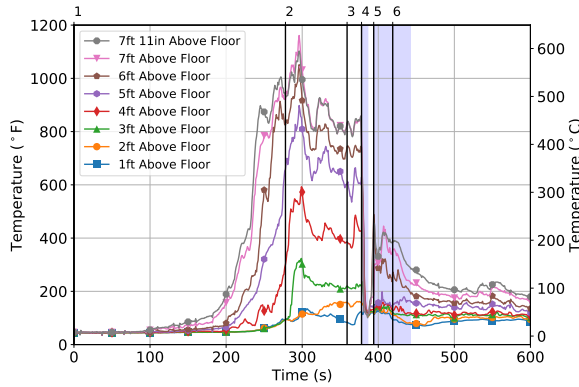

(a) Hallway Temperatures

	Action/Event	Time (s)
1	Ignition	0
2	Flashover	278
3	Front Door Open	359
4	Flow from Stairs	378
5	FF Flow and Move to Fire Room	394

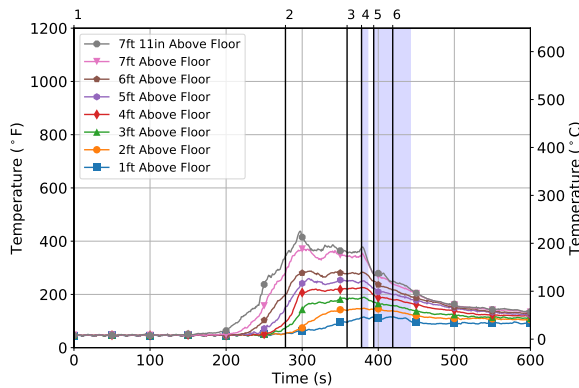

(b) Bedroom 2 Temperatures

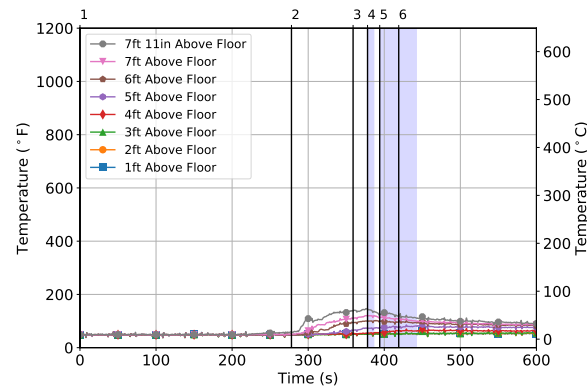

(c) Bedroom 3 Temperatures

Figure 3.9: Second-floor temperatures for Experiment 1. Blue vertical bars indicate time and duration of water flow.

application from the stairs decreased the hallway temperatures at all elevations. Ceiling temperatures (6 ft and higher) re-elevated once the flow stopped, increasing to between 300 °F and 400 °F. After the suppression crew moved down the hallway and into the fire room while flowing water, the hallway temperatures decreased. Temperatures at all elevations decreased below 200 °F at approximately 500 s post ignition (160 s after the front door was opened).

The temperatures in bedroom 2 followed a similar trend to those in the hallway, although the magnitude of the temperatures was not as high. The effect of the initial stairway suppression was not as notable as in the hallway. The temperatures in bedroom 3 were significantly less than any of the other locations on the second-floor because of the closed door to this room—they remained under 200 °F over the duration of the experiment.

The heat flux at the locations in the hallway and bedroom (see Figure 3.10) showed response profiles similar to the temperatures at the respective locations. Heat flux was measured in the hallway at 1 ft and 3 ft above the floor and in bedroom 2 at 1 ft above the floor. The peak heat fluxes in the hallway both occurred prior to fire department intervention, at approximately the same time as flashover. Peak heat fluxes measured were approximately 5 kW/m² and 13 kW/m² at the

1 ft and 3 ft elevations, respectively. After this peak, the heat fluxes decreased below 2 kW/m^2 at the 1 ft level and below 7 kW/m^2 at the 3 ft level at the time the front door was opened. There was an increase in heat flux at both elevations following the front door being opened, with local peaks of 3 kW/m^2 at 1 ft and 7.5 kW/m^2 at 3 ft. Following water flow from the stairs, the heat flux dropped at both elevations, but the 3 ft elevation increased back to near pre-suppression values. Once the suppression crew reached the fire room doorway, the heat flux decreased below 2 kW/m^2 at both elevations for the remainder of the experiment. The peak heat fluxes measured in bedroom 2 were significantly less than those measured in the hallway, with a peak of 1.5 kW/m^2 .

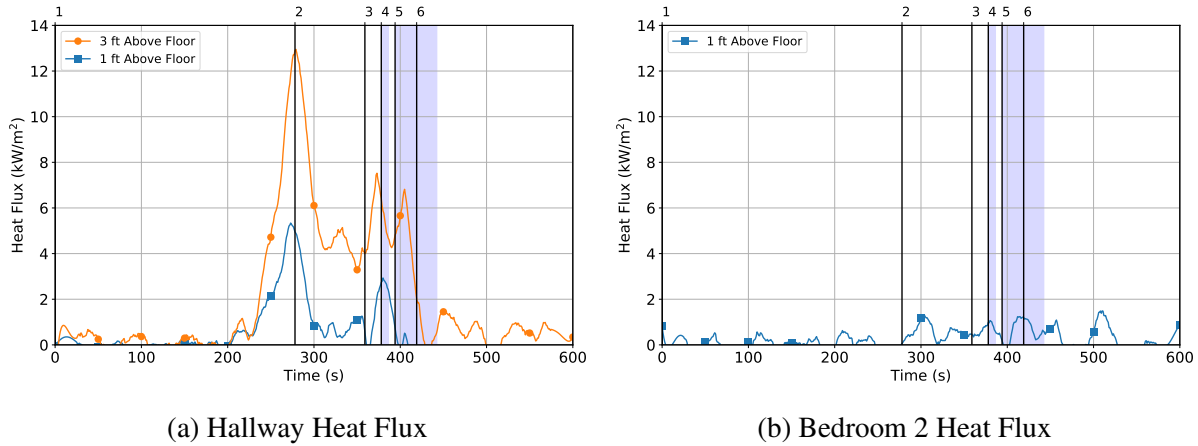

	Action/Event	Time (s)
1	Ignition	0
2	Flashover	278
3	Front Door Open	359
4	Flow from Stairs	378
5	Flow and Move to Fire Room	394
6	Flow from Fire Room Doorway	419

Figure 3.10: Heat flux versus time in the hallway and bedroom 2 for Experiment 1. Blue vertical bars indicate time and duration of water flow.

The pressures within bedroom 1 were impacted by both the growth of the fire and the wind. As the fire grew, the 4 ft and 7 ft pressures in the fire room (see Figure 3.11) began to increase, which was consistent with products of combustion filling the top portion of the fire room. At the same time, the 1 ft pressure began to decrease as fresh air was drawn into the fire room in the lower portion. The large pressure spike at all three elevations at approximately 10 s post-flashover was a result of wind. The 7 ft pressure increased to greater than 20 Pa, while the 1 ft pressure increased from -10 Pa to 2.5 Pa. The wind sealed off the side B fire room, which prevented fire gases from exhausting and led to an increase in pressure in the fire room because the only remaining exhaust path was the open side C window. Within approximately 5 s, the second side C window failed and the wind speed decreased, leading to a drop in pressure. After the front door was opened, pressures in the fire room increased at all three elevations as the intake vent below the seat of the fire allowed the fire to grow. Following the initial suppression from the top of the stairway and

the flow-and-move toward the fire room, the 4 ft and 7 ft pressures began to decrease and the 1 ft pressure began to increase. As the fire was suppressed, the pressures converged toward ambient.

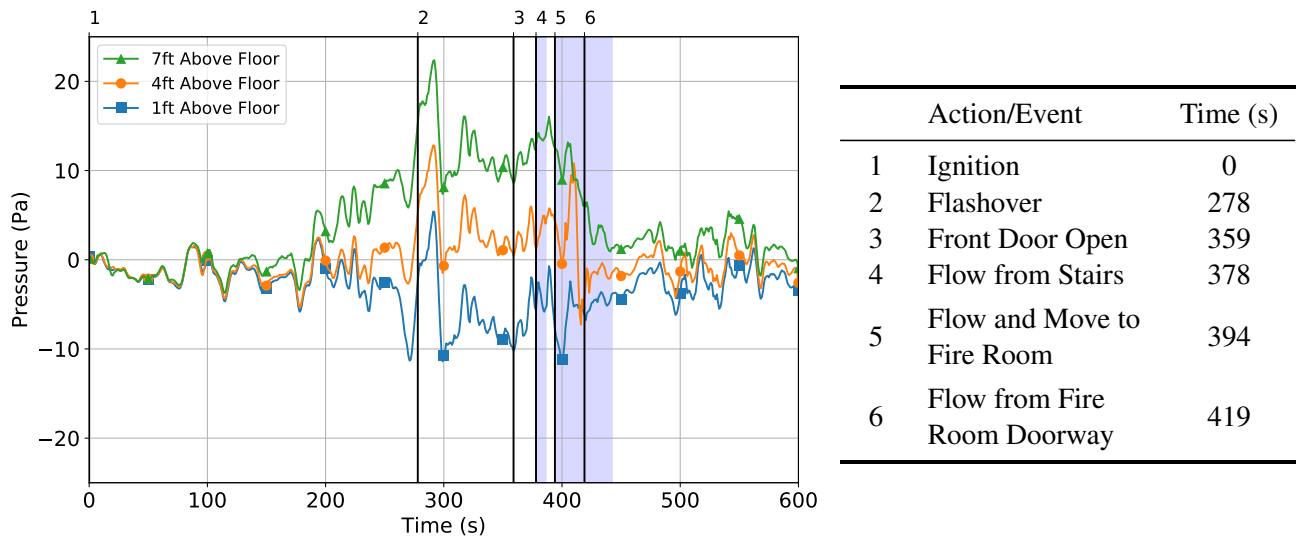
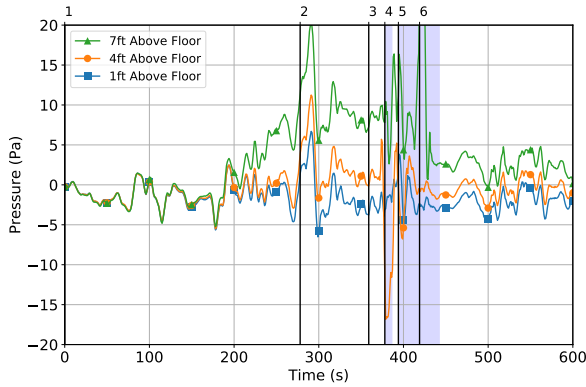
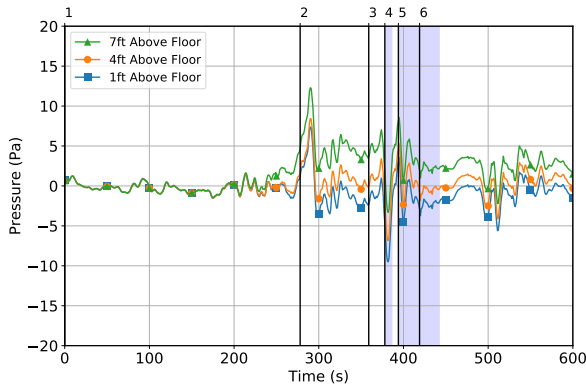

Figure 3.11: Pressures in fire room (bedroom 1) for Experiment 1. Blue vertical bars indicate time and duration of water flow.

The impact of wind was also evident in the pressure measurements from other locations on the second-floor as shown in Figure 3.12. At each location, there was a maximum value at all three elevations that aligned in time with the spike in the fire room pressure, just after flashover as shown in Figure 3.11. The pressure distribution at each location followed a trend similar to the fire room, with the 4 ft and 7 ft pressures that increased as the second-floor filled with products of combustion, and the 1 ft pressure that decreased as air was drawn toward the fire room from remote areas of the structure. As distance from the fire room increased, the magnitude of the 4 ft and 7 ft pressures decreased. Bedroom 3 (see Figure 3.12c) had the lowest pressure rises because it was both the furthest pressure sensor from the fire room and the bedroom door was closed.



(a) Hallway Pressure



(b) Bedroom 2 Pressure

	Action/Event	Time (s)
1	Ignition	0
2	Flashover	278
3	Front Door Open	359
4	Flow from Stairs	378
5	Flow and Move to Fire Room	394
6	Flow from Fire Room Doorway	419

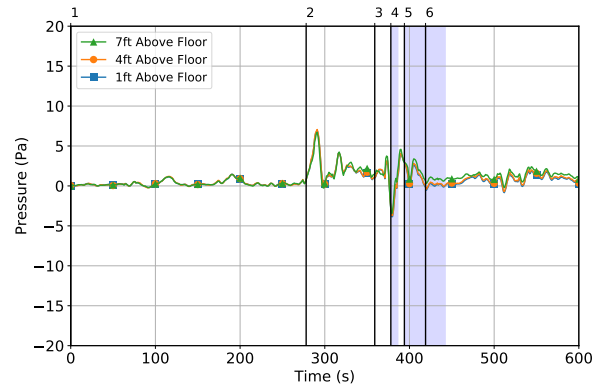

(c) Bedroom 3 Pressure

Figure 3.12: Pressure remote from fire room for Experiment 1. Blue vertical bars indicate time and duration of water flow.

As the fire became ventilation limited, bi-directional flows developed in the fire room windows and fire room doorway, as shown in Figure 3.13a. Hot gases exhausted from the fire room through the top portion of these vents, while cool, fresh air was entrained into the fire room through the lower portion. These flows were maintained until the front door was opened (see Figure 3.13b) which allowed fresh air to flow through the front door, up the stairs, and to the fire room. Since suppression occurred shortly after, no significant fire growth resulted from the additional fresh air.

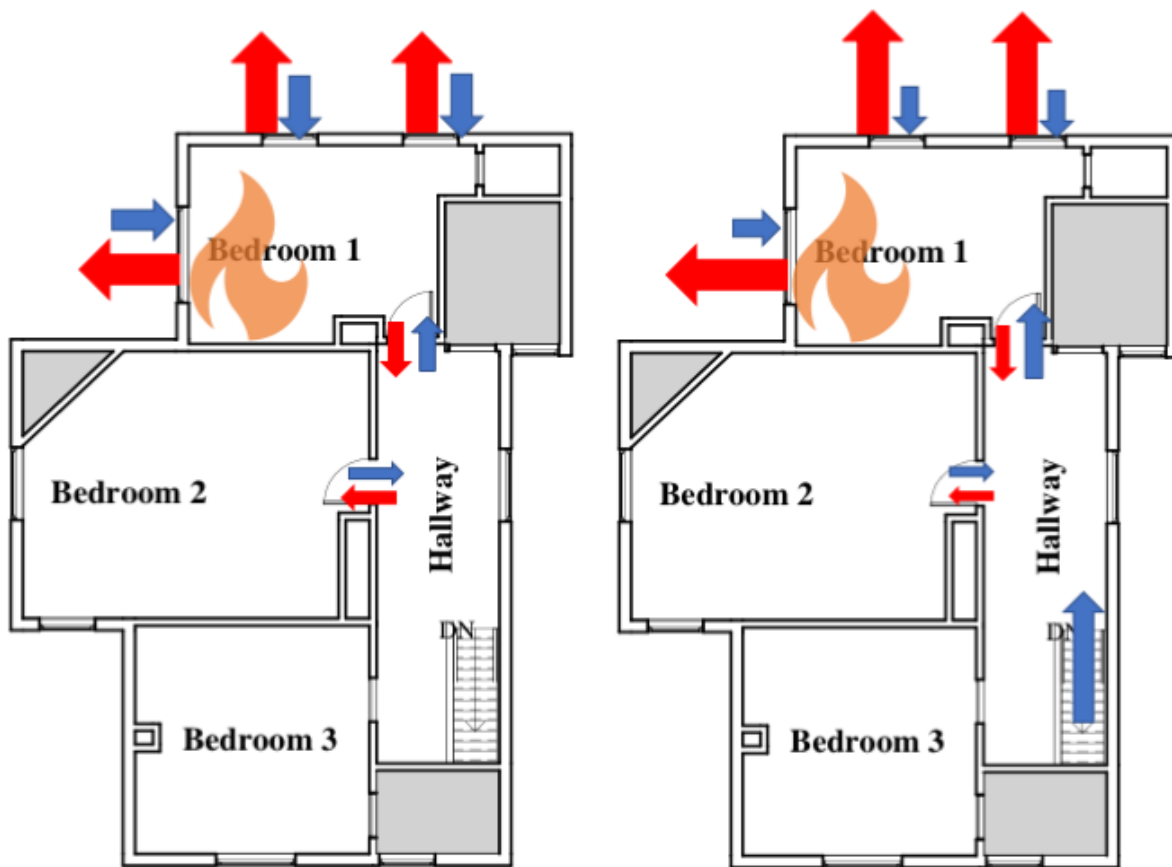

(a) Flows Prior to Front Door Being Opened

(b) Flows After Front Door was Opened

Figure 3.13: Changes in flow during Experiment 1. Red arrows indicate the flow of combustion products, blue arrows indicate the flow of fresh air, and the sizes of the arrows indicate the relative magnitude of the flow through each opening.

Gas concentrations in the hallway (see Figure 3.14a) began to change due to fire growth around 275 s post ignition, approximately the same time that visibility in the hallway decreased. As the front door was opened and the suppression crew entered, the gas concentrations continued to change, reaching a peak hazard corresponding with the initial suppression action in the stairway. As the suppression crew continued flowing water and moving toward the fire room, the 3 ft gas concentrations began to return to pre-ignition concentrations, reflecting the air being entrained along the flow path by the flowing hoseline. Once the hoseline was shut off, the 3 ft O_2 concentration decreased and the 3 ft CO and CO_2 concentrations increased. Following suppression, the lack of pressure generated by the fire combined with wind limited the exiting gases. Instead, those gases flowed through the structure. The 1 ft gas concentration was not as responsive to the changes as the 3 ft gas concentration during the experiment. While the changes in concentrations reflect the increasing hazard associated with fire growth, the muted time response to the increasing and decreasing toxic hazard within the structure indicates there was likely an obstruction on the gas sample line. As a result, the 1 ft elevation concentrations should be examined from a qualitative

and not quantitative perspective.

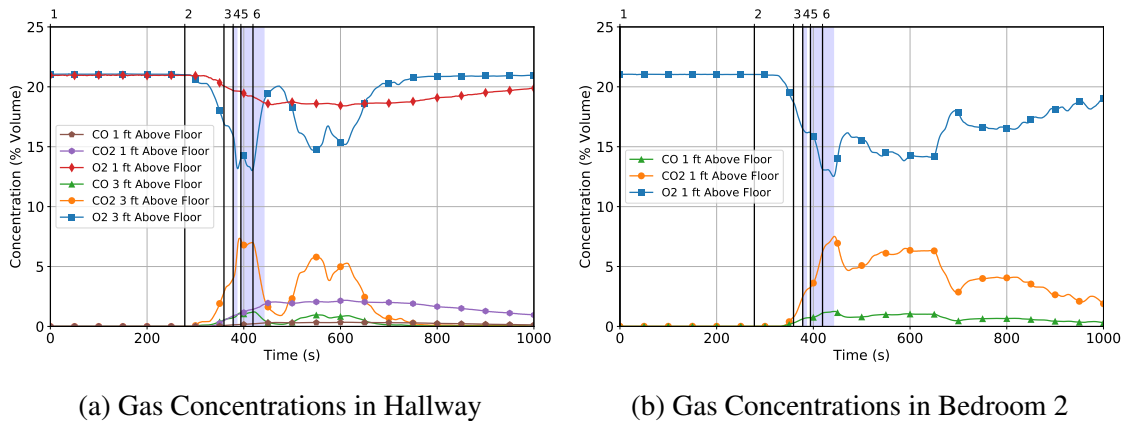

	Action/Event	Time (s)
1	Ignition	0
2	Flashover	278
3	Front Door Open	359
4	Flow from Stairs	378
5	Flow and Move to Fire Room	394
6	Flow from Fire Room Doorway	419

Figure 3.14: Gas concentrations for remote locations in Experiment 1. Blue vertical bars indicate time and duration of water flow.

The gas concentrations in bedroom 2 (see Figure 3.14b) behaved similarly to the hallway location. Gas concentrations in bedroom 2 started to change approximately 300 s post ignition, after visibility was lost in the camera at this location. The peak concentrations occurred as the suppression crew had shut their line down following the hallway suppression action. Gas concentrations then remained relatively steady until there was a gradual recovery toward pre-ignition conditions roughly 650 s post ignition. The gas concentrations remained elevated (low O₂, high CO and CO₂) longer in this location than in the hallway because there was no efficient pathway for the gases to exit the room as it was offset from the flow path that existed between the open front door and open bedroom 1 windows.

3.2 Experiment 2 — Interior Suppression with Hydraulic Ventilation

Experiment 2 was conducted to examine coordinated interior suppression with hydraulic ventilation after knockdown. At 2401 Wapakoneta Avenue in Sidney, Ohio, a two-story, 4,576 sq ft, wood frame structure was instrumented to conduct this second-floor bedroom fire experiment. The four exterior sides of the structure appear in Figure 3.15. The structure was concrete block and brick with stick-built additions using dimensional lumber framing and a combination of brick and vinyl siding. The foundation was a mix of poured concrete, concrete block, and stone. The roof was a combination of a hip-style roof and a peaked roof using 1 in.-by-6 in. sheathing and plywood sheathing covered with asphalt shingles. Detailed dimensioned drawings for the first and second story appear in Appendix Figures B.7 and B.8, respectively.



(a) Side A



(b) Side B



(c) Side C



(d) Side D

Figure 3.15: Exterior photographs of the structure for Experiment 2.

This structure was partitioned into two separate, independent sub-structures. The rooms located along side A of the structure (office, front entry room, and bedrooms 1 and 2) were isolated from the remaining rooms (rear entry room, bedrooms 3 and 4) within the structure. Two independent stairwells allowed this structure to be split so that the interior volume of the structure was similar to that of the other structures examined. The first-floor of the house partitioned for Experiment 2 had an office and front entry room, while the second-floor contained bedroom 1, bedroom 2, and a stairwell landing. These rooms defined the experimental volume, accounting for 1,646 sq ft of the 4,576 sq ft. The structure was instrumented for temperature, pressure, heat flux, IR, and standard video to capture the fire dynamics during experimentation. Instrumentation was also installed to characterize the potential for skin burns and occupant toxic exposure during the experiment. Figure 3.16 shows the layout of the first and second-floors with the instrumentation locations.

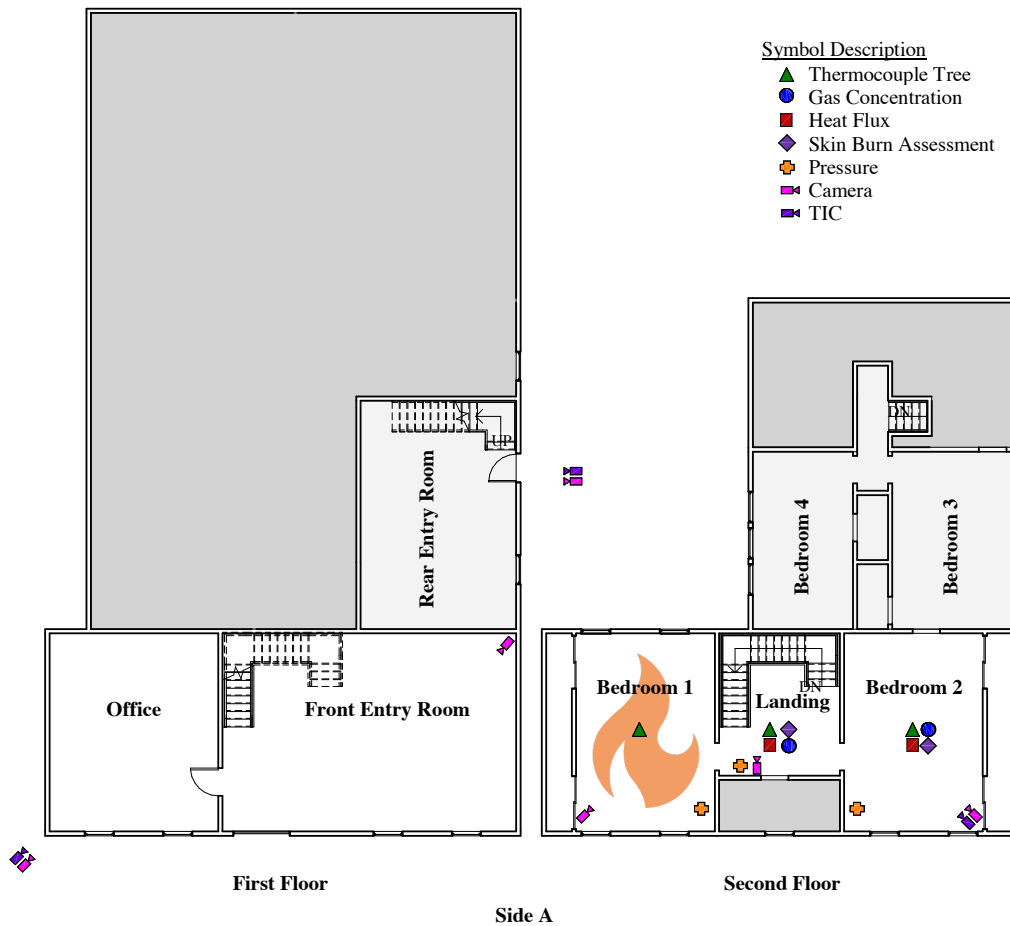

Figure 3.16: Instrumentation and floor plan for Experiment 2. The dark gray areas were isolated from the remainder of the structure and utilized as space for instrumentation. The light gray areas indicate the sub-structure not utilized for this experiment.

Bedroom 1, the fire room for Experiment 2, was furnished with the bedroom fuel package described

in Section 2.4.1. Photographs of the fire room prior to ignition are presented in Figure 3.17. A dimensioned layout of the fire room is included in Figure 3.18.



(a) A/B Corner



(b) B/C Corner



(c) A/D Corner

Figure 3.17: Interior photographs of the fire room for Experiment 2.

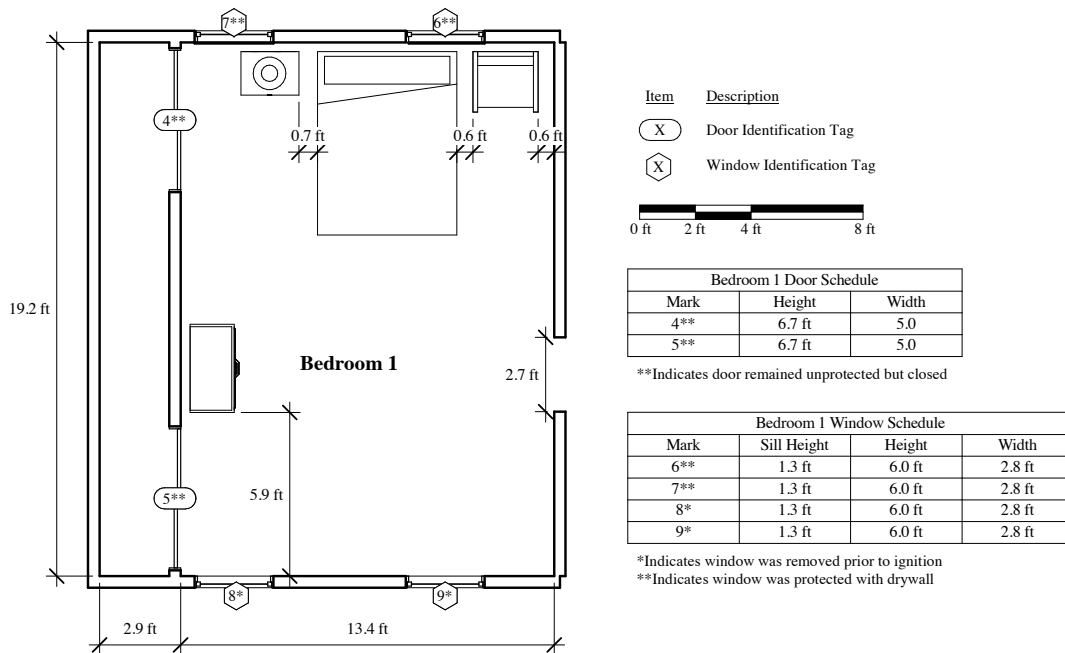

Figure 3.18: Fire room layout for Experiment 2.

To ensure repeatable fire growth and a sufficient oxygen supply for fire growth, the windows labeled 8 and 9 in Figure 3.18 were removed prior to ignition. The windows labeled 6 and 7 in Figure 3.18 were covered with gypsum board for the duration of the experiment as shown in Figure 3.17b. Figure 3.19 shows the sequence of events with an isometric image of the structure.

The fire in Experiment 2 was ignited in the upholstered chair next to the bed ($t = 0$ s). At 252 s (4:12) post ignition, flames were visible out of the open windows. The fire room transitioned to flashover at 278 s (4:38) post ignition. The fire continued to burn with flames extending out of the windows or approximately 3 min., until the initial water was flown by the suppression team.

The first fire department intervention in Experiment 2 was the opening of the front door 421 s (7:01) post ignition. The suppression crew entered the structure and advanced a 1.75 in. hoseline with a combination nozzle set to straight stream toward the second-floor. The first water application occurred from the stairway at 446 s (7:26) post ignition for 8 s in duration. The suppression crew continued to advance toward the fire when the second water application occurred from the landing 463 s (7:43) post ignition for 2 s in duration. The crew entered the fire room to complete suppression 468 s (7:48) post ignition. Three additional water applications occurred; lasting 21 s, 15 s, and 3 s in duration, respectively. After extinguishment, the suppression crew opened their nozzle to fog and began hydraulically ventilating the fire room from the side A window (labeled 9 in Figure 3.18) 610 s (10:10) post ignition. After 40 s, the suppression crew ended hydraulic ventilation at 650 s (10:50) post ignition.

The total tactic time from initial ventilation of the front door to initial suppression was 47 s (00:47). The tactic time from initial ventilation of the front door to the completion of hydraulic ventilation

was 3 min. 49 s (229 s). The total water flowed for initial suppression and hydraulic ventilation was 180 gal, which does not include the additional water used during mop-up operations. Figure 3.19 includes time and sequencing of events along with an isometric image of the structure.

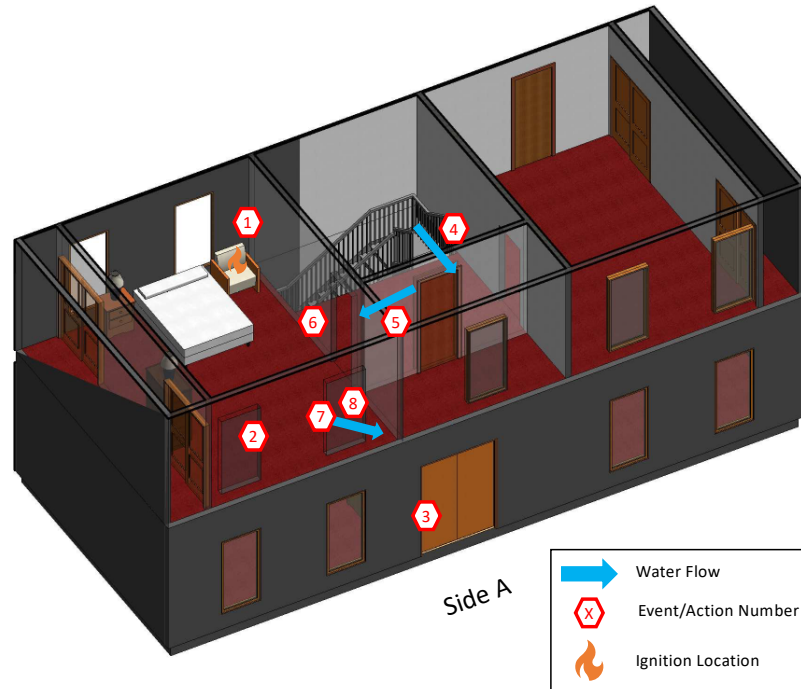

Action/Event	Time (mm:ss)	Time (s)
1 Ignition	00:00	0
2 Flashover	04:38	278
3 Front Door Open	07:01	421
4 Flow from Stairs	07:26	446
5 Flow from Landing	07:43	468
6 Suppression Crew Entered Fire Room	07:48	488
7 Begin Hydraulic Ventilation	10:10	610
8 End Hydraulic Ventilation	10:50	650

Figure 3.19: Time and sequence of actions and events for Experiment 2.

The bare bead thermocouple array located in the fire room was compromised by the stream of the hoseline at an unknown time. The data presented in Figure 3.20 was obtained using an inconel thermocouple array. These thermocouples respond more slowly than bare bead thermocouples; however, this array withstood the hoseline stream. As the fire grew, temperatures close to the ceiling began to increase approximately 70 s post ignition, as shown in Figure 3.20. Temperatures at all elevations began to increase around 200 s post ignition corresponding to the descent of the

smoke layer. Flashover occurred when fire room temperatures increased beyond 1100 °F, 278 s post ignition. Temperatures throughout the room remained steady until interior water flow began. The initial water flow from the stairway was effective at reducing temperatures within the fire room. The subsequent water applications from the landing and fire room doorway further reduced fire room temperatures.

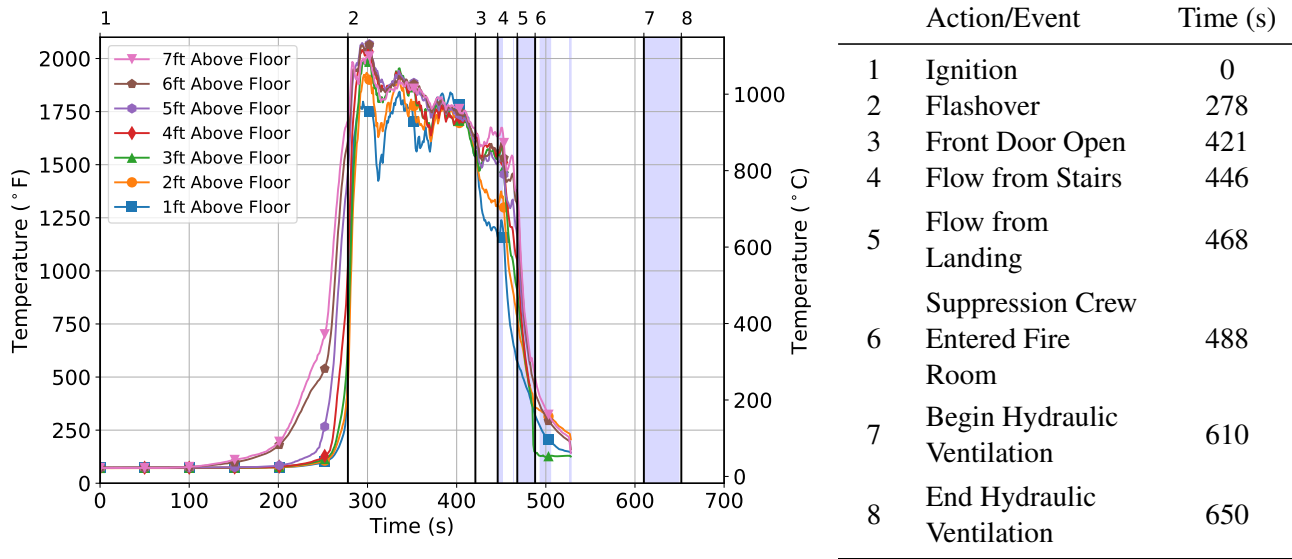
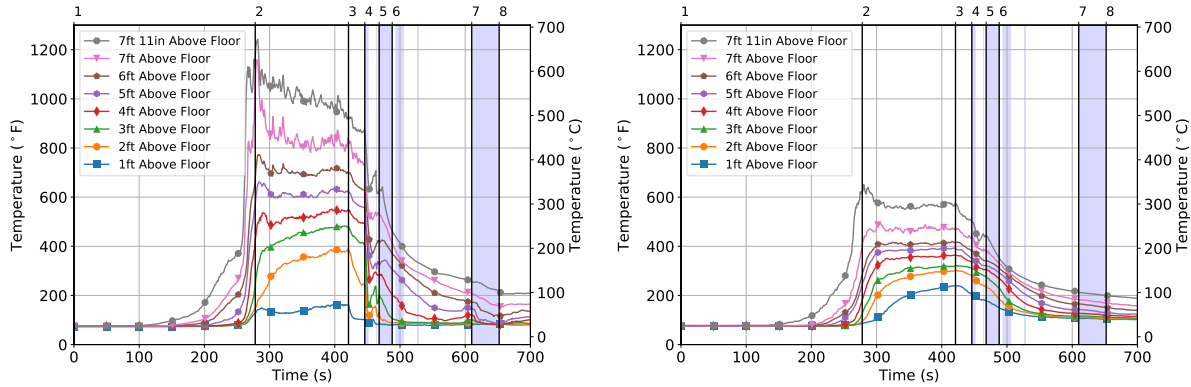

Figure 3.20: Fire room (bedroom 1) temperatures for Experiment 2. Blue vertical bars indicate time and duration of water flow.

The temperatures in the stairway landing (see Figure 3.21a) first started to increase approximately 100 s post ignition (30 s after the fire room temperatures initially rose). As the fire room transitioned through flashover, these temperatures grew to steady values at the time of fire department intervention ranging from 1000 °F at the ceiling to 165 °F 1 ft above the floor. Once the front door was opened, the fresh air entrainment toward the fire room mixed with the gases exiting from the fire room, which caused the landing temperatures at all elevations to decrease. The initial suppression action from the stairway (Action 4) resulted in an immediate but temporary drop in temperatures in the landing. After the water flow from the stairs was stopped, combustion gases flowing from the fire room led to a small increase in landing thermocouple temperatures. The suppression actions in the landing and fire room doorway led to a continued decrease in temperatures. At the time that hydraulic ventilation was initiated, 610 s (10:10) post ignition, the temperatures at all elevations in the landing were less than 250 °F. Hydraulic ventilation had the most profound impact on the 1 ft to 5 ft temperatures, reducing them to near pre-ignition conditions.



(a) Stairway Landing Temperatures

(b) Bedroom 2 Temperatures

Action/Event	Time (s)
1 Ignition	0
2 Flashover	278
3 Front Door Open	421
4 Flow from Stairs	446
5 Flow from Landing	468
6 Suppression Crew Entered Fire Room	488
7 Begin Hydraulic Ventilation	610
8 End Hydraulic Ventilation	650

Figure 3.21: Stairway landing and bedroom 2 temperatures for Experiment 2. Blue vertical bars indicate time and duration of water flow.

As bedroom 2 was farther from the fire room than the stairwell landing, the measured temperatures in bedroom 2 were less (see Figure 3.21b). Bedroom 2 temperatures followed a similar trend to those at the landing. At the time of fire department intervention, most of the temperatures in bedroom 2 had reached a steady state, ranging from approximately 550 °F at the ceiling to 250 °F 1 ft above the floor. Once the front door was opened, the temperature at all elevations decreased. The temperatures in bedroom 2 were not as responsive to the actions of the suppression crew. The temperatures began to decrease more quickly as suppression actions progressed into the fire compartment. The temperatures at all elevations in bedroom 2 had decreased below 215 °F at the time that hydraulic ventilation was initiated. Hydraulic ventilation did not have any noticeable impact on the temperatures in bedroom 2 as bedroom 2 was not in the flow path.

The heat flux time histories (see Figure 3.22) at 1 ft and 3 ft above the floor in the stairway landing and 1 ft above the floor in bedroom 2 followed a trend similar to the temperature profiles at these locations. The heat flux at both elevations in the stairway landing began to increase approximately 250 s post ignition, as the smoke layer began to descend to the floor. At approximately the time of flashover, the 3 ft heat flux reached a local peak of approximately 4 kW/m² and maintained this heat flux until the front door was opened. The 1 ft heat flux reached a greater peak heat flux of 10 kW/m² shortly after flashover, before decreasing below 1 kW/m² at the time the front door was opened. The greater heat flux at the 1 ft level following flashover was likely due to the 3 ft

gauge being completely covered by the smoke layer. The 1 ft gauge, however, remained below the smoke layer and had a line of sight to the flames at the doorway of the fire room. The heat flux at the 1 ft level decreased as the smoke layer continued to descend and there was less combustion at the fire room doorway. Most of the burning in the fire room was located near the window vents. After the front door was opened, the 3 ft landing heat flux began to decrease and the 1 ft landing heat flux remained steady. Suppression in the landing (Action 5) further decreased the landing heat flux, and as suppression continued in the fire room doorway (Action 6), the heat fluxes decreased to approximately pre-ignition conditions. The heat flux 1 ft above the floor in bedroom 2 was considerably less than the stairway landing, remaining below 2 kW/m^2 for the duration of the experiment.

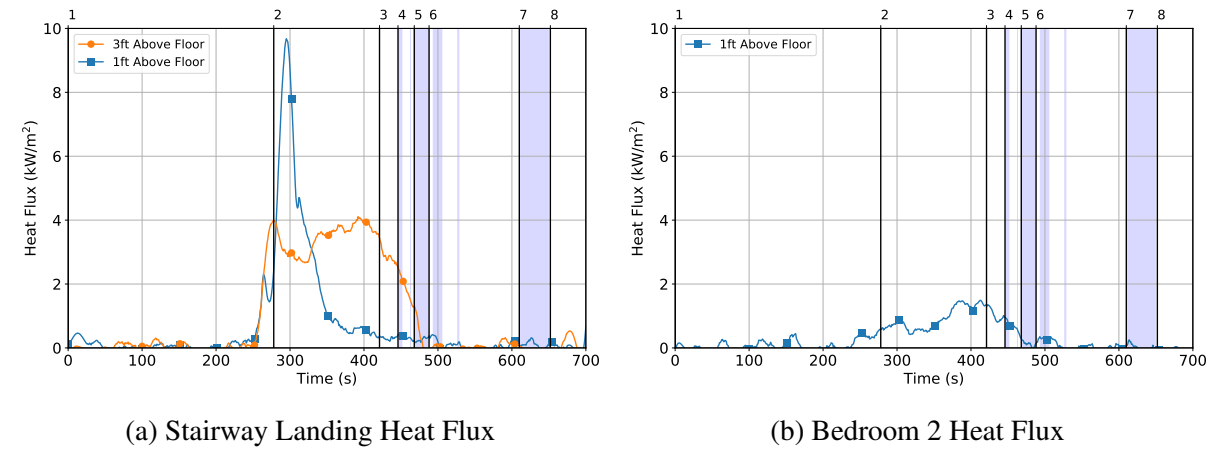

Action/Event	Time (s)
1 Ignition	0
2 Flashover	278
3 Front Door Open	421
4 Flow from Stairs	446
5 Flow from Landing	468
6 Suppression Crew Entered Fire Room	488
7 Begin Hydraulic Ventilation	610
8 End Hydraulic Ventilation	650

Figure 3.22: Heat flux at remote locations for Experiment 2. Blue vertical bars indicate time and duration of water flow.

The pressures in the fire room, stairway landing, and bedroom 2 can be used to understand the growth of the fire and the subsequent flow of hot gases throughout the second-floor. Figure 3.23 shows the pressure time histories for these three locations on the second-floor. The pressure 7 ft above the floor in the fire room (see Figure 3.23a) first started to increase approximately 125 s post ignition, indicating hot gases were starting to accumulate close to the ceiling in the fire room. As the smoke layer continued to descend, 250 s post ignition, the 4 ft pressure began to increase and the 1 ft pressure began to decrease. The decrease at the lowest pressure sensor indicated the fire entrained air and therefore created a local area of low-pressure. Shortly afterward, the room

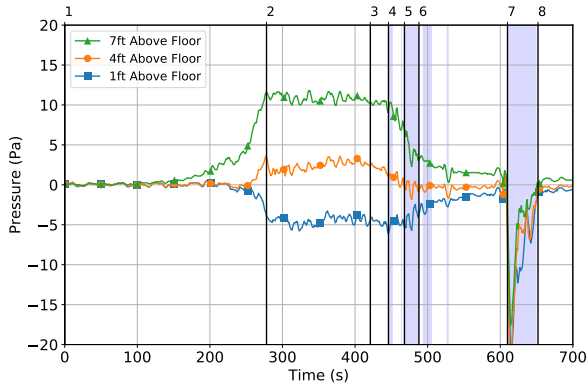

(a) Bedroom 1 Pressure

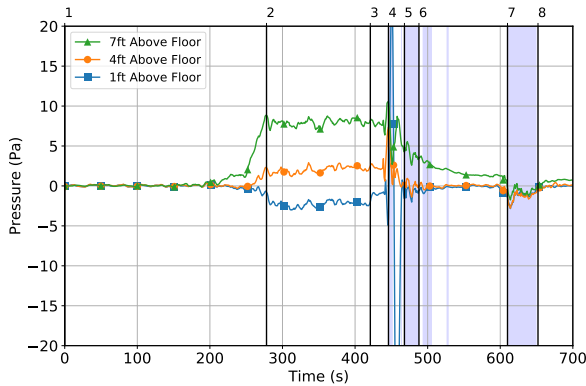

(b) Stairway Landing Pressure

Action/Event	Time (s)
1 Ignition	0
2 Flashover	278
3 Front Door Open	421
4 Flow from Stairs	446
5 Flow from Landing	468
6 Suppression Crew Entered Fire Room	488
7 Begin Hydraulic Ventilation	610
8 End Hydraulic Ventilation	650

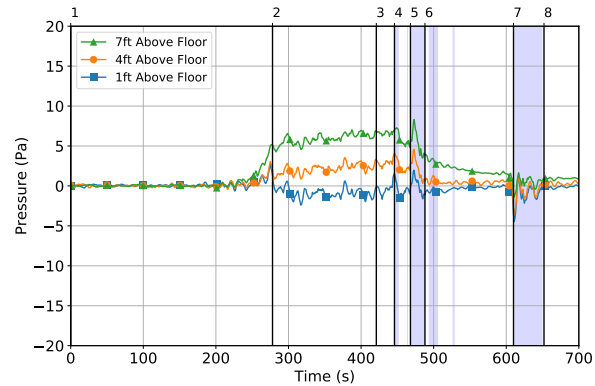

(c) Bedroom 2 Pressure

Figure 3.23: Second-floor pressure for Experiment 2. Blue vertical bars indicate time and duration of water flow.

transitioned through flashover. In the post-flashover period prior to fire department intervention, the fire room pressures were maintained at 10 Pa, 2.5 Pa, and -5 Pa relative to ambient at the 7 ft, 4 ft, and 1 ft elevations, respectively. The fire room pressures began to decrease after the initial stairway suppression (Action 4), indicating temperatures in the fire room dropped and gases began to contract. As the suppression crew advanced toward the fire room and continued suppression from the fire room doorway, the relative pressures in the fire room continued to converge to ambient pressure.

The pressures in the stairway landing (see Figure 3.23b) and bedroom 2 (see Figure 3.23c) followed a similar trend in the period prior to the front door opening, although the magnitudes of the pressures were less than in the fire room. This indicates hot gases were flowing from the fire room to remote areas of the second-floor while at the same time fresh air was being entrained into the fire room from these remote rooms. Following the front door opening, the 1 ft pressure in the stairway landing increased in magnitude, indicating more air was being drawn into the fire room from the exterior of the structure because this pressure was in the flow path between the front door intake and fire room exhaust. Additionally, water flow from the stairs (Action 4) led to a drop in pressure at the 1 ft level before recovering as firefighters entered the fire room (Action 5). Similar to the

fire room pressures, the pressures in the stairwell and bedroom 2 converged to ambient following suppression in the fire room.

When hydraulic ventilation was initiated 610 s (10:10) post ignition, the pressure decreased by 15 Pa in the fire room. Note: That at its peak, the fire generated approximately 10 Pa of overpressure in the fire room. By the time the nozzle was closed 40 s after it was opened, the pressures in the fire room had returned to approximately ambient. Similar drops in pressure were observed in the stairwell landing and bedroom 2, but these pressure decreases were significantly smaller. In the landing, the pressure decreased by 2.5 Pa at all three elevations, and fluctuated between positive and negative pressures for the duration of the hydraulic ventilation. In bedroom 2, the pressure also decreased but fluctuated for the duration of the tactic.

The changes in flow during the experiment are illustrated in Figure 3.24. As the fire grew to a point where it became ventilation limited, bi-directional flows existed at the fire room windows. Fresh air was entrained into the fire room through the lower portion of the window, and hot gases were exhausted out of the top of fire room windows. Additionally, fresh air was drawn through the bottom of the fire room doorway from the remainder of the experimental volume as combustion gases flowed out of the top of the doorway, as shown in Figure 3.24a. The opening of the front door created another intake vent; fresh air flowed into the structure through the front door and traveled up the stairs and into the fire room, while hot gases exhausted from the upper portion of the fire room windows and doorway, as shown in Figure 3.24b. After the suppression team brought the fire under control, hydraulic ventilation was initiated as shown in Figure 3.24c. The window was turned into a low-pressure vent, allowing products of combustion to be exhausted from the structure.

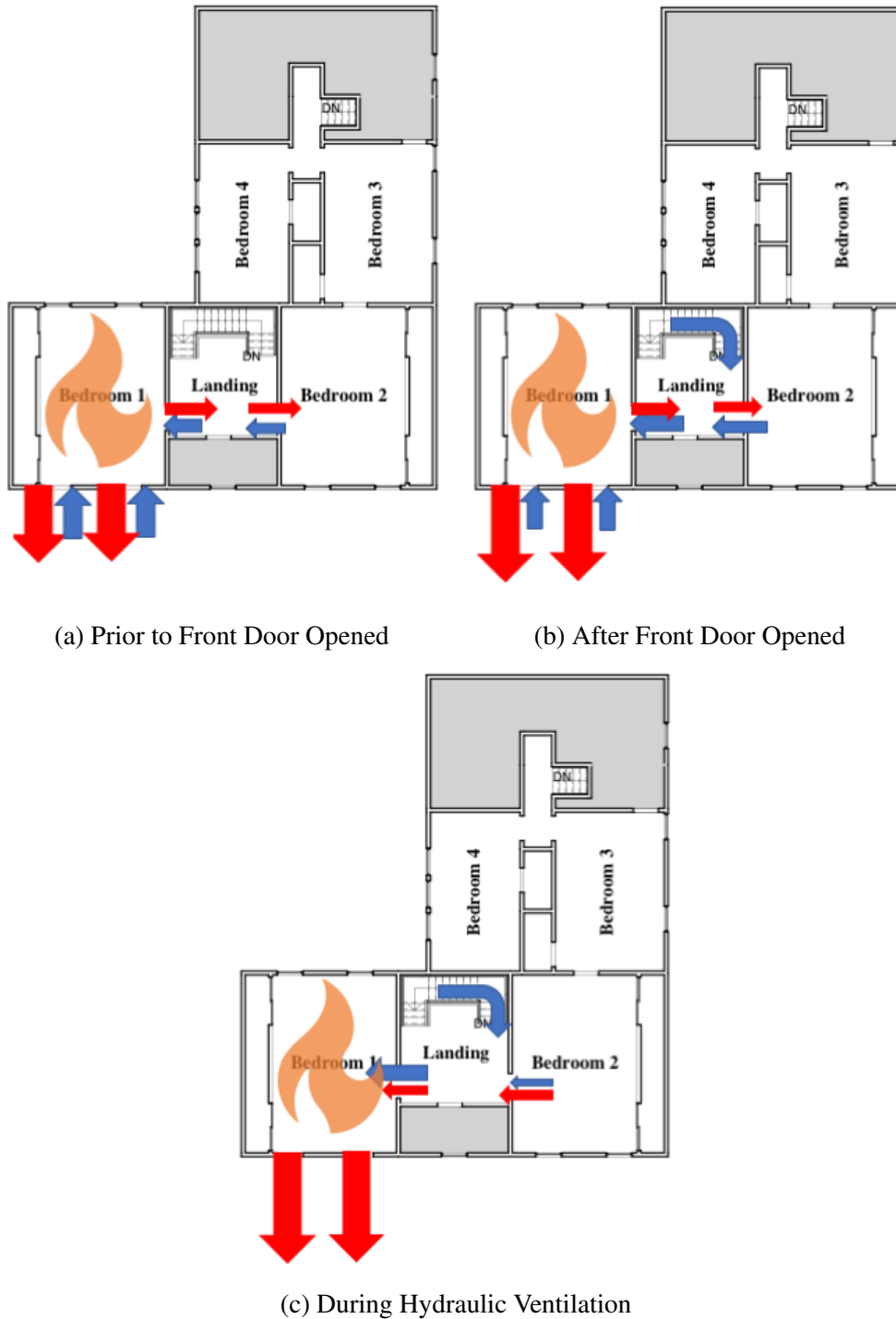
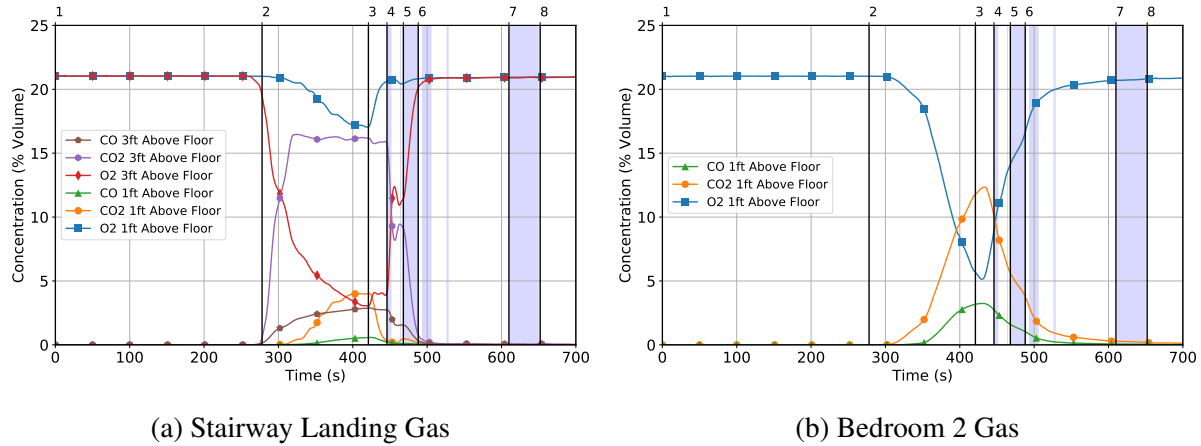

Figure 3.24: Changes in flow during Experiment 2. Red arrows indicate the flow of combustion products, blue arrows indicate the flow of fresh air, and the sizes of the arrows indicate the relative magnitude of the flow through each opening.

The changes in pressure provided the driving force for the variations in gas concentrations at the 1 ft and 3 ft elevation in the stairway landing and 1 ft elevation in bedroom 2 as shown in Figure 3.25.

In the stairway, the O₂ concentrations began to decrease and the CO and CO₂ concentrations began to increase at both elevations shortly before flashover. At the 3 ft elevation (see Figure 3.25a) on the landing when the front door was opened, the O₂, CO₂, and CO concentrations were 3.0%, 16.0%, and 3.0%, respectively. The opening of the front door resulted in a minimal increase in O₂ and decrease in CO, but the gas concentrations did not begin to significantly change until after the initial water application from the stairway. After water flow was stopped, there was a fluctuation in gas concentrations before the suppression action from the stairway landing, when the gas concentrations permanently began to return to pre-ignition conditions.



Action/Event	Time (s)	
1	Ignition	0
2	Flashover	278
3	Front Door Open	421
4	Flow from Stairs	446
5	Flow from Landing	468
6	Suppression Crew Entered Fire Room	488
7	Begin Hydraulic Ventilation	610
8	End Hydraulic Ventilation	650

Figure 3.25: Gas concentrations at 1 ft and 3 ft in stairway landing and in bedroom 2 for Experiment 2. Blue vertical bars indicate time and duration of water flow.

The gas concentrations at the 1 ft level in the stairway (see Figure 3.25a) were typically less hazardous than the corresponding 3 ft gas concentrations. The 1 ft gas concentrations in the stairway landing first began to increase as the fire room transitioned through flashover. The peak gas concentrations were measured immediately before the front door was opened, and were 17.0%, 4.0%, and 1.0% for O₂, CO₂, and CO respectively. The fresh air entrained by the opening of the front door immediately resulted in an increase in O₂ and decrease in CO₂ and CO. A change in concentration was observed after the initial suppression action (Action 4) from the stairway that was caused by either pressure-driven flow from the nozzle or from mixing and cooling of the upper gas layer. The gas concentrations at the 1 ft level had returned approximately to pre-ignition conditions by the time that the suppression crew entered the fire room (Action 6). The CO concentration decreased

below 0.1% 55 s after the front door was opened. It should be noted that the gas concentrations at both locations in the stairway landing returned to pre-ignition conditions rather quickly after the onset of suppression actions and therefore were largely unaffected by the subsequent hydraulic ventilation.

The gas concentrations in bedroom 2 (see Figure 3.25b) first started to increase approximately 300 s post ignition. At the time the front door was opened, the O₂ was approximately 5.0% and the CO and CO₂ were 4.0% and 13%, respectively. The gas concentrations reached a peak approximately 5 s after the front door was opened and subsequently began to return to pre-ignition conditions. The gas concentrations in bedroom 2 took longer to recover than the corresponding location in the stairway because this location was impacted by being at the dead end of the structure—there was little to no inlet flow that could bring fresh air through the compartment and assist in moving combustion gasses out.

3.3 Experiment 3 — Interior Suppression Followed By Vertical Ventilation

Experiment 3 was conducted to examine coordinated interior suppression and vertical ventilation. At 1492 Dayton Xenia Road in Xenia, Ohio, a two-story, 2,100 sq ft, wood frame structure was instrumented to conduct this second-floor bedroom fire experiment. The four exterior sides of the structure appear in Figure 3.26. The structure was stick-built with rough cut lumber framing with wood-slat siding. The foundation was a mix of concrete block and stone. The hip-style roof was constructed using 1 in.-by-6 in. sheathing covered with asphalt shingles. Detailed dimensioned drawings for the first and second story appear in Appendix Figures B.14 and B.15, respectively.



Figure 3.26: Exterior photographs of the structure for Experiment 3.

The first-floor of the structure had an entryway, living room, dining room, kitchen, and stairway. The second-floor had three bedrooms and a hallway that connects the three to the stairwell. These areas defined the experimental volume of the structure. The structure was instrumented for temperature, pressure, heat flux, IR, and standard video to capture the fire dynamics during experimentation. Instrumentation was also installed to characterize the potential for skin burns and occupant

toxic exposure during the experiment. Figure 3.27 shows the layout of the first and second-floors with the instrumentation locations.

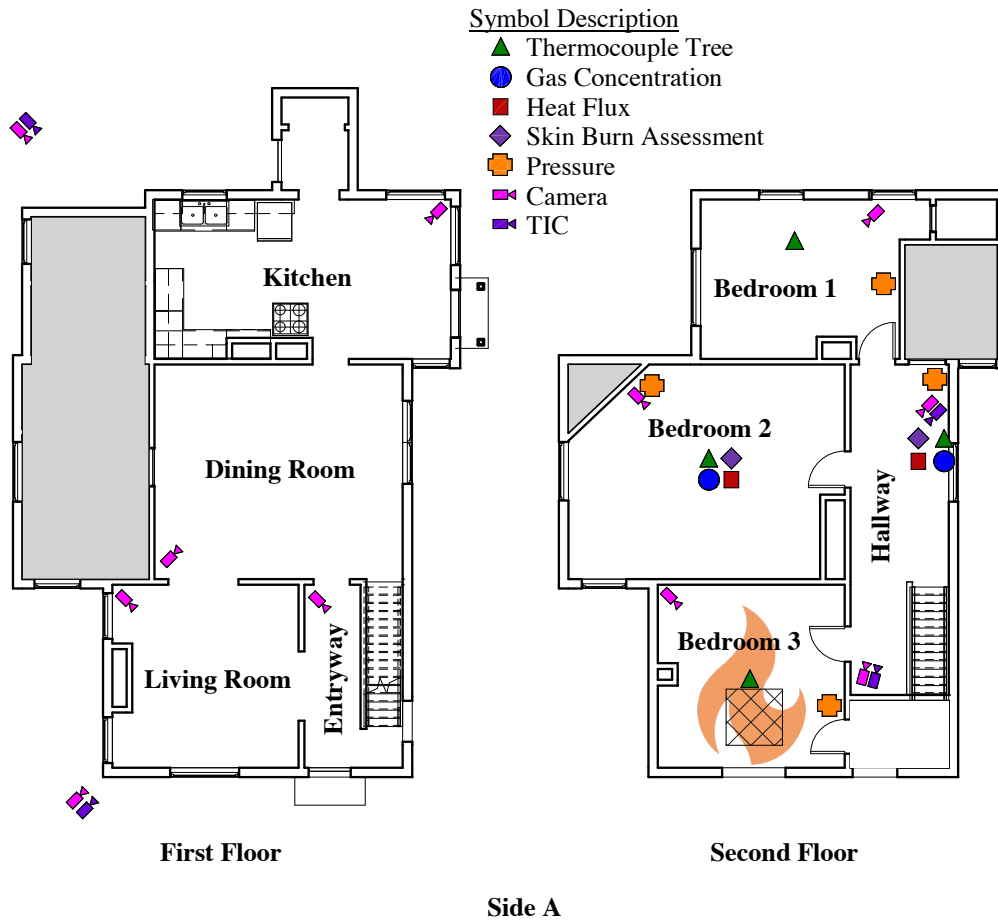

Figure 3.27: Instrumentation and floor plan for Experiment 3. The gray areas were isolated from the remainder of the structure and utilized as space for instrumentation. The cross-hatched box indicates the size and location of the vertical vent.

Bedroom 3, the fire room, was furnished with the bedroom fuel package described in Section 2.4.1. Photographs of bedroom 3 prior to ignition are presented in Figure 3.28. A dimensioned layout of the fire room is included in Figure 3.29.



Figure 3.28: Interior photographs of fire room for Experiment 3.

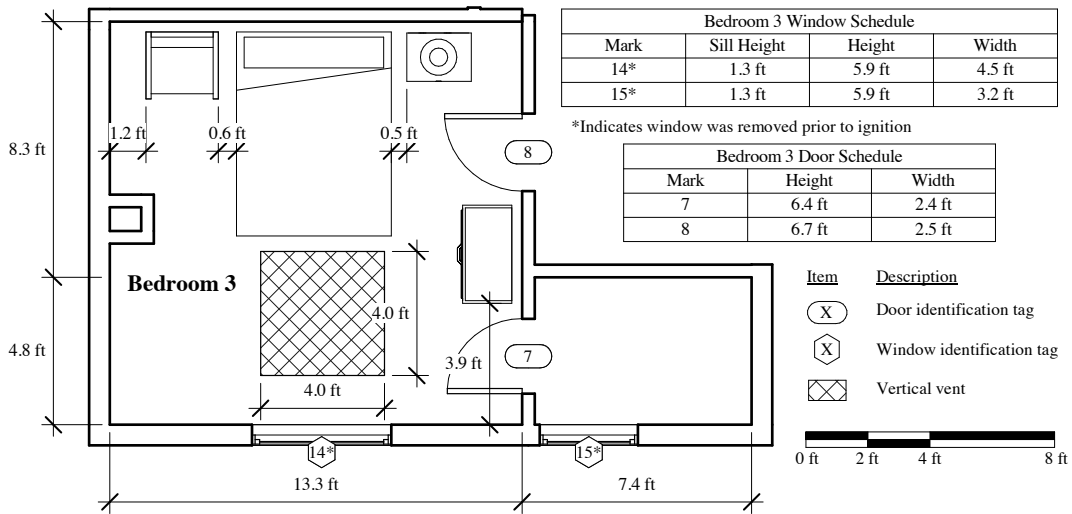

Figure 3.29: Fire room layout for Experiment 2. The cross-hatched box indicates the size and location of the vertical vent.

Experiment 3 examined a coordinated interior suppression with vertical ventilation post knock-down. Prior to ignition, a 4 ft-by-4 ft roof hole and ceiling hole located over bedroom 3 were cut. The roof hole was covered by plywood and sealed to prevent leakage. The ceiling hole was covered with half-inch gypsum board. Ventilation occurred by first removing the plywood to expose the precut roof hole, replicating a crew cutting a ventilation hole. Immediately following, the interior gypsum was released to expose the precut ceiling hole, replicating a crew removing the compartment ceiling materials. Figure 3.30 shows the interior hinged ceiling.

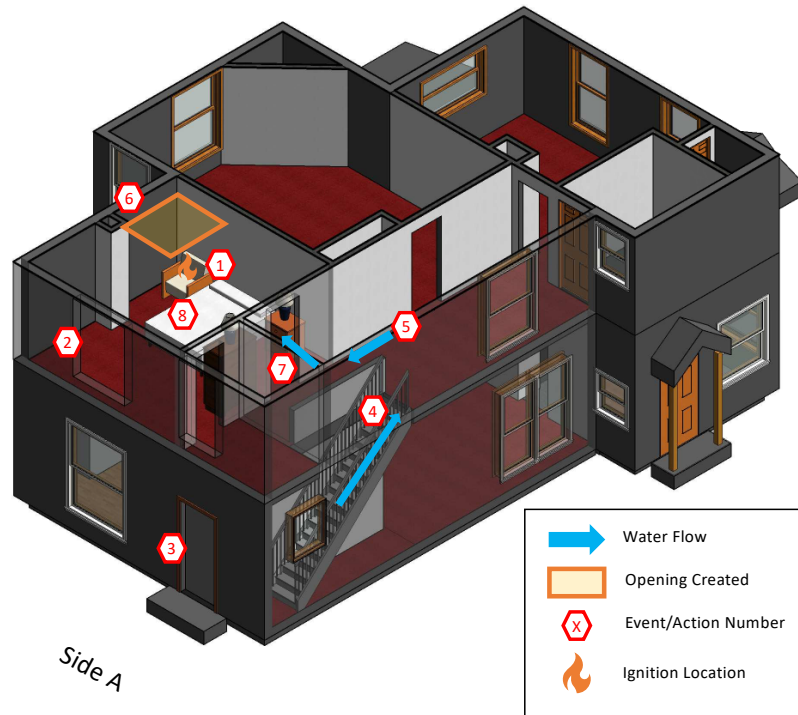

Figure 3.30: Interior vertical ventilation opening for Experiment 3.

To ensure repeatable fire growth and a sufficient oxygen supply for flashover, the windows labeled 14 and 15 in Figure 3.29 were removed prior to ignition.

The fire was ignited in the upholstered chair next to the bed set ($t = 0$ s). Flames were first visible from the side A windows at 240 s (4:00) post ignition. Flames continuously vented from the side A windows at 249 s (4:09) post ignition. The fire grew and reached flashover at 257 s (4:17) post ignition. The fire transitioned to a post-flashover state before the first fire department intervention.

The sequence of fire department interventions started with the opening of the front door at 330 s (5:30) post ignition. The suppression crew entered 10 s (5:40) later and advanced halfway up the stairwell. Using a 1.75 in. hoseline with a combination nozzle set to straight stream, the crew applied water in the direction of the fire room at 351 s (5:51) post ignition for 7 s. They then advanced to the top of the stairs and continued suppression from the fire room doorway landing 376 s (6:16) post ignition for 10 s. The suppression crew paused in the hallway while the vertical ventilation hole was opened and the ceiling was pushed in, completing the vertical vent at 411 s (6:51). The suppression crew then began to flow water from the fire room doorway at 422 s (7:02) post ignition for 6 s. The crew entered the fire room 432 s (7:12) post ignition before flowing water for an additional 14 s. The total time from the initial action of opening the front door to occupying the fire room was 81 s (1:21). The total water used for initial suppression was 88 gal, which does not include the additional water used during mop-up operations. Figure 3.31 shows the sequence of events with an isometric image of the structure.



Action/Event	Time (mm:ss)	Time (s)
1 Ignition	00:00	0
2 Flashover	04:17	257
3 Front Door Open	05:30	330
4 Flow from Stairs	05:51	351
5 Flow from Landing	06:17	376
6 Vertical Ventilation Completed	06:51	411
7 Flow from Fire Room Doorway	07:02	422
8 Suppression Crew Entered Fire Room	07:12	432

Figure 3.31: Time and sequence of actions and events for Experiment 3.

As the fire in bedroom 3 grew, the temperatures close to the ceiling began to rise; the 7 ft 11 in. temperature began to increase approximately 50 s post ignition. The fire transitioned through flashover 257 s following ignition (Event 2). The fire remained in a post-flashover state until the initial suppression action from the stairway (Action 4), which was effective in reducing temperatures in the fire room. Temperatures further decreased in the fire room with the second water application from the stairway landing. The suppression actions from the stairway and landing reduced temperatures to below 700 °F at all elevations in the fire room until suppression was halted to complete vertical ventilation. The temperatures in the fire room gradually increased during this period, indicating the suppression actions were effective but did not completely extinguish the fire. Once the vertical

ventilation was completed (Action 6), temperatures continued to increase at the same rate prior to ventilation. The lack of a significant increase in temperature suggests that vertical ventilation did not cause an increase in fire size. It is important to recognize that in this scenario, vertical ventilation was completed after the initial suppression action on the fire. The final suppression actions from the fire room doorway and inside the fire room returned conditions toward pre-ignition conditions.

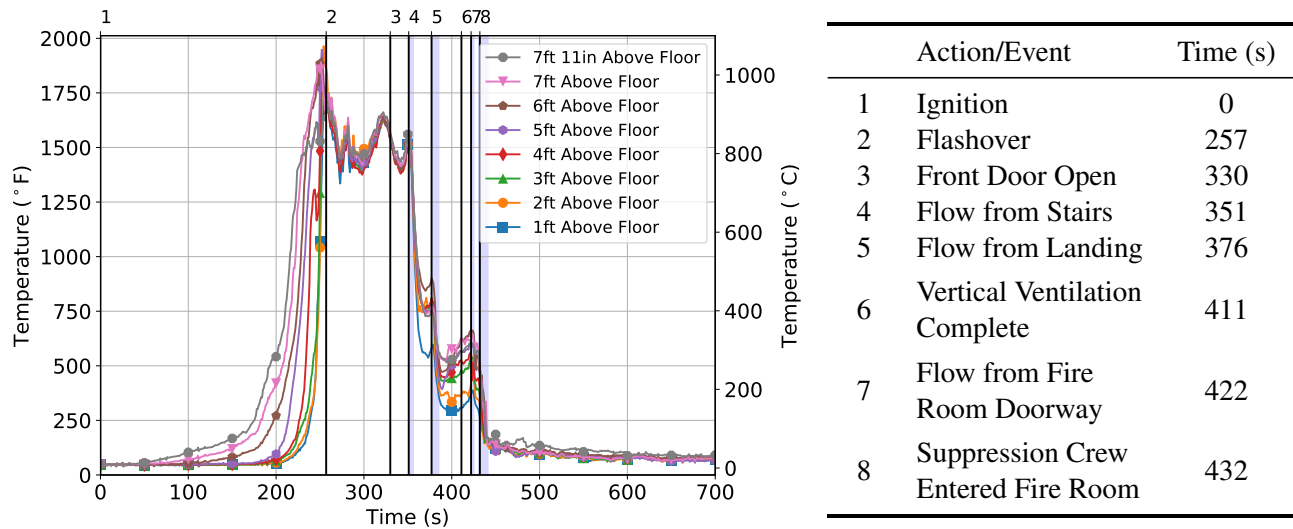
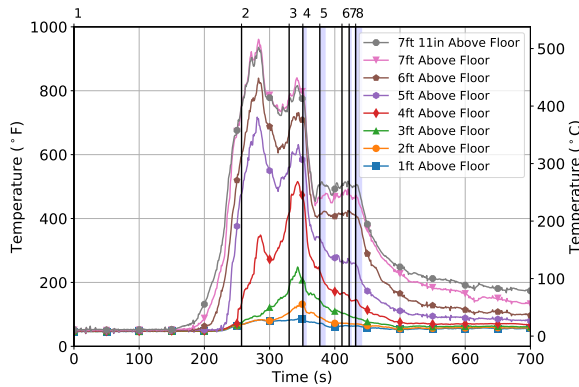

Figure 3.32: Fire room (bedroom 3) temperatures for Experiment 3. Blue vertical bars indicate time and duration of water flow.

The highest temperatures measured in remote areas of the second-floor were in the hallway, the space adjacent to the fire room. Temperatures close to the ceiling in the hallway first began to increase approximately 150 s post ignition, and began to increase more rapidly as the fire room transitioned through flashover, as shown in Figure 3.33a. A local peak was observed at the 4 ft through 7 ft 11 in. heights approximately 245 s post ignition, which appeared to correspond with a gust of wind. At the time the front door was opened, the temperatures 5 ft and above in the hallway were approximately steady, while those closer to the floor were increasing. The initial suppression action in the stairway (Action 4) decreased the temperatures close to the ceiling by 450 °F. After the initial suppression from the stairway, the temperatures 4 ft and below never exceeded 300 °F for the remainder of the experiment. The temperatures between 6 ft above the floor and the ceiling remained steady above 400 °F in the period between the stairway and landing area suppression actions (Actions 4 and 5). There was no significant increase in temperature in the hallway following the completion of the vertical vent. As the suppression crew continued final suppression from the fire room doorway and inside the fire room itself, temperatures at all elevations in the hallway decreased permanently. 600 s post ignition (270 s after front door open), the ceiling temperature dropped below 200 °F.



(a) Hallway Temperatures

Action/Event	Time (s)
1 Ignition	0
2 Flashover	257
3 Front Door Open	330
4 Flow from Stairs	351
5 Flow from Landing	376
6 Vertical Ventilation Completed	411
7 Flow from Fire Room Doorway	422
8 Suppression Crew Entered Fire Room	432

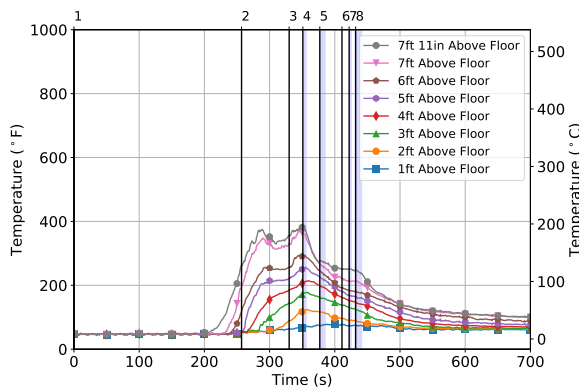

(b) Bedroom 2 Temperatures

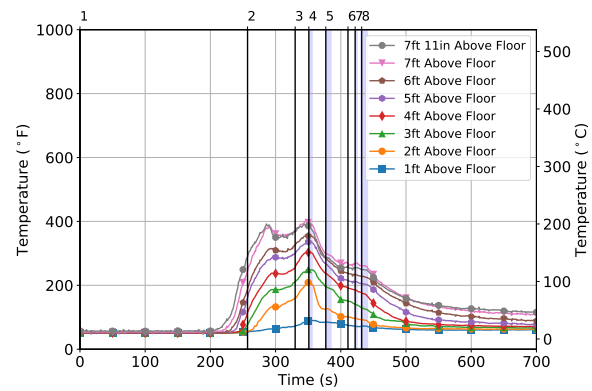

(c) Bedroom 1 Temperatures

Figure 3.33: Second-floor temperatures for Experiment 3. Blue vertical bars indicate time and duration of water flow.

The temperatures in the remote bedrooms (bedrooms 1 and 2) were less than those observed in the hallway. In both of the remote rooms, temperatures began to increase approximately 200 s post ignition. The peak temperatures close to the ceiling were approximately 400 °F. The temperatures in each of the remote rooms were still increasing at the time the front door was opened. The initial suppression from the stairway caused temperatures to decrease at all elevations in both bedrooms. Similar to the temperatures in the hallway, the temperatures in the remote bedrooms remained approximately steady in the period between the landing suppression action (Action 5) and the completion of the vertical vent (Action 6). Temperatures in the remote rooms continued to decrease after the final suppression actions following vertical ventilation.

Heat flux as shown in Figure 3.34 was measured 1 ft and 3 ft above the floor in the hallway and 1 ft above the floor in bedroom 2. The heat flux at both 1 ft locations was less than 1 kW/m² for the duration of the experiment. The 3 ft heat flux recorded notably greater peaks, and first started to increase approximately 200 s post ignition. A local peak in heat flux was observed at approximately 285 s post ignition, at a similar time that local temperature peaks were observed. The maximum heat flux observed during the experiments was 9 kW/m², and was measured at the time the front door was opened. The heat flux decreased significantly with the opening of the front door and the initial suppression action from the stairway (Action 2). After this initial suppression, the heat flux remained below 2 kW/m² for the remainder of the experiment.

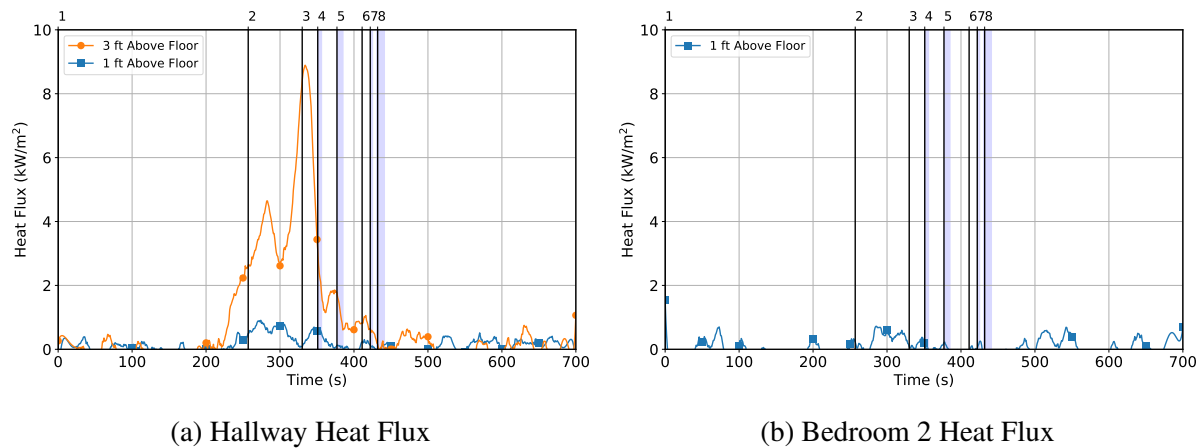

	Action/Event	Time (s)
1	Ignition	0
2	Flashover	257
3	Front Door Open	330
4	Flow from Stairs	351
5	Flow from Landing	376
6	Vertical Ventilation Completed	411
7	Flow from Fire Room Doorway	422
8	Suppression Crew Entered Fire Room	432

Figure 3.34: Heat flux at remote locations for Experiment 3. Blue vertical bars indicate time and duration of water flow.

The pressures in the fire room, shown in Figure 3.35, reflect the growth of the fire and the changes in flow during the experiment. As the fire grew, the 7 ft and 4 ft pressures began to increase above 0 Pa, while the 1 ft pressure decreased below 0 Pa. This indicates the upper portion of the fire room was filled with products of combustion and was acting as an exhaust while fresh air was being entrained into the fire room at the 1 ft level. This profile was maintained while the fire was burning in a post-flashover state. There was a brief fluctuation in the fire room pressures from a wind gust, which occurred 285 s post ignition. This was also seen in the temperature and heat flux data. Once the front door was opened, the pressure at all three elevations in the fire room decreased. The magnitude of the pressure at all three elevations continued to decrease as suppression occurred from the stairway and landing, and even further as vertical ventilation was completed. Following vertical ventilation, pressures continued to converge to ambient as final suppression occurred.

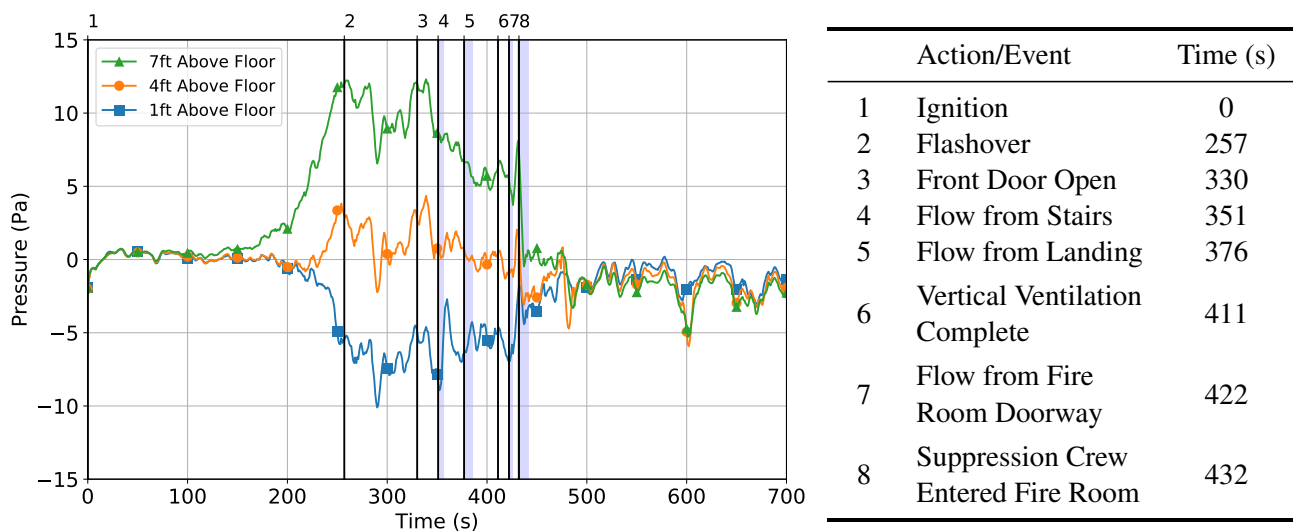
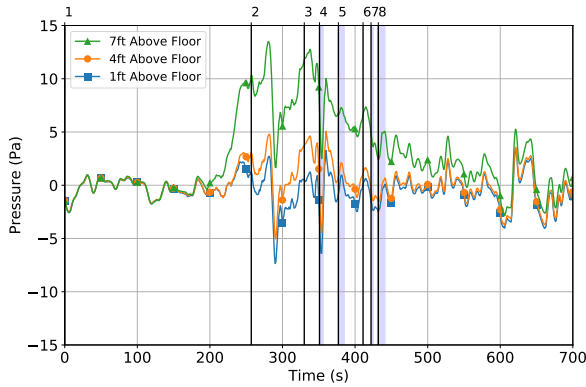

Figure 3.35: Pressures in fire room (bedroom 3) for Experiment 3. Blue vertical bars indicate time and duration of water flow.

The pressure changes as a result of fire growth and wind were also reflected in the pressures in remote areas of the structure, which are displayed in Figure 3.36. The pressures in the hallway and bedrooms 1 and 2 first began to change between 200 s and 225 s post ignition. At the time the front door was opened, the pressures at all three elevations in the three locations were positive, with the highest pressures measured closest to the ceiling. This indicates that at the time of fire department intervention, air was being entrained into the fire room from remote areas of the second-floor. Both the opening of the front door and the completion of the vertical vent hole resulted in a decrease in pressures throughout the second-floor.



(a) Hallway Pressure

Action/Event	Time (s)
1 Ignition	0
2 Flashover	257
3 Front Door Open	330
4 Flow from Stairs	351
5 Flow from Landing	376
6 Vertical Ventilation Completed	411
7 Flow from Fire Room Doorway	422
8 Suppression Crew Entered Fire Room	432

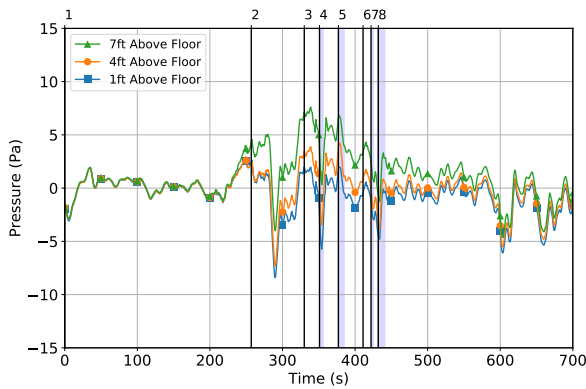

(b) Bedroom 2 Pressure

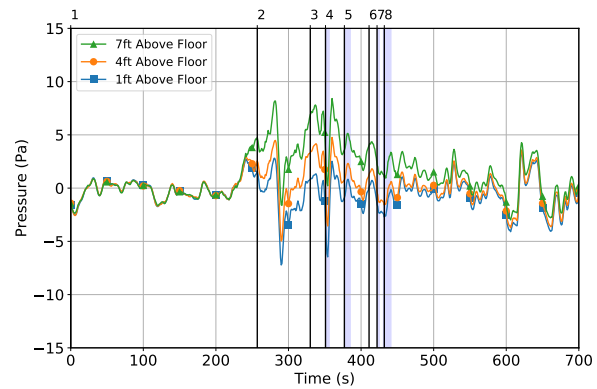

(c) Bedroom 1 Pressure

Figure 3.36: Pressure remote from fire room for Experiment 3. Blue vertical bars indicate time and duration of water flow.

The changes in flow during the experiment are illustrated in Figure 3.37. As the fire grew to a point where it became ventilation limited, bi-directional flows were created at the fire room windows, entraining fresh air into the fire room and exhausting hot gases out of the fire room. Bi-directional flow also existed at the fire room doorway—fresh air drawn into the fire room from remote parts of the structure was replaced with products of combustion (see Figure 3.37a). The opening of the front door created a more efficient flow path, allowing fresh air to flow into the structure through the front door and travel up the stairs and into the fire room, while hot gases exhausted from the upper portion of the fire room windows and doorway, as shown in Figure 3.37b. When the vertical vent over the fire room was completed following initial water flow, there was not a significant growth in the fire. The vertical vent increased the area available for ventilation. As shown in Figure 3.37c, additional hot gases were exhausted from the uni-directional exhaust through the ceiling. The fire room windows continued to act as bi-directional vents, with hot gases exhausting from the upper portion and fresh air replacing them through the lower portion.

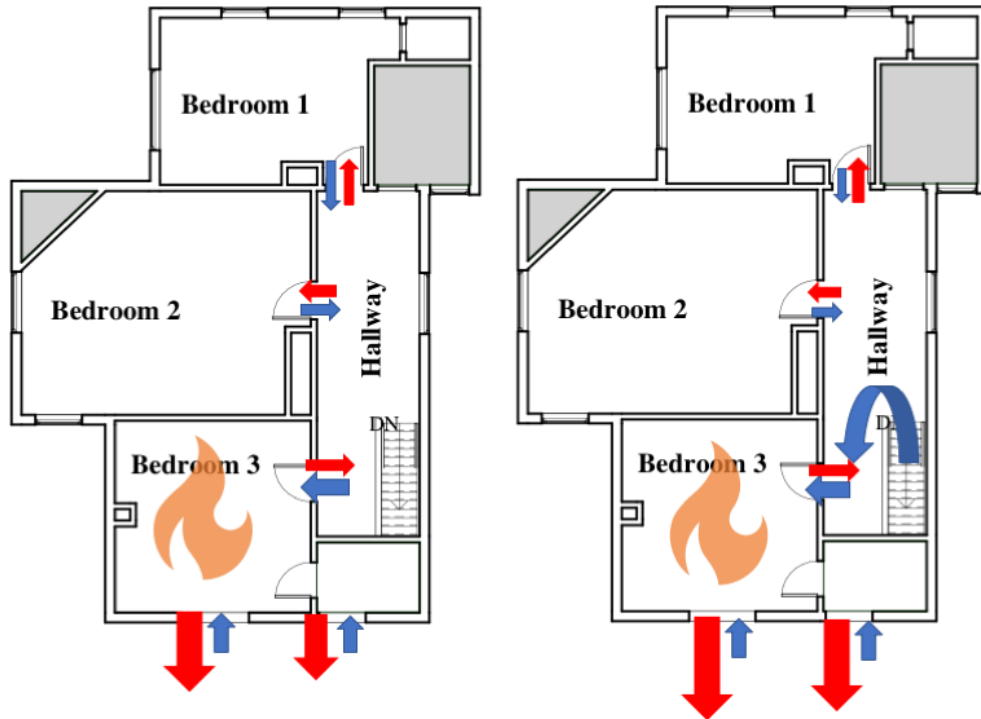

(a) Prior to Front Door Opened

(b) After Front Door Opened

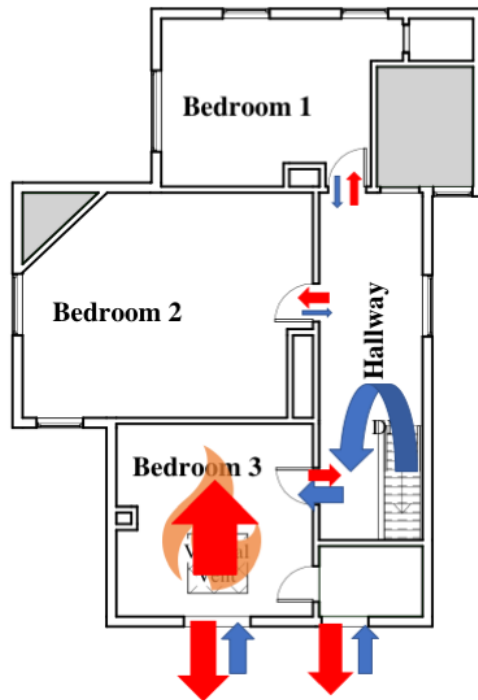

(c) After Vertical Ventilation

Figure 3.37: Changes in flow during Experiment 3. Red arrows indicate the flow of combustion products, blue arrows indicate the flow of fresh air, and the sizes of the arrows indicate the relative magnitude of the flow.

Gas concentrations were measured at the same locations as heat fluxes—1 ft and 3 ft above the floor in the hallway, and 1 ft above the floor in bedroom 2. The O₂ concentrations first began to decrease and the CO and CO₂ concentrations first started to decrease in the hallway as the fire room transitioned through flashover and oxygen was drawn from other spaces of the second-floor and replaced with products of combustion. At the time the front door was opened, the gas concentrations at both the 1 ft and 3 ft elevations in the hallway were still increasing. Both elevations reached a peak at the time of the stairway suppression action, after which they began to decrease toward pre-ignition conditions. The peak gas concentrations at 3 ft in the hallway were 12.5%, 4.0%, and 2.0% for O₂, CO₂, and CO, respectively. The peak 1 ft hallway gas concentrations were approximately 19.0%, 1.0%, and 1.0% for O₂, CO₂, and CO, respectively. The gas concentrations at both elevations steadily returned to pre-ignition values as vertical ventilation was completed and suppression continued. The CO concentrations at the 1 ft and 3 ft elevations in the hallway decreased below 0.1% 135 s and 97 s, respectively, after the front door was opened.

Gas concentrations in bedroom 2 took longer to change than in the hallway. CO₂ and CO first began to increase around the time of the stairway suppression action (Action 4). The O₂ continued to decrease and the CO₂ and CO continued to increase until the completion of the vertical vent, which stabilized gas concentrations. Gas concentrations in the hallway reached a peak 475 s post ignition, concurrently when the fire room gas concentrations had returned to pre-ignition conditions.

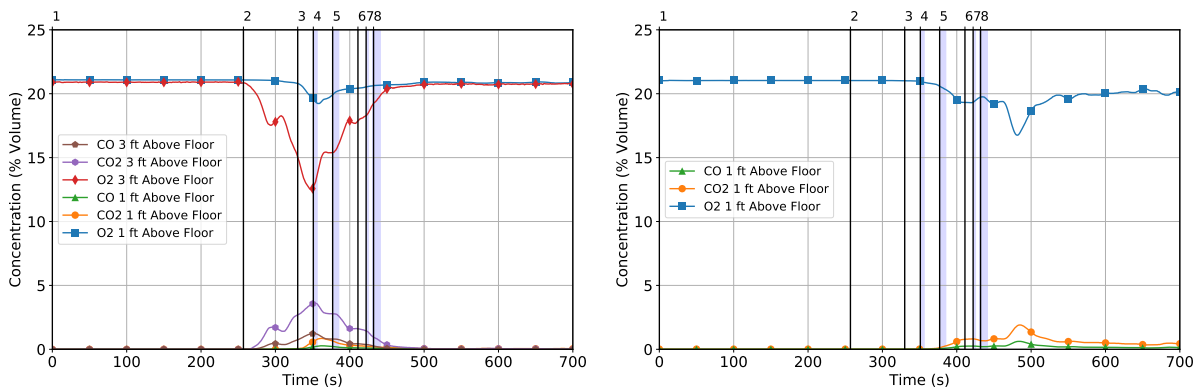

(a) Gas Concentrations in the Hallway

(b) Gas Concentrations in Bedroom 2

	Action/Event	Time (s)
1	Ignition	0
2	Flashover	257
3	Front Door Open	330
4	Flow from Stairs	351
5	Flow from Landing	376
6	Vertical Ventilation Completed	411
7	Flow from Fire Room Doorway	422
8	Suppression Crew Entered Fire Room	432

Figure 3.38: Gas concentrations for remote locations in Experiment 3. Blue vertical bars indicate time and duration of water flow.

3.4 Experiment 4 — Interior Suppression with Additional Horizontal Ventilation

Experiment 4 examined coordinated interior suppression with additional horizontal ventilation post knockdown. At 2401 Wapakoneta Avenue in Sidney, Ohio, a two-story, 4,576 sq ft, wood frame structure was instrumented to conduct this second-floor bedroom fire experiment. The four exterior sides of the structure appear in Figure 3.39. The structure was concrete block and brick with some stick-built additions using dimensional lumber framing with a combination of brick and vinyl siding. The foundation was a mix of poured concrete, concrete block and stone. The roof was a combination of a hip-style roof and a peaked roof using 1 in.-by-6 in. sheathing and plywood sheathing covered with asphalt shingles. Detailed dimensioned drawings for the first and second story appear in Appendix Figures B.7 and B.8, respectively.



Figure 3.39: Exterior photographs of the structure for Experiment 4.

This structure was partitioned into two separate, independent sub-structures. The rooms located

along side A (office, front entry room, and bedrooms 1 and 2) were isolated from the remaining rooms (rear entry room, bedrooms 3 and 4) within the structure. Two independent stairwells allowed this structure to be split so that the interior volume of the structure was similar to that of the other structures examined. The first-floor of the house partitioned for Experiment 2 had an office and front entry room while the second-floor contained bedroom 1, bedroom 2, and a stairwell landing. These rooms defined the experimental volume, accounting for 1,646 sq ft of the 4,576 sq ft. The structure was instrumented for temperature, pressure, heat flux, IR, and standard video to capture the fire dynamics during experimentation. Instrumentation was also installed to characterize the potential for skin burns and occupant toxic exposure during the experiment. Figure 3.40 shows the layout of the first and second-floors with the instrumentation locations.

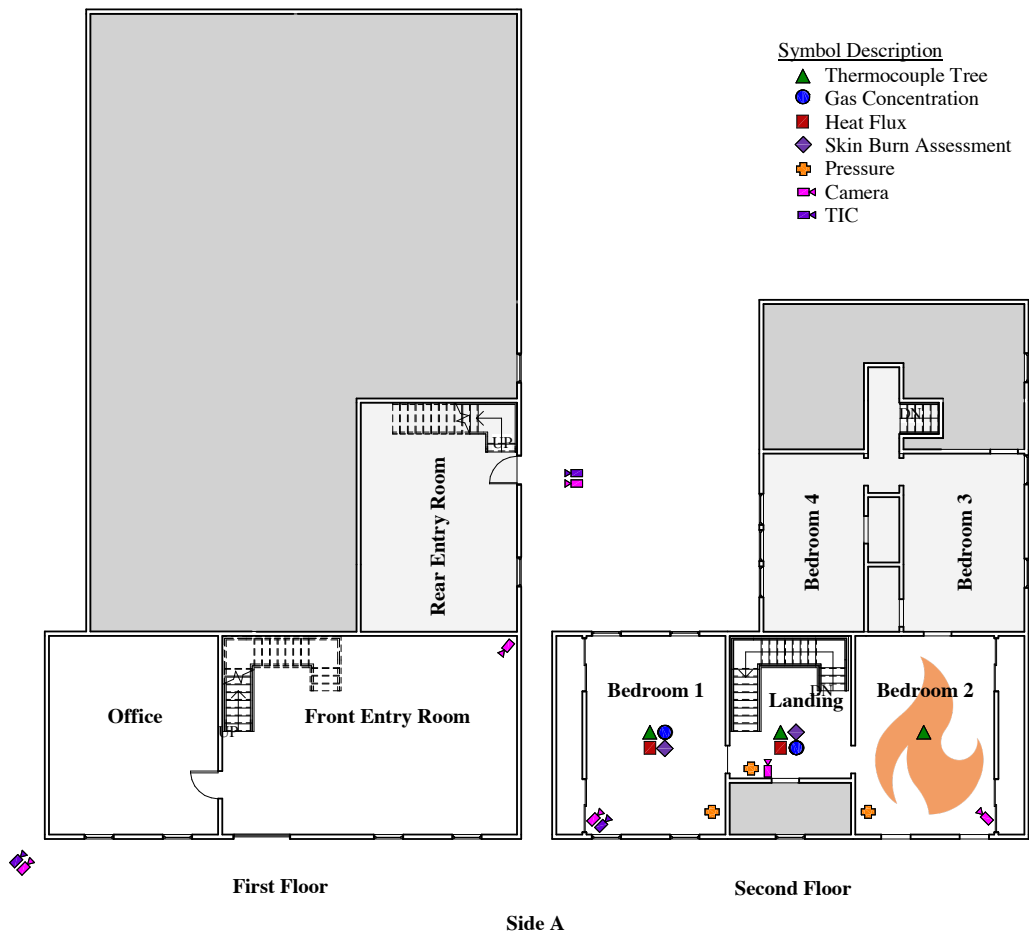

Figure 3.40: Instrumentation and floor plan for Experiment 4. The dark gray areas were isolated from the remainder of the structure and utilized as space for instrumentation. The light gray areas indicate the sub-structure not utilized for this experiment.

Bedroom 2, the fire room, was furnished with the bedroom fuel package described in Section 2.4.1. Photographs of the fire room prior to ignition are presented in Figure 3.41. A dimensioned layout

of the fire room is included in Figure 3.42.



(a) A/D Corner

(b) A/B Corner



(c) Side C Wall

Figure 3.41: Interior photographs of fire room for Experiment 4.

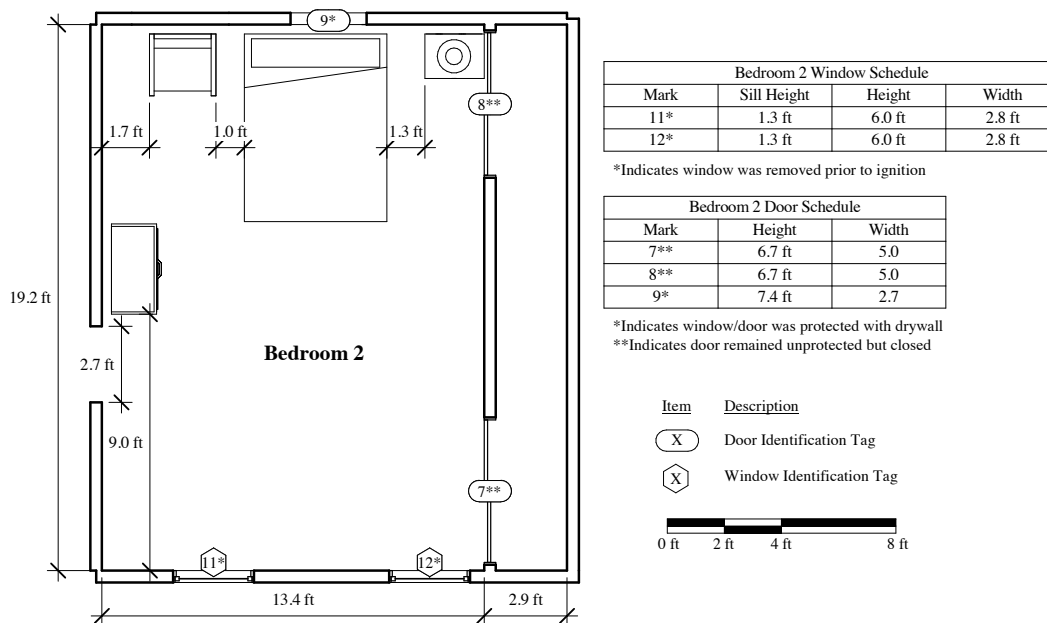

Figure 3.42: Fire room layout for Experiment 4.

Experiment 4 examined coordinated interior suppression with additional horizontal ventilation post knockdown. To replicate a similar volume of space found in other experiments, the rear entry was isolated from the front half of the first-floor, and bedroom 3, bedroom 4, and the hallway were isolated from the front half of the second-floor. These areas did not play a role in this experiment. To ensure repeatable fire growth and a sufficient oxygen supply for flashover, the windows labeled 15 and 16 in Figure 3.42 were removed prior to ignition.

The fire was ignited in the upholstered chair next to the mattress in bedroom 2 ($t = 0$ s). The fire was observed from the side A windows (labeled 15 and 16 in Figure 3.42) shortly afterward, 209 s (3:29) post ignition. The room transitioned through flashover 231 s (3:51) post ignition (Event 2) and remained in a post-flashover state until the door was opened.

The initial fire department intervention was the opening of the front door, which occurred 420 s (7:00) post ignition. The suppression crew entered through the front door 10 s later and proceeded up the steps with a 1.75 in. hoseline with a combination nozzle set to straight stream. The initial suppression action occurred halfway up the stairway, occurring 443 s post ignition for 7 s. After reaching the top of the stairs, the crew flowed water from the doorway into the fire room at 459 s post ignition for 38 s. The ventilation crew opened both windows in the remote bedroom (bedroom 1) at 467 s post ignition. The suppression crew made entry to the fire room for final suppression at 499 s post ignition.

The total tactic time from initial ventilation (front door open) to initial suppression was 47 s (00:47). The total water used for initial suppression was 102 gal, which does not include water flowed during mop-up operations. The suppression and ventilation sequence, complete with the

locations of each action, is shown in Figure 3.43.

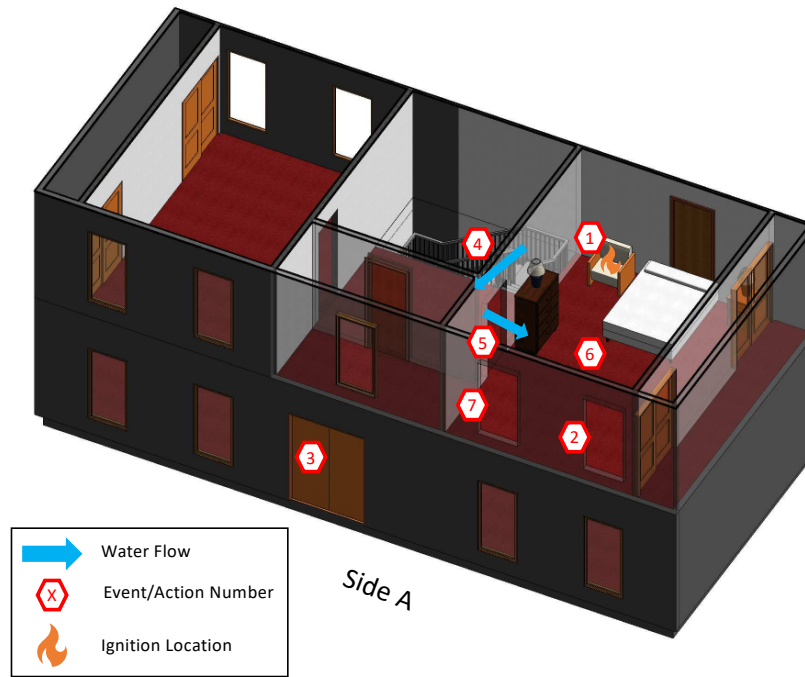

Action/Event	Time (mm:ss)	Time (s)
1 Ignition	00:00	0
2 Flashover	03:51	231
3 Front Door Open	07:00	420
4 Flow from Stairs	07:21	441
5 Flow from Fire Room Doorway	07:39	459
6 Bedroom 1 Windows Opened	07:49	469
7 Suppression Crew Entered Fire Room	08:19	499

Figure 3.43: Time and sequence of actions and events for Experiment 4.

Shortly after the fire was ignited in the upholstered chair next to the mattress in bedroom 2, temperatures began to increase in the fire room, as shown in Figure 3.44. Fire was observed exhausting from the doorway of the fire room into the stairway landing 198 s post ignition. The fire room temperatures remained relatively stable in the time between the opening of the front door and the initial suppression action from the stairway (Action 4). The stairway suppression caused a brief reduction in temperatures, but the suppression from the fire room doorway was the more effective of the two suppression actions (Action 5), decreasing the fire room temperatures to values close to their final temperatures.

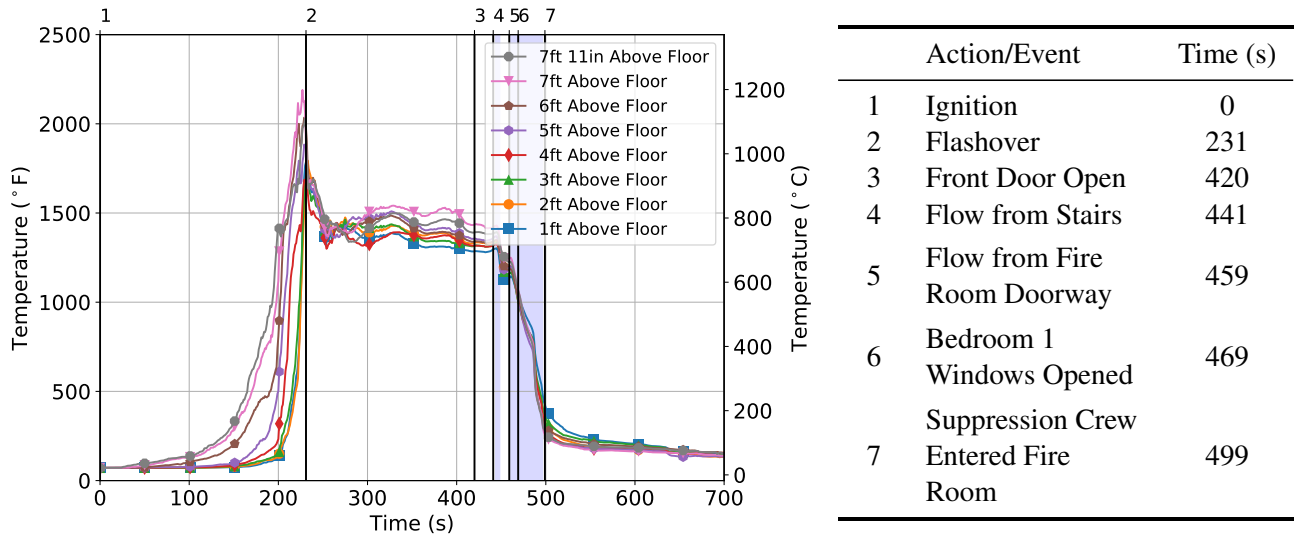
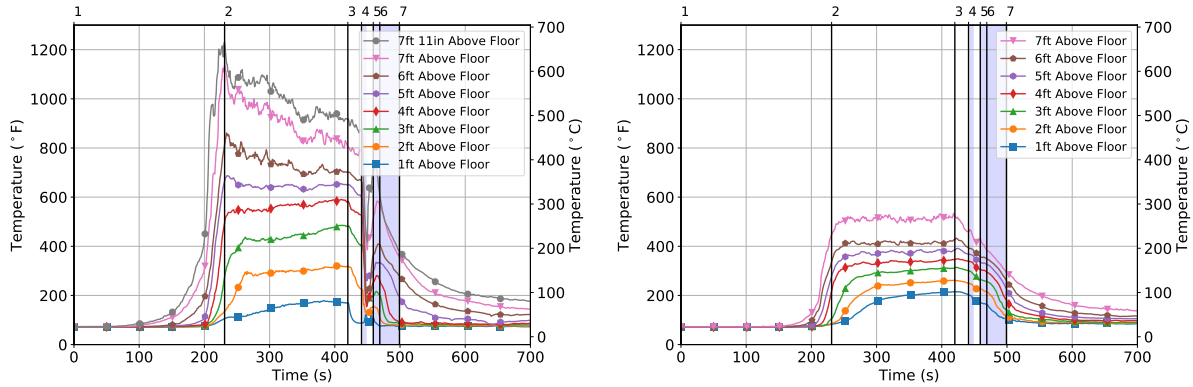

Figure 3.44: Fire room (bedroom 2) temperatures for Experiment 4. Blue vertical bars indicate time and duration of water flow.

Figure 3.45 shows the temperatures in the stairway landing and bedroom 1. Temperatures in the stairway landing began to increase rapidly at approximately the time fire began to exhaust from the fire room into the stairway landing. The peak temperatures close to the ceiling were measured at the time of flashover. Temperatures closer to the floor were considerably less, indicating air was entrained from remote areas of the structure. The landing temperatures at the time the front door was opened were steady, ranging from 915 °F at the ceiling to 170 °F 1 ft above the floor. Temperatures close to the floor gradually decreased as a flow path was established from the front door to the fire room and fresh air was entrained into the fire room. The initial suppression action in the stairway (Action 4) decreased temperatures at all elevations throughout the stairway landing, although they regrew before the suppression crew began to apply water in the doorway. Once the suppression crew continued suppression in the fire room doorway, temperatures decreased again.



(a) Temperature on the Stairway Landing

(b) Temperature in Bedroom 1

	Action/Event	Time (s)
1	Ignition	0
2	Flashover	231
3	Front Door Open	420
4	Flow from Stairs	441
5	Flow from Fire Room Doorway	459
6	Bedroom 1 Windows Opened	469
7	Suppression Crew Entered Fire Room	499

Figure 3.45: Remote temperatures for Experiment 4. Blue vertical bars indicate time and duration of water flow.

The temperatures in bedroom 1 followed a similar trend to those in the stairway landing. Temperatures initially increased approximately 175 s post ignition, reached a steady state prior to fire department intervention, and then began to decrease after the front door was opened. While the effects of suppression were not as immediate as in the stairway landing, as suppression continued, the temperatures began to decrease more rapidly.

Heat flux was measured at three locations—1 ft and 3 ft above the floor in the hallway landing and 1 ft above the floor in bedroom 1. The hallway landing heat fluxes first started to increase shortly before flashover, reaching peaks of 2.3 kW/m² and 3.1 kW/m² at 1 ft and 3 ft, respectively. The heat flux remained approximately steady through the time the front door was opened. The stairway heat flux decreased at both elevations following the opening of the front door, as fresh air was entrained into the fire room through the stairwell. The heat flux continued to decrease as the suppression crew advanced into the fire room itself.

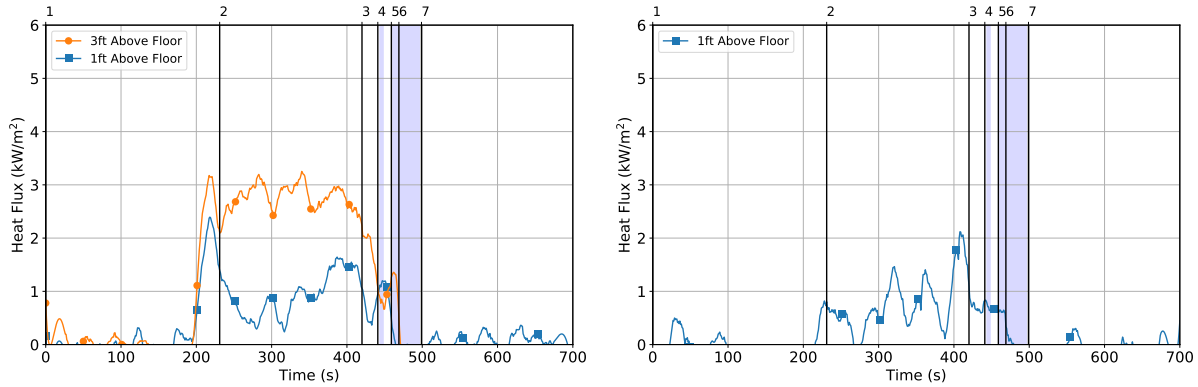

(a) Heat Flux on the Stairway Landing

(b) Heat Flux in Bedroom 1

Action/Event	Time (s)
1 Ignition	0
2 Flashover	231
3 Front Door Open	420
4 Flow from Stairs	441
5 Flow from Fire Room Doorway	459
6 Bedroom 1 Windows Opened	469
7 Suppression Crew Entered Fire Room	499

Figure 3.46: Heat flux at remote locations for Experiment 4. Blue vertical bars indicate time and duration of water flow.

The heat flux in bedroom 1 also began to increase around the time of flashover, and continued to increase to a 2 kW/m^2 peak corresponding with the front door opening. The opening of the front door decreased the 1 ft bedroom 1 heat flux below 1 kW/m^2 . Suppression from the doorway decreased heat fluxes to background levels.

Like the fire room temperatures, the fire room pressure (see Figure 3.47a) began to increase shortly after ignition, as the smoke layer began to develop close to the ceiling. As the fire continued to grow, 4 ft pressure began to increase and the 1 ft pressure began to decrease, as a bi-directional flow path was established through both fire room windows and the fire room doorway. The pressures then adopted a steady profile at 12 Pa, 4 Pa, and -4 Pa at 7 ft, 4 ft, and 1 ft, respectively. The opening of the front door decreased the 1 ft pressure in the fire room as additional air was entrained via the new flow path. The stairway suppression action resulted in a decrease in the pressure magnitude at all three locations. Pressures continued to converge to background levels as suppression was continued from the fire room doorway.

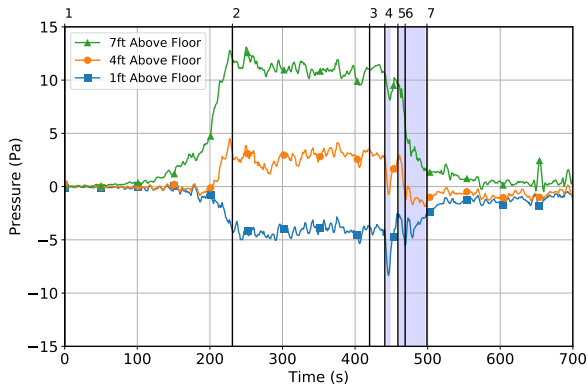

(a) Bedroom 2 Pressure

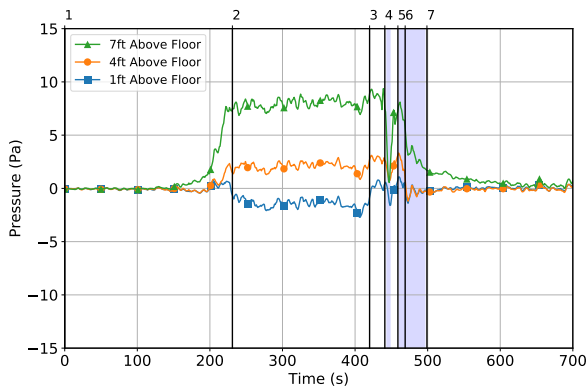

(b) Stairway Landing Pressure

	Action/Event	Time (s)
1	Ignition	0
2	Flashover	231
3	Front Door Open	420
4	Flow from Stairs	441
5	Flow from Fire Room Doorway	459
6	Bedroom 1 Windows Opened	469
7	Suppression Crew Entered Fire Room	499

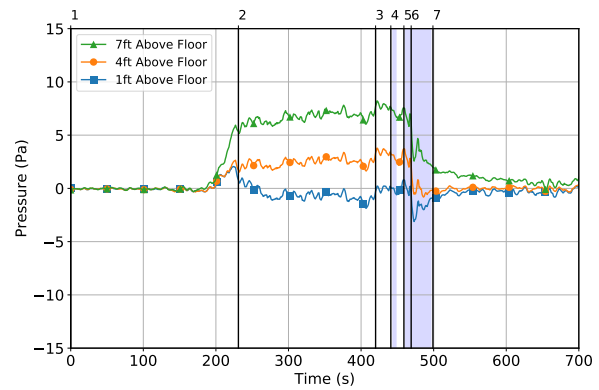

(c) Bedroom 1 Pressure

Figure 3.47: Second-floor pressure for Experiment 4. Blue vertical bars indicate time and duration of water flow.

Remote from the fire room, the pressures in the stairway landing (see Figure 3.47b) and bedroom 1 (see Figure 3.47c) followed a similar trend to the fire room pressures, although the magnitude of the pressures in these areas were less than the fire room. This indicates that as the fire grew, hot gases were exhausted to remote areas of the structure while fresh air was entrained to the fire room from these remote areas. After the front door was opened, the 1 ft pressure in both the stairway landing and bedroom 2 increased above 0 Pa, reflecting the entrainment of air via the open front door. Once the bedroom 1 windows were opened (Event 6), the pressure at all three elevations in bedroom 1 decreased, with the 1 ft and 4 ft pressures decreasing below 0 Pa as smoke was exhausted and fresh air was entrained.

The pressure data shows that as the fire grew and became ventilation limited, bi-directional flow paths were established through the fire room windows and fire room doorway (see Figure 3.48a). Once the front door was opened, an additional flow path was created through the front door. Fresh air flowed along this flow path, as it was entrained to the fire through the front door, up the stairs, and into the fire room. The windows were bi-directional vents (see Figure 3.48b). As suppression occurred, the fire transitioned from ventilation limited to fuel limited, meaning that the additional ventilation in bedroom 1 (Action 7) did not result in additional fire growth. Rather, it created additional flow paths through the bedroom 1 windows (see Figure 3.48c), products of combustion were exhausted and replaced with fresh air.

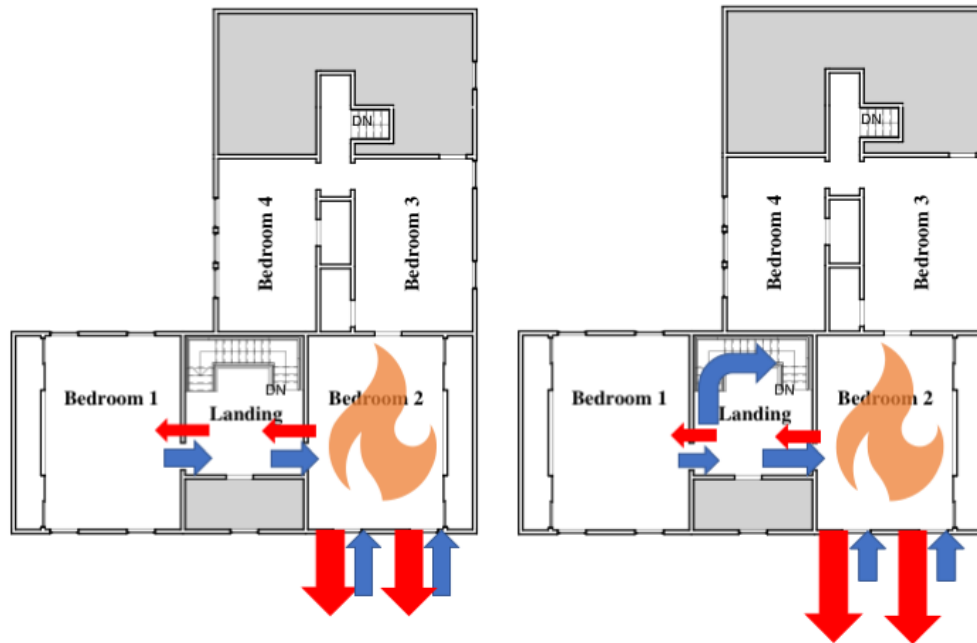

(a) Prior to Front Door Opened

(b) After Front Door Opened

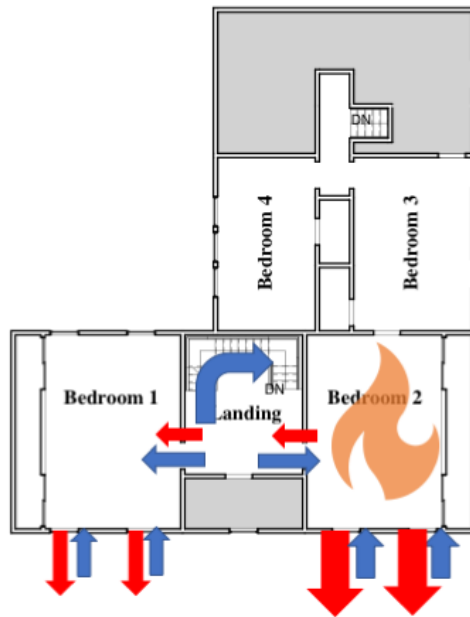

(c) After Horizontal Ventilation

Figure 3.48: Changes in flow during Experiment 4. Red arrows indicate the flow of combustion products, blue arrows indicate the flow of fresh air, and the sizes of the arrows indicate the relative magnitude of the flow.

These changes in flow path were reflected in the gas concentrations (see Figure 3.49), which were measured 1 ft and 3 ft above the floor in the stairway and 1 ft above the floor in bedroom 1. The

gas concentrations in the stairway began to increase as the fire room transitioned through flashover. Because the fresh air was entrained through the front door and up the stairs to the fire room, the stairway gas concentrations were less than those measured in bedroom 2. The 3 ft stairway gas concentrations peaked after the opening of the front door, reaching an O₂ minimum and CO₂, and CO maximums of 15.0%, 7.0%, and 1.0%, respectively. The stairway suppression action caused the gas concentrations to begin to decrease, and as suppression continued from the fire room doorway, the gas concentrations continued to decrease.

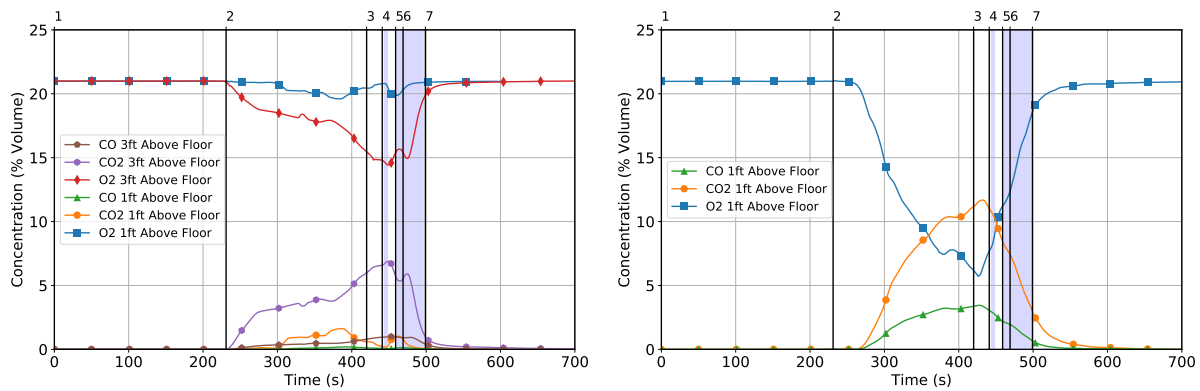

(a) Gas Concentration on the Stairway Landing

(b) Gas Concentration in Bedroom 1

	Action/Event	Time (s)
1	Ignition	0
2	Flashover	231
3	Front Door Open	420
4	Flow from Stairs	441
5	Flow from Fire Room Doorway	459
6	Bedroom 1 Windows Opened	469
7	Suppression Crew Entered Fire Room	499

Figure 3.49: Gas concentrations at 1 ft and 3 ft in stairway landing (see Figure 3.49a) and in the remote bedroom (see Figure 3.49b) for Experiment 4. Blue vertical bars indicate time and duration of water flow.

The bedroom 1 gas concentrations did not begin to change until after the stairway landing concentrations. The peak bedroom 1 O₂ concentration was less and the peak CO₂ and CO concentrations were greater than in the stairway landing. The peak O₂, CO₂, and CO concentrations were 6.0%, 11.0%, and 3.0%, respectively. The greater gas concentrations in this remote location can be attributed to the lack of fresh air flowing through this location, as was the case in the stairway. The gas concentrations began to approach pre-ignition values after the front door was opened, suppression, and ventilation of the bedroom 1 windows.

3.5 Experiment 5 — Interior Suppression with Positive Pressure Ventilation

Experiment 5 examined coordinated interior suppression with positive pressure ventilation post knockdown. At 2401 Wapakoneta Avenue in Sidney, Ohio, a two-story, 4,576 sq ft, wood frame structure was instrumented to conduct this second-floor bedroom fire experiment. The four exterior sides of the structure appear in Figure 3.50. Note: That in contrast to Experiments 2 and 4, side A was designated for the secondary structure entrance in this experiment. The structure was concrete block and brick with some stick-built additions using dimensional lumber framing with a combination of brick and vinyl siding. The foundation was a mix of poured concrete, concrete block and stone. The roof was a combination of a hip-style roof and a peaked roof using 1 in.-by-6 in. sheathing and plywood sheathing covered with asphalt shingles. Detailed dimensioned drawings for the first and second story appear in Appendix Figures B.7 and B.8, respectively.



(a) Side A



(b) Side B



(c) Side C



(d) Side D

Figure 3.50: Exterior photographs of the structure for Experiment 5.

This structure contained two stairwells, allowing the structure to be partitioned into two separate, independent sub-structures. The interior volume of each sub-structure was similar. The first-floor of the house partitioned for Experiment 5 had a rear entry room while the second-floor contained bedroom 3 and bedroom 4. The rear stairwell connected these two floors, and together they formed the experimental volume of the structure, accounting for 837 sq ft of the 4,576 sq ft. The structure was instrumented for temperature, pressure, heat flux, IR, and standard video to capture the fire dynamics during experimentation. Instrumentation was also installed to characterize the potential for skin burns and occupant toxic exposure during the experiment. Figure 3.51 shows the layout of the first and second-floors with the instrumentation locations.

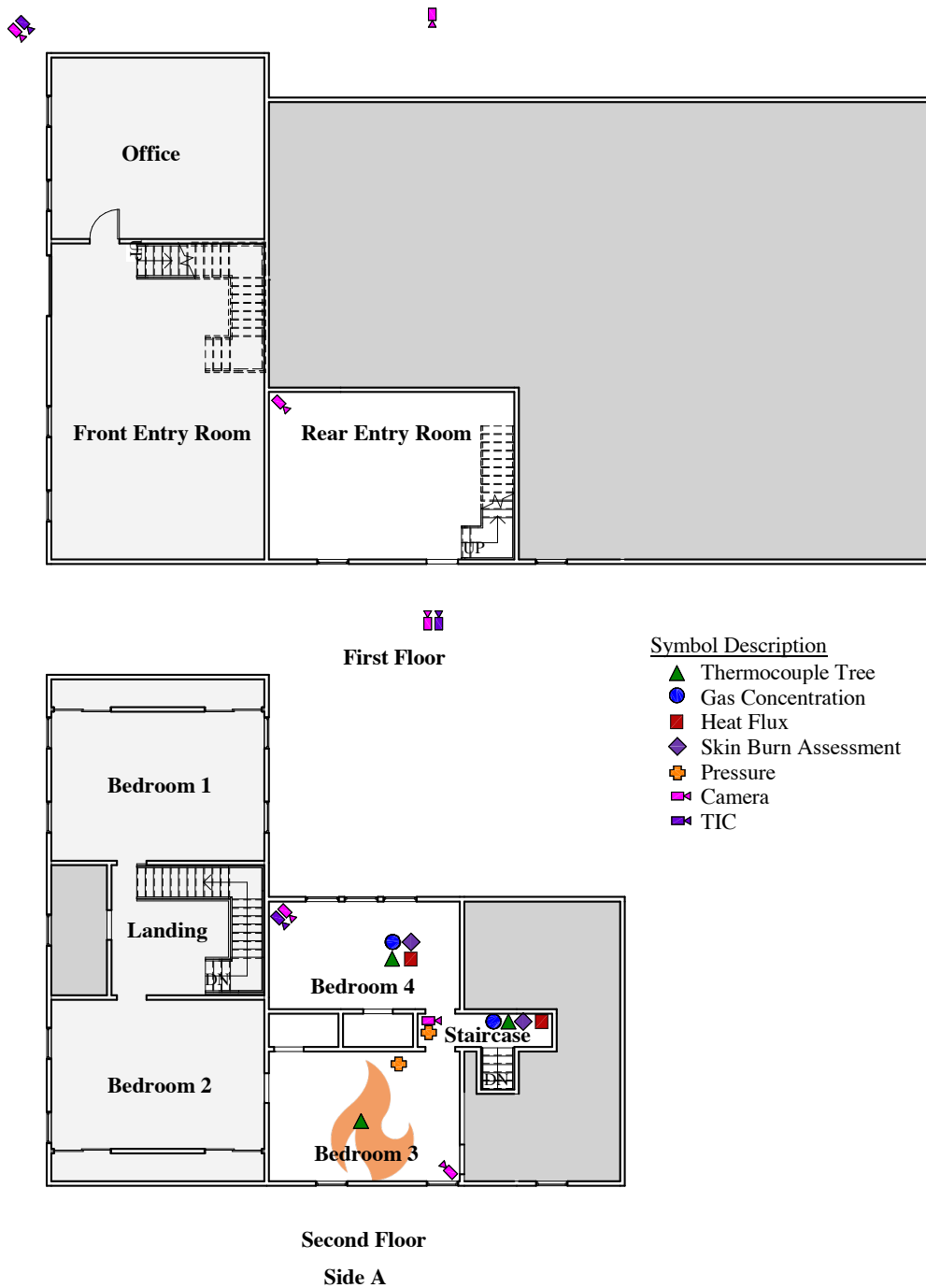

Figure 3.51: Instrumentation and floor plan for Experiment 5. The dark gray areas were isolated from the remainder of the structure and utilized as space for instrumentation. The light gray areas indicate the sub-structure not utilized for this experiment.

Bedroom 3, the fire room, was furnished with the bedroom fuel package described in Section 2.4.1.

Photographs of the fire room, bedroom 3, prior to ignition are presented in Figure 3.52. A dimensioned layout of the fire room is included in Figure 3.53.



(a) Side A Wall

(b) Side B Wall

(c) Side D Wall

Figure 3.52: Interior photographs of fire room for Experiment 5.

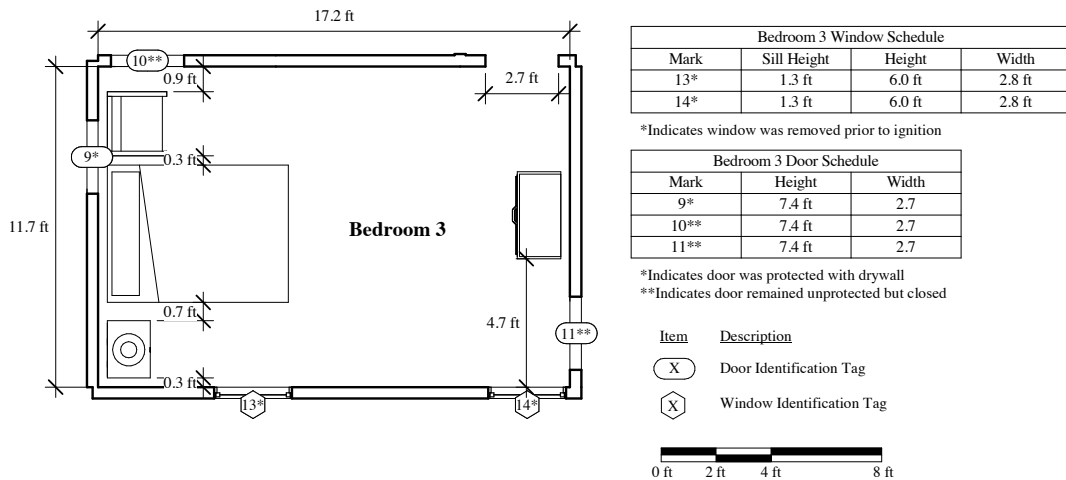

Figure 3.53: Fire room layout for Experiment 5.

Experiment 5 examined coordinated interior suppression with positive pressure ventilation post knockdown. To replicate a similar volume of space found in other experiments, the front entry and office were isolated from the right side of the first-floor, and bedroom 1, bedroom 2, landing were isolated from the right side of the second-floor. These areas did not play a role in this experiment. To ensure repeatable fire growth and a sufficient oxygen supply for flashover, the windows labeled 13 and 14, shown in Figure 3.53, were removed prior to ignition.

The fire was ignited in the upholstered chair ($t = 0$ s) in bedroom 3. The fire grew, producing smoke visible from the side A windows at 161 s (2:41). Visible flames from the leftmost side A window (labeled 13 in Figure 3.53) were apparent at 220 s (3:40) post ignition. Continuously venting flames were apparent from both side A windows at 246 s (4:06) post ignition. Flashover occurred just after at 253 s (4:13) post ignition. The fire transitioned through flashover to a steady state before any fire department intervention.

Fire department intervention began with the front door opening at 421 s (7:01) post ignition. The suppression crew entered 10 s after the front door was opened and advanced halfway up the stairway. The stream was directed toward the top of the landing at 440 s (7:20) post ignition for a duration of 5 s. The crew advanced to the top of the stairwell before flowing a second time (8 s) and at the fire room doorway before flowing a third time (16 s), occurring 454 s (7:34) and 466 s (7:46) post ignition, respectively. Once the suppression crew entered the fire room for final suppression 471 s (7:51) post ignition, a fan¹ was turned into position at the front door to start positive pressure ventilation at 479 s (7:59) post ignition.

A single 1.75 in. hoseline with a combination nozzle set to straight stream was utilized for interior suppression. The fan was started and placed into position at the front door after the suppression crew entered the structure and made their way to the fire room. The fan was placed approximately 5 ft from the door at an angle of 95° with the ground. The total tactic time from initial ventilation of the front door to suppression was 50 s (00:50). The total water flowed for initial suppression was 166 gal, which does not include water used for mop-up operations. Figure 3.54 lists these events and actions, along with their relative locations, on an isometric view of the structure.

¹Manufacturer specifications: 18 in. diameter, gas-powered, 14,773 CFM.

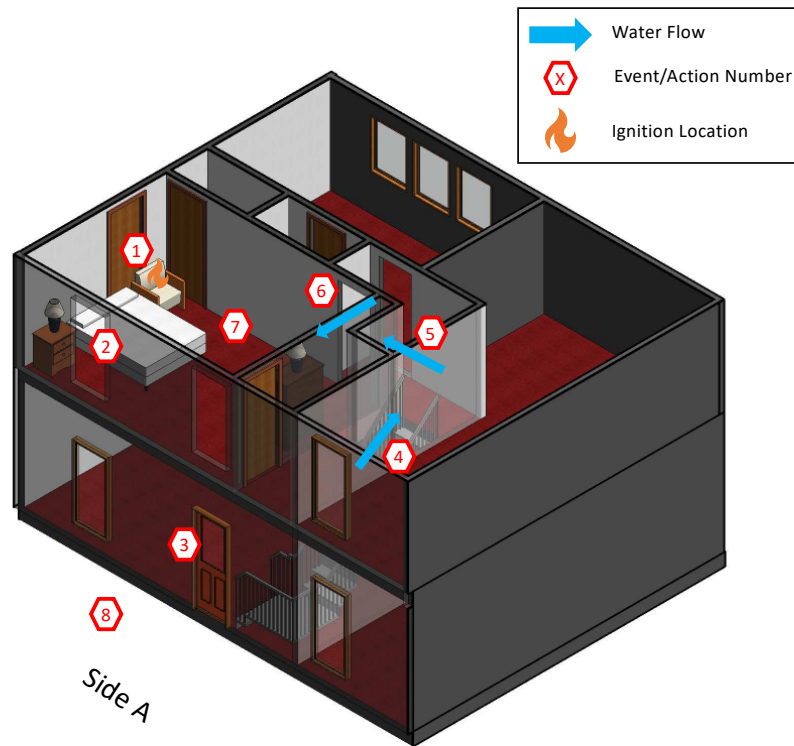

Action/Event	Time (mm:ss)	Time (s)
1 Ignition	00:00	0
2 Flashover	04:13	253
3 Front Door Open	07:01	421
4 Flow from Stairs	07:20	440
5 Flow from Landing	07:34	454
6 Flow from Fire Room Doorway	07:46	466
7 Suppression Crew Entered Fire Room	07:51	471
8 PPV Fan Turned In	07:59	479

Figure 3.54: Time and sequence of actions and events for Experiment 5.

Temperatures nearest the ceiling in the fire room (bedroom 3) began to increase approximately 40 s post-ignition. The fire in the chair started to spread to the bed between 50 s and 100 s post ignition. This spread corresponded to a temperature increase at all elevations in the fire room. Flames were observed extending from the fire room into the hallway 237 s post ignition as temperatures within the fire room began increasing toward flashover. The fire room transitioned to flashover shortly afterwards, 253 s into the experiment. The fire remained in a post-flashover state until the front door was opened. The initial suppression action from the stairway (Action 4) did not result in a noticeable decrease in temperatures. This is likely due to the geometry of the stairway landing,

which prevented water from reaching the fire room. A brief increase in temperatures was observed immediately after this suppression action, indicating the fresh air entrainment from the front door caused fire growth. A thermal flow was evident from firefighter video footage (456 s post ignition) upon reaching the landing. The second suppression action (Action 5) was effective in reducing temperatures within the fire room. The suppression crew advanced to the fire room doorway and began flowing water. This suppression action compromised the thermocouple array in the fire room, so the data after this point has not been included. As such, it is unclear when temperatures reached pre-ignition conditions. But further suppression actions continued to decrease fire room temperatures, allowing the suppression crew to make entry for final suppression.

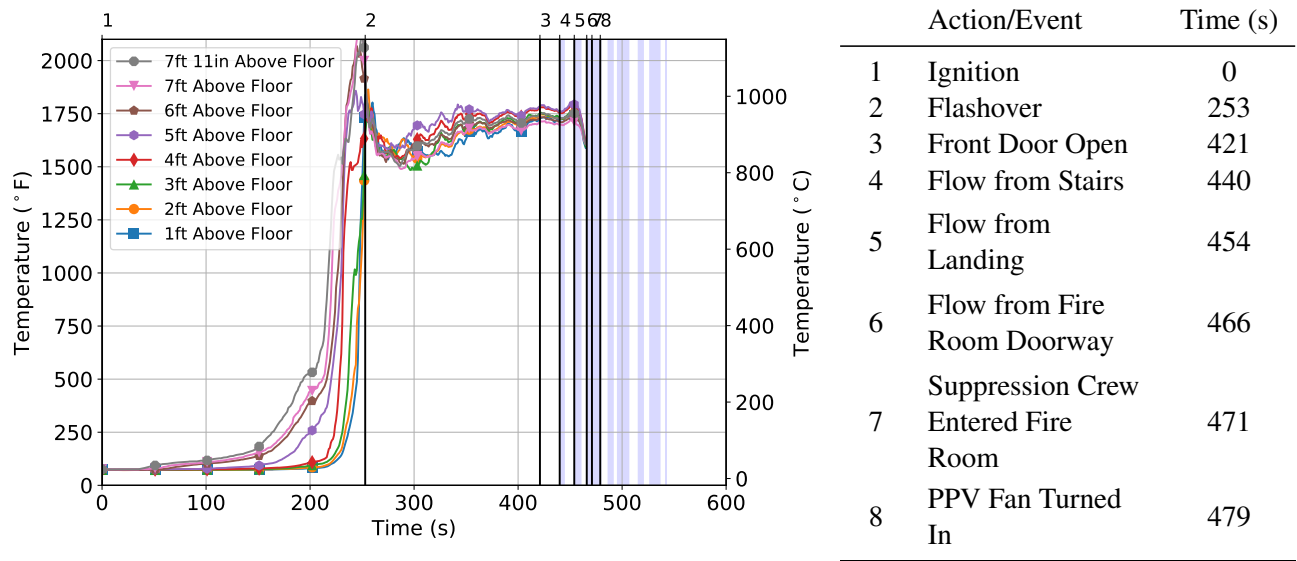
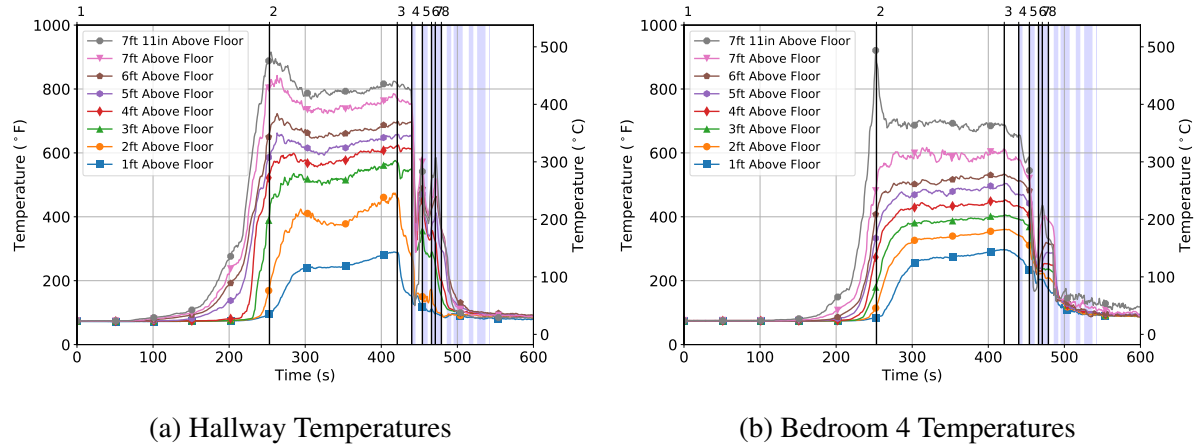

Figure 3.55: Fire room (bedroom 3) temperatures for Experiment 5. Blue vertical bars indicate time and duration of water flow. Water flow from the fire room doorway compromised the thermocouple array, and data beyond this action has not been included.

Temperatures in the hallway, shown in Figure 3.56a, first began to increase approximately 60 s post ignition as smoke from the fire room first began to spread throughout the structure. The temperatures began to increase more rapidly as flames began to roll into the stairway landing, reaching a peak at the time bedroom 3 reached flashover. The temperatures in the hallway remained relatively steady through the post-flashover period, ranging from 820 °F close to the ceiling to 294 °F 1 ft above the floor. The opening of the front door resulted in a decrease in the 1 ft and 2 ft temperatures, which was the intake portion of a flow path established from the front door to the fire room. The initial suppression action in the stairway cooled temperatures 3 ft above the floor from 544 °F to 294 °F. This allowed the suppression crew to advance to the top of the stairway to continue suppression from that location and the fire room doorway, which were both effective at cooling temperatures not only in the stairway landing, but also in the fire room and bedroom 4. While the hallway temperatures rebounded after both the stairway suppression and the landing suppression actions, temperatures decreased permanently after suppression within the fire room.



Action/Event	Time (s)
1 Ignition	0
2 Flashover	253
3 Front Door Open	421
4 Flow from Stairs	440
5 Flow from Landing	454
6 Flow from Fire Room Doorway	466
7 Suppression Crew Entered Fire Room	471
8 PPV Fan Turned In	479

Figure 3.56: Remote temperatures for Experiment 5. Blue vertical bars indicate time and duration of water flow.

The temperatures in bedroom 4 (see Figure 3.56) began to increase later in the experiment than in the stairway landing, approximately 150 s post ignition. The temperatures began to increase more rapidly as bedroom 3 transitioned through flashover, with the 7 ft 11 in. temperature reaching a peak during flashover. The bedroom 4 temperatures were steady at the time the front door was opened, ranging from 690 °F close to the ceiling to 300 °F 1 ft above the floor. After the front door was opened, temperatures began to gradually decrease. The suppression action from the stairway landing (Action 5) reduced temperatures in bedroom 4, although they rebounded during the water application in the fire room doorway. Just before entering the fire room to complete extinguishment, the suppression crew applied a brief, 7 s burst of water into bedroom 4. This action, combined with the activation of the fan for PPV, reduced temperatures below 150 °F for the duration of the test.

Heat flux was measured 1 ft and 3 ft above the floor in the hallway and 1 ft above the floor in the center of bedroom 4. The heat fluxes at the three locations are shown in Figure 3.57. In the hallway, the heat flux at 1 ft and 3 ft elevations began to increase shortly before flashover, as flames extended out of the bedroom door. The 1 ft heat flux gradually increased during this period to a peak of 1.9 kW/m² at the time the front door was opened, while the 3 ft heat flux remained relatively steady between 3.5 kW/m² and 5 kW/m². The fresh air entrained from the front door opening decreased the heat flux at both elevations, although the decrease was greater at the 1 ft

elevation. The 3 ft heat flux briefly decreased with the initial suppression action from the stairway, although it quickly rebounded. The subsequent suppression actions from the stairway landing and fire room doorway permanently decreased the 3 ft heat flux from 3.5 kW/m² to 0 kW/m². Similarly, after the decrease from the front door opening, the 1 ft heat flux recovered before the stairway landing suppression action permanently decreased the 1 ft hallway heat flux.

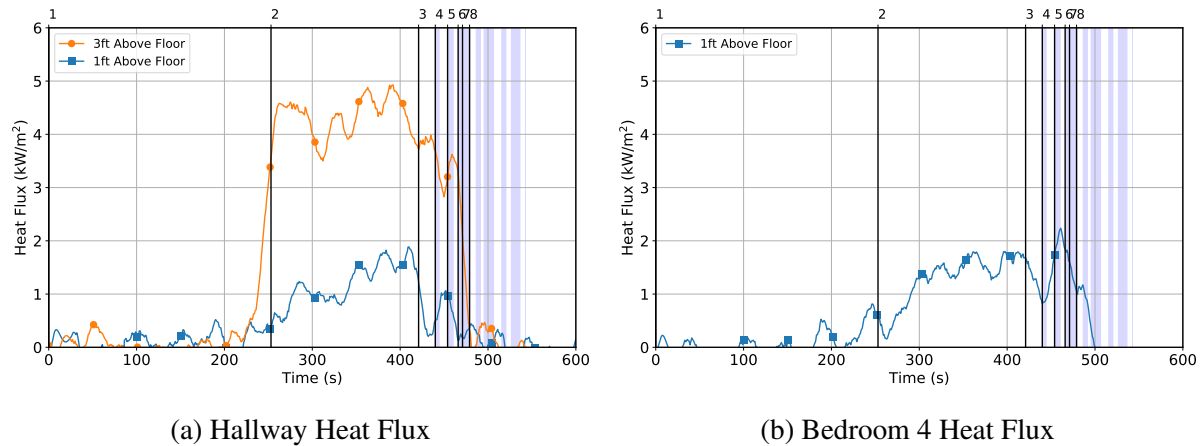

Action/Event	Time (s)
1 Ignition	0
2 Flashover	253
3 Front Door Open	421
4 Flow from Stairs	440
5 Flow from Landing	454
6 Flow from Fire Room Doorway	466
7 Suppression Crew Entered Fire Room	471
8 PPV Fan Turned In	479

Figure 3.57: Heat flux in hallway and bedroom 4 for Experiment 5. Blue vertical bars indicate time and duration of water flow.

Similar to the 1 ft heat flux in the stairway, the 1 ft heat flux in bedroom 4 began to increase as the fire room transitioned through flashover and the smoke layer descended in bedroom 4. The heat flux gradually increased during the post-flashover period, reaching a local peak of 1.8 kW/m² shortly before the front door was opened. The heat flux briefly decreased as fresh air was entrained by the opening of the front door, but increased to a peak of 2.2 kW/m² during the initial suppression action. As suppression continued in the fire room doorway, the heat flux decreased permanently.

The fire room pressures in Experiment 5 began to increase as the fire grew and the hot gas layer started to develop and gases expanded. The 7 ft pressure and 4 ft pressure first started to increase 125 s and 210 s post ignition, respectively. At the same time the 4 ft pressure started to increase, the 1 ft pressure decreased below 0 Pa, which indicates a bi-directional flow through the fire room vents. This pressure profile was maintained until the front door was opened, with pressures of 13.0 Pa, 4.0 Pa, and -4.0 Pa at 7 ft, 4 ft, and 1 ft above the floor, respectively. The fire growth after

the front door was opened is reflected by an increase in pressure prior to the initial suppression action. Although the stairway suppression action did not significantly decrease fire room temperatures, it did result in a decrease in pressure at all three elevations in the fire room. As suppression continued, the 7 ft, 4 ft, and 1 ft continued to decrease. The decrease in 1 ft pressure can likely be attributed to gas contraction. The combination of the fan used for PPV and suppression actions reduced pressures below 0 Pa for the duration of the test. The pressure in the hallway increased during this period, indicating air was flowing from the stairway into the fire room.

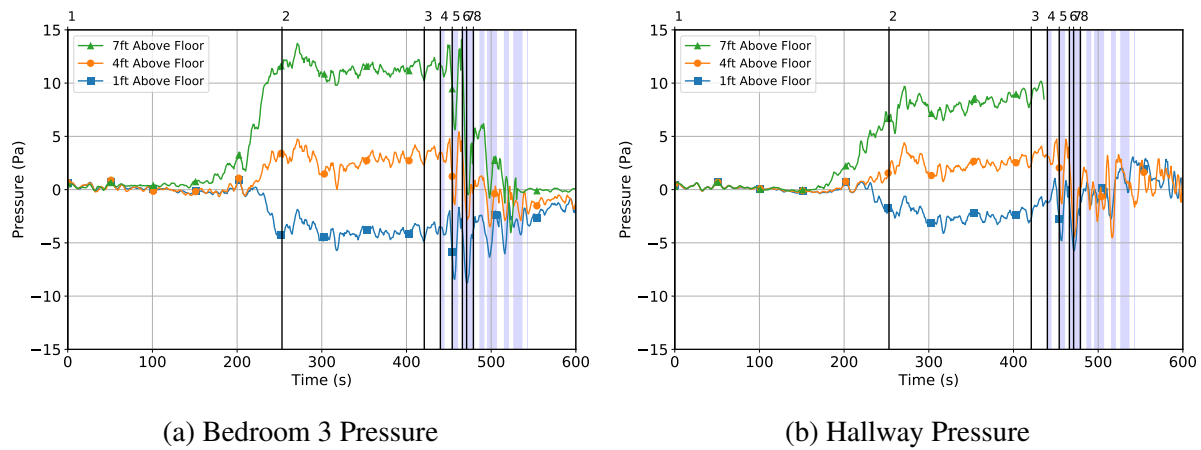

	Action/Event	Time (s)
1	Ignition	0
2	Flashover	253
3	Front Door Open	421
4	Flow from Stairs	440
5	Flow from Landing	454
6	Flow from Fire Room Doorway	466
7	Suppression Crew Entered Fire Room	471
8	PPV Fan Turned In	479

Figure 3.58: Second-floor pressures for Experiment 5. Blue vertical bars indicate time and duration of water flow.

The pressures in the hallway followed a similar trend to those in the fire room, although the magnitude of the pressures was less. This indicates that as the fire grew, hot gases were exhausted from the fire room into the hallway and fresh air was entrained into the fire room from remote parts of the structure. Once the front door was opened, the 1 ft pressure started to increase. The 7 ft pressure sensor was damaged 436 s post ignition, when water clogged the sample port. The pressure at both the 1 ft and 4 ft elevations decreased significantly during each suppression action, reflecting the contraction of hot gases and the entrainment of fresh air behind the hoseline. Approximately 15 s after the PPV fan was turned in, the 1 ft and 4 ft pressures increased above 0 Pa, and remained relatively steady for the rest of the experiment.

The changes in flow during the experiment are illustrated in Figure 3.59. As the fire grew to

ventilation limited state, there was bi-directional flow at the fire room windows; fresh air entrained into the fire room and hot gases exhausted out of the fire room. There was also bi-direction flow at the fire room doorway, drawing fresh air from remote parts of the structure to the fire room and replacing it with products of combustion, as shown in Figure 3.59a. The opening of the front door allowed fresh air to flow into the structure and travel up the stairs and into the fire room. Hot gases exhausted from the upper portion of the fire room windows and doorway, as shown in Figure 3.59b. After the suppression crew began flowing water from the stairway, doorway, and inside of the fire room, a fan was activated for PPV. The fan increased the flow rate of fresh air through the front door and the exhaust through the fire room windows, as seen in Figure 3.59c.

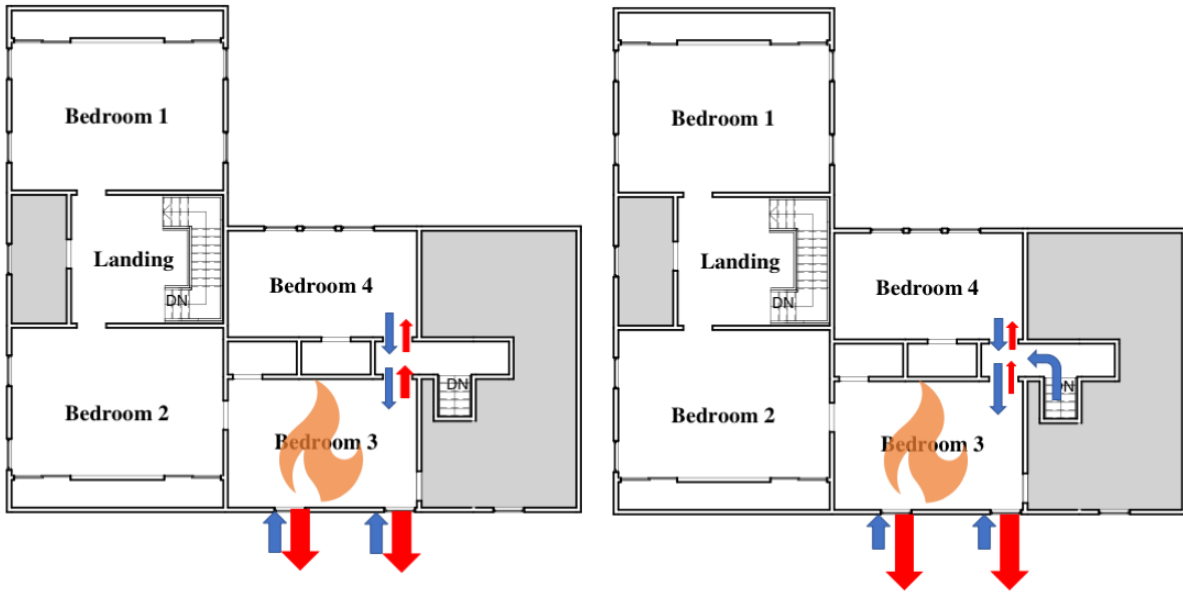

(a) Prior to Front Door Opened

(b) After Front Door Opened

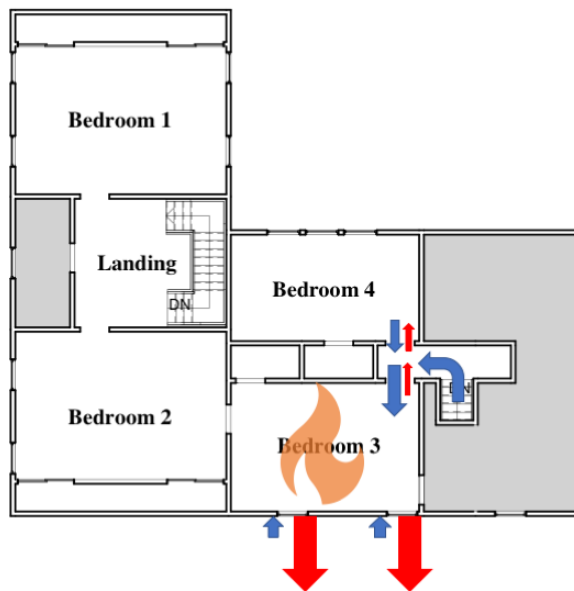

(c) Flows After PPV

Figure 3.59: Changes in flow during Experiment 5. Red arrows indicate the flow of combustion products, blue arrows indicate the flow of fresh air, and the sizes of the arrows indicate the relative magnitude of the flow.

Gas concentrations were measured at the same locations and elevations as heat flux, as shown in Figure 3.60. The gas concentrations at 1 ft and 3 ft in the landing (see Figure 3.60a) first began to change before flashover in the fire room, when visibility conditions in the hallway began to deteriorate. As the second-floor was filled with products of combustion, the O_2 concentration

rapidly decreased and the CO₂ and CO concentrations rapidly increased. The O₂ concentration at the 3 ft level fell to 5.0%, corresponding to the loss of visibility in the hallway camera 285 s into the experiment. The O₂ concentrations at this elevation remained steady through the opening of the front door. The O₂ concentration at the 1 ft level dropped after flashover and continued to gradually decrease and reached a minimum value of 12.4% at the time the front door was opened. The CO₂ concentration at the 3 ft level exceeded the upper limit of the analyzer (measurement limit was 25%), while the concentration at the 1 ft elevation reached a peak of 11.8%. The CO concentrations prior to fire department intervention were steady at 2.6 and 1.3% at the 3 ft and 1 ft elevations, respectively. A reason for the comparatively low O₂ concentrations and high CO₂ and CO concentrations in this experiment was because of the relatively small landing, offset stairs, and direct alignment of bedroom 4 to the fire room, which resulted in rapid filling with products of combustion.

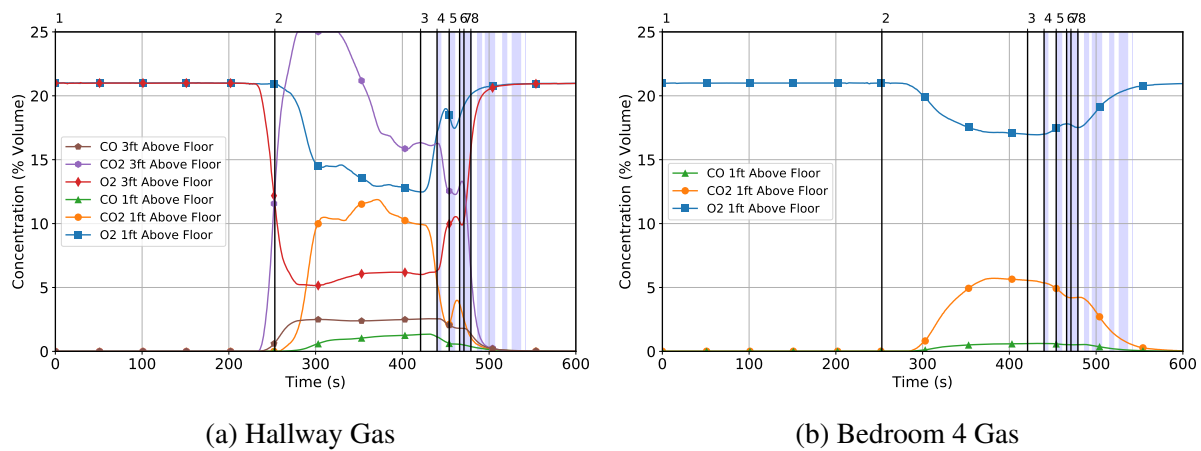

Action/Event	Time (s)
1 Ignition	0
2 Flashover	253
3 Front Door Open	421
4 Flow from Stairs	440
5 Flow from Landing	454
6 Flow from Fire Room Doorway	466
7 Suppression Crew Entered Fire Room	471
8 PPV Fan Turned In	479

Figure 3.60: Gas concentrations in the hallway and bedroom 4 for Experiment 5. Blue vertical bars indicate time and duration of water flow.

In bedroom 4, the O₂ concentration began to decrease and the CO₂ and CO concentrations began to decrease 275 s post ignition. When the front door was opened, the gas concentrations 1 ft above the floor in bedroom 4 were steady, with O₂, CO₂ and CO values of 17.0%, 5.6%, and 0.6%, respectively. The gas concentrations began to trend to ambient after the initial suppression action from the stairway. After the PPV began, gas concentration again began to trend toward ambient. The CO concentrations 1 ft above the floor in bedroom 4 took longer than the same elevation in

the hallway to decrease below 1.2%. This is because the door was the only avenue through which gases could flow in or out.

3.6 Experiment 6 — Interior Suppression with Door Control

Experiment 6 examined interior suppression coordinated with door control on the front door. At 1030 Hilltop Road in Xenia, Ohio, a two-story, 2,200 sq ft wood frame structure was instrumented to conduct this second-floor bedroom fire experiment. The four exterior sides of the structure appear in Figure 3.61. The structure was stick-built with rough cut lumber framing with wood-slat siding. The foundation was a combination of block and stone. The original house had a hip-style tin roof supported by wood members and the rear addition had a peaked roof constructed using 1 in.-by-6 in. sheathing covered with asphalt shingles. Detailed dimensioned drawings for the first and second story appear in Appendix Figures B.12 and B.13, respectively.



Figure 3.61: Exterior photographs of the structure for Experiment 6.

The first-floor had a kitchen, dining room, family room, and flex space. The second-floor had three bedrooms and a second flex space. The stairwell located on side A connected the two floors. These areas defined the experimental volume of the structure. The space located in the A/D corner (adjacent to the living room) and in the B/C corner were isolated and utilized as instrumentation space. The structure was instrumented for temperature, pressure, heat flux, IR, and standard video to capture the fire dynamics during experimentation. Instrumentation was also installed to charac-

terize the potential for skin burns and occupant toxic exposure during the experiment. Figure 3.101 shows the layout of the first and second-floors with the instrumentation locations.



Figure 3.62: Instrumentation and floor plan for Experiment 6. The gray areas were isolated from the remainder of the structure and utilized as space for instrumentation.

Bedroom 1, the fire room, was furnished with the bedroom fuel package described in section 2.4.1. Photographs of the fire room prior to ignition are presented in Figure 3.63. A dimensioned layout of the fire room is included in Figure 3.64. To replicate a similar volume of space found in other experiments, bedroom 2 and bedroom 3 remained closed throughout the experiment. To allow for repeatable fire growth, the windows labeled 18 and 19 in Figure 3.64 were removed prior to ignition.



(a) A/B Corner



(b) B/C Corner



(c) A/D Corner

Figure 3.63: Interior photographs of fire room for Experiment 6.

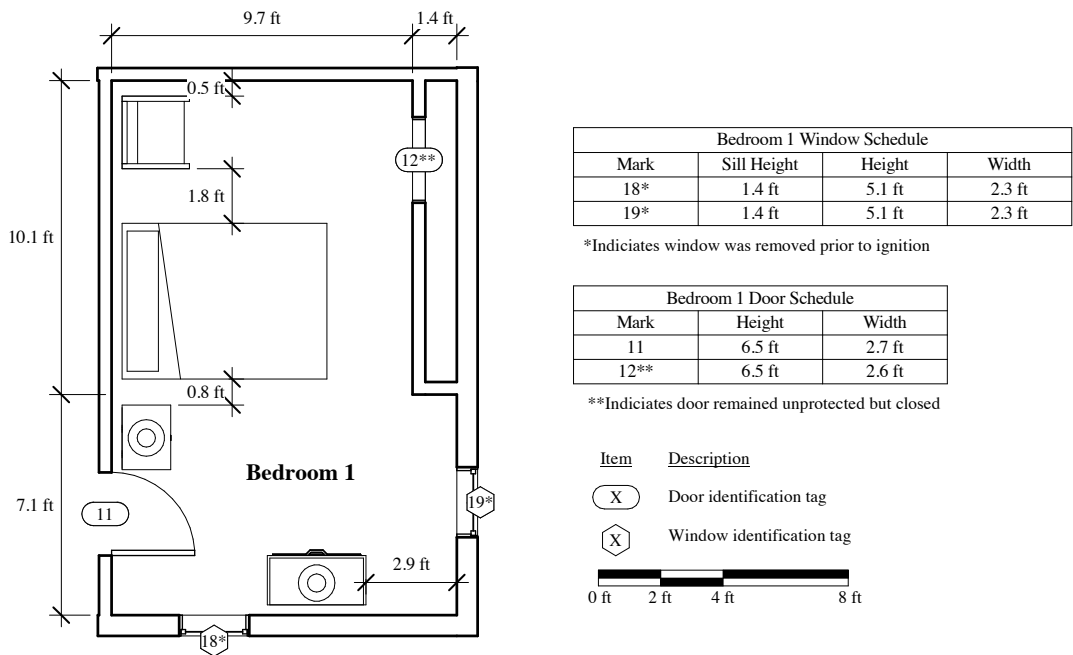
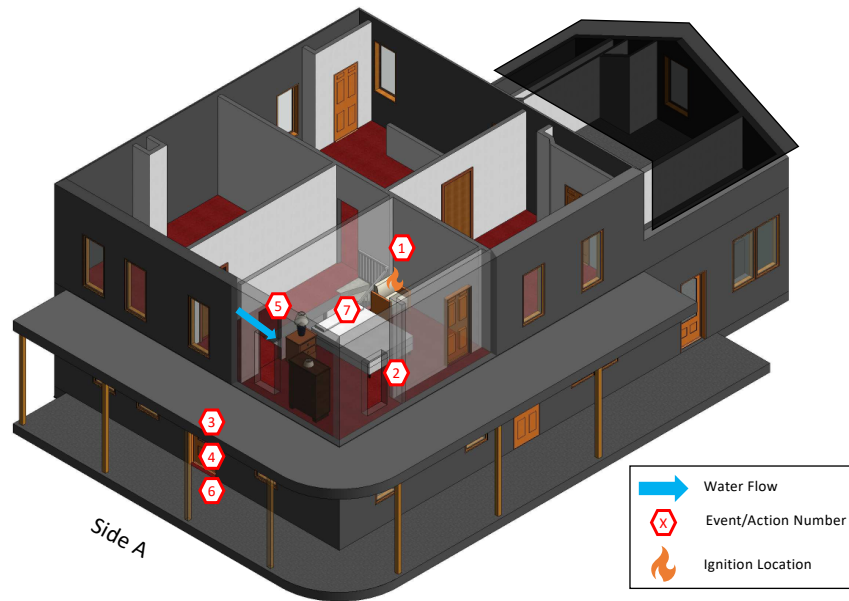

Figure 3.64: Fire room layout for Experiment 6.

The fire was ignited in the corner of the upholstered chair next to the bed ($t = 0$ s). Heavy smoke was observed from the windows 265 s (4:25) post ignition. The fire room transitioned through flashover approximately 329 s (5:29) post ignition. After flashover, smoke from the windows transitioned to flames approximately 360 s (6:00) post ignition. By this time, the smoke layer in the hallway had banked down to the floor. Flames were never observed from the fire room doorway. The fire remained in a post-flashover state through the initial fire department intervention.

The fire department began interventions with opening the front door at 511 s (8:31) post ignition. The suppression crew entered the structure and began to advance up the stairway at 521 s (8:41) post ignition. The crew applied water from the fire room doorway 549 s (9:09) with a 1.75 in. hoseline with a combination nozzle set to straight stream for 16 s. 10 s after the suppression crew entered the structure, the door was closed to the width of the hoseline. As suppression took effect on the fire, the front door was reopened and chocked for the remainder of the experiment 575 s (9:35) post ignition. The suppression crew entered the fire room to conduct final extinguishment at 580 s (9:40) post ignition. Two additional water applications for 12 s and 20 s were used to extinguish the fire.

The total tactic time from front door open to suppression was 69 s (1:09). The total water used for initial suppression was 97 gal, which does not include the water flowed during mop-up operations. The events and actions for Experiment 6 are listed in Figure 3.65, along with their locations imposed on an isometric view of the structure.



Action/Event	Time (mm:ss)	Time (s)
1 Ignition	00:00	0
2 Flashover	05:29	329
3 Front Door Open	08:31	511
4 Suppression Crew Entered, Door Controlled	08:41	521
5 Flow from Fire Room Doorway	09:09	549
6 Front Door Chocked Open	09:35	575
7 Suppression Crew Entered Fire Room	09:40	580

Figure 3.65: Time and sequence of actions and events for Experiment 6.

Temperatures closest to the ceiling (6 ft and above) in the fire room began to increase approximately 50 s post ignition. All elevations experienced an increase in temperature by 250 s post ignition. At approximately 329 s post ignition, the fire room reached flashover as all fire room temperatures increased beyond 1100 °F. Temperatures post-flashover decreased and remained steady. Approximately 40 s after the front door was opened and controlled, a brief increase in fire room temperatures was observed, prior to the initial suppression action from the fire room doorway (Action 5). This initial suppression effectively reduced temperatures in the fire room, and subsequent suppression actions in the fire room itself further reduced temperatures.

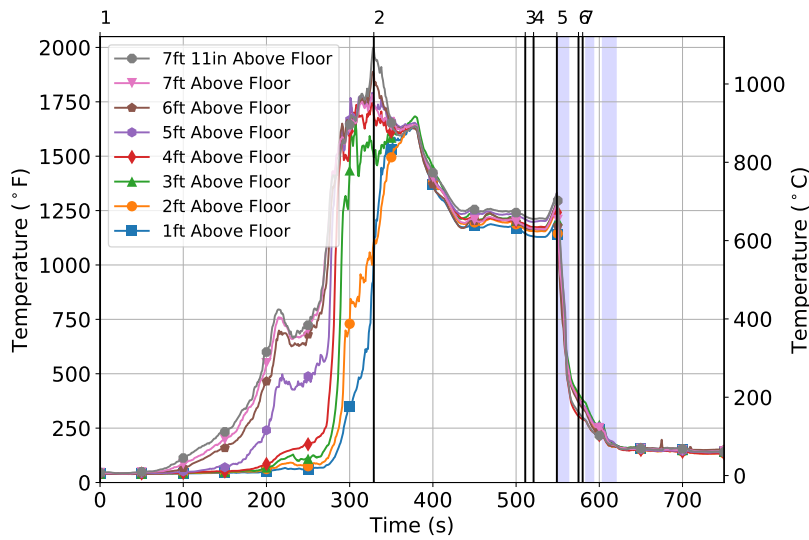

	Action/Event	Time (s)
1	Ignition	0
2	Flashover	329
3	Front Door Open	511
4	Suppression Crew Entered, Door Controlled	521
5	Flow from Fire Room Doorway	549
6	Front Door Chocked Open	575
7	Suppression Crew Entered Fire Room	580

Figure 3.66: Fire room (bedroom 1) temperatures for Experiment 6. Blue vertical bars indicate time and duration of water flow.

The hallway temperatures followed a similar trend in the pre-intervention period to the fire room temperatures, as shown in Figure 3.67a, with a brief pause in the fire growth approximately 220 s post ignition. Peak ceiling temperatures were observed shortly before the fire room transitioned through flashover. Temperatures then decreased to a steady value which was maintained until the time of fire department intervention. The temperatures at the time of fire department intervention ranged from 935 °F close to the ceiling to 60 °F 1 ft above the floor. Temperatures at the 1 ft elevation are indicative of the air temperatures in remote locations throughout the structure, suggesting air was entrained into the fire room at this elevation. After the front door was opened, the hallway temperatures above 1 ft slightly decreased at all levels, before a more rapid decrease occurred. The rapid decrease corresponded with the initial suppression action from the fire room doorway. As suppression continued, temperatures continued to decrease, dropping below 300 °F 160 s after the front door was opened.

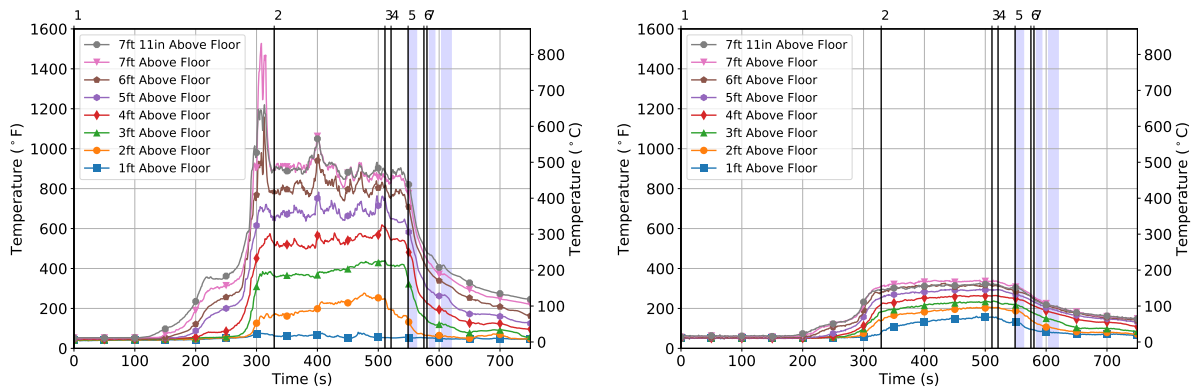

(a) Hallway Temperatures

(b) Flex Space Temperatures

	Action/Event	Time (s)
1	Ignition	0
2	Flashover	329
3	Front Door Open	511
4	Suppression Crew Entered, Door Controlled	521
5	Flow from Fire Room Doorway	549
6	Front Door Chocked Open	575
7	Suppression Crew Entered Fire Room	580

Figure 3.67: Second-floor temperatures for Experiment 6. Blue vertical bars indicate time and duration of water flow.

The temperatures in the flex space did not increase as much as at the hallway because the flex space was more remote from the fire room. The post-flashover period reached steady values between 335 °F close to the ceiling and 155 °F 1 ft above the floor. The temperatures in the flex space began to decrease after the front door was opened and controlled, and continued to decrease as suppression was initiated. The flex space temperatures decreased below 200 °F at all elevations 100 s after the front door was opened.

The low temperatures measured 1 ft above the floor in the hallway were mirrored by the heat flux at that location (see Figure 3.68b). The heat flux was negligible during the initial growth period, reaching a brief peak of 2.8 kW/m², 300 s post ignition, shortly before the time of flashover. The heat flux then decreased to below 1 kW/m² for the remainder of the experiment. One reason this low heat flux occurred directly outside the fire room doorway is that the gauge was located directly in the path of fresh air being entrained into the fire room. Because the seat of the fire was located in the corner of bedroom 1, away from the doorway, there were no flames rolling out of the fire room doorway over the heat flux gauge, as was observed in other experiments.

The heat flux values 1 ft and 3 ft above the floor in the flex space began to increase at the same time as the heat flux in the hallway—shortly before flashover in the fire room. Because these gauges were not exposed to a constant flow of cool air, they increased during the post-flashover period to values of 3.5 kW/m² and 1.4 kW/m² at 3 ft and 1 ft, respectively. Like the flex space temperatures, the flex space heat fluxes began to decrease after the front door was opened, and continued to decrease as suppression was conducted. The heat flux at both elevations in the flex space decreased to background levels approximately 650 s post ignition.

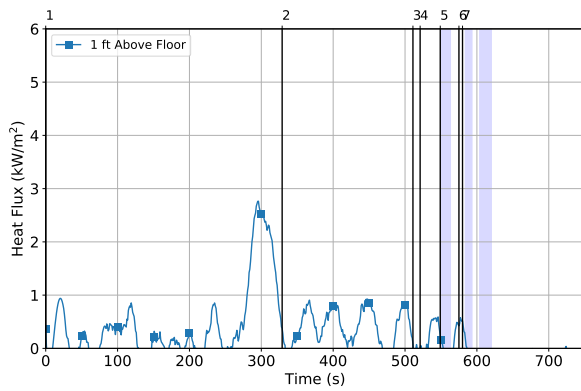

(a) Hallway Heat Flux

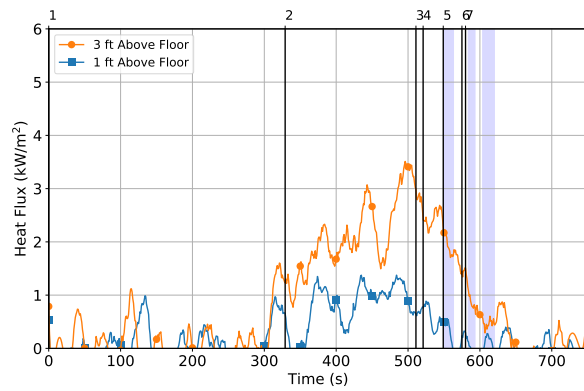

(b) Flex Space Heat Flux

	Action/Event	Time (s)
1	Ignition	0
2	Flashover	329
3	Front Door Open	511
4	Suppression Crew Entered, Door Controlled	521
5	Flow from Fire Room Doorway	549
6	Front Door Chocked Open	575
7	Suppression Crew Entered Fire Room	580

Figure 3.68: Heat flux for Experiment 6. Blue vertical bars indicate time and duration of water flow.

The growth trend observed in the fire room temperatures was mirrored in the behavior of the fire room pressures (shown in Figure 3.69a). The 7 ft pressure in the fire room first started to increase approximately 100 s post ignition, as the smoke layer in the fire room started to develop. The pressure increased until 210 s post ignition, briefly stabilized, and continued to increase, reaching a peak 13.0 Pa. As the smoke layer continued to bank down in the fire room, the 4 ft pressure increased and the 1 ft pressure decreased below 0 Pa, indicating a bi-directional flow was established through the fire room vents. This pressure profile was maintained through the time of fire department intervention. The pressures were not drastically affected by the opening of the front door, but started to converge to 0 Pa as suppression began. In particular, the 7 ft pressure in the fire room decreased significantly during water application from the fire room doorway (Action 5).

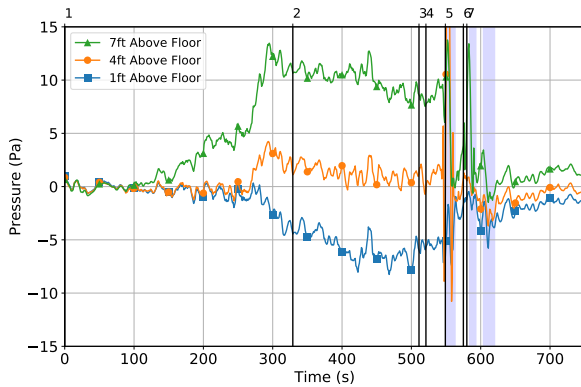

(a) Bedroom 1 Pressure

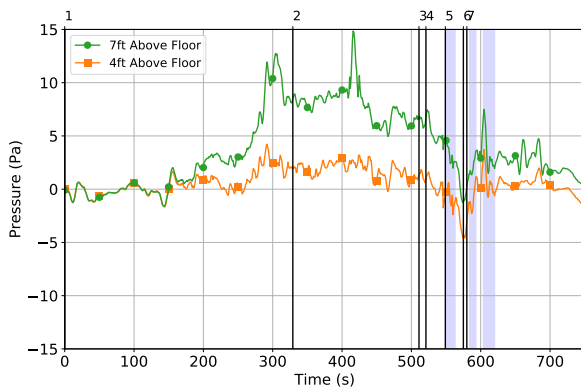

(b) Hallway Pressure

	Action/Event	Time (s)
1	Ignition	0
2	Flashover	329
3	Front Door Open	511
4	Suppression Crew Entered, Door Controlled	521
5	Flow from Fire Room Doorway	549
6	Front Door Chocked Open	575
7	Suppression Crew Entered Fire Room	580

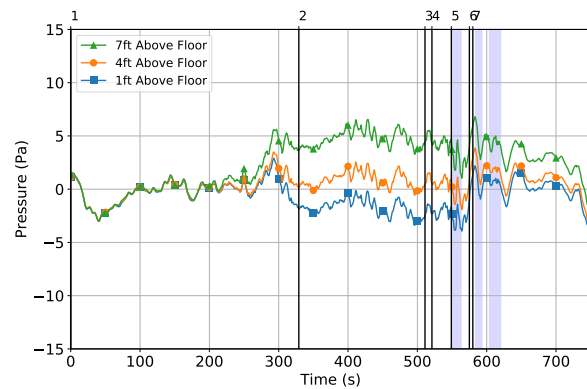

(c) Flex Space Pressure

Figure 3.69: Second-floor pressure for Experiment 6. Blue vertical bars indicate time and duration of water flow.

Note: The 1 ft pressure in the hallway was damaged prior to the start of the experiment. The 4 ft and 7 ft pressures at this location followed a similar trend to the fire room, although the magnitude of the pressures were less. After the front door was opened, the 4 ft and 7 ft pressures both began to decrease, and continued to decrease through the initial suppression action (Action 5) to 0 Pa and -3.0 Pa at 7 ft and 4 ft, respectively. This may be a result of gas contraction from suppression.

The pressures in the flex space had the lowest magnitude of the open spaces on the second-floor and did not start to change until approximately 20 s post ignition. As the fire reached flashover in bedroom 1, all three pressures were increasing. The 1 ft pressure decreased below 0 Pa 300 s post ignition, at approximately the same time visibility in the flex space was reduced. This pressure profile was maintained through the front door opening, only beginning to decrease once the suppression crew began flowing water from the fire room doorway. This decrease in pressure at all three elevations mirrored the decrease in the flex space.

The changes in flow during the experiment are illustrated in Figure 3.70. As the fire grew to a point where it became ventilation limited, bi-directional flow paths were created in the fire room windows, entraining fresh air into the fire room and exhausting hot gases out of the fire room and the fire room doorway, drawing fresh air from remote parts of the structure to the fire room and replacing it with products of combustion, as shown in Figure 3.70a. The opening of the front door created a more efficient flow path, allowing fresh air to flow into the structure through the front door and travel up the stairs and into the fire room, while hot gases still exhausted from the upper portion of the fire room windows and doorway, as shown in Figure 3.70b. After the suppression crew entered, the front door was closed, reducing the amount of air entrained into the fire room (indicated by the smaller blue arrow in Figure 3.70c). Although the door was closed, the entrained air did result in an increase in fire room temperature and pressure, indicating the fire grew despite the door control action, although the suppression actions in the fire room doorway and fire room interior prevented this fire growth from increasing temperatures or gas concentrations elsewhere in the structure.

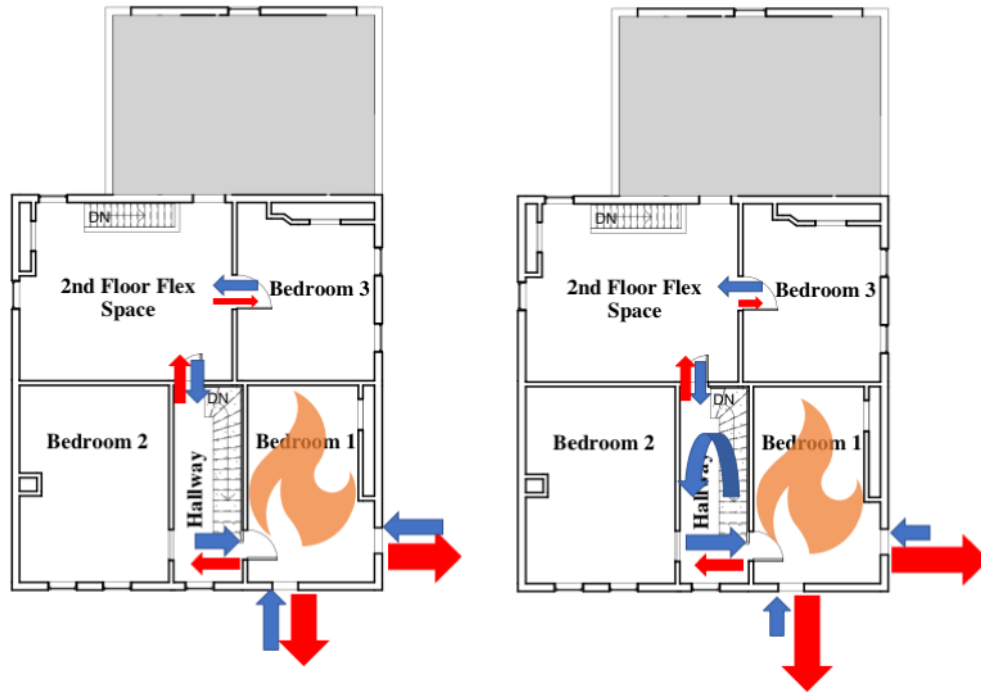

(a) Prior to Front Door Opened

(b) After Front Door Opened

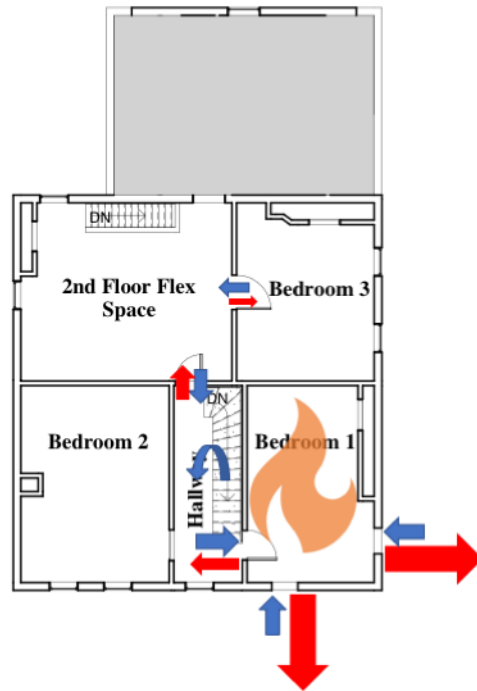

(c) After Door Control

Figure 3.70: Changes in flow during Experiment 6. Red arrows indicate the flow of combustion products, blue arrows indicate the flow of fresh air, and the sizes of the arrows indicate the relative magnitude of the flow.

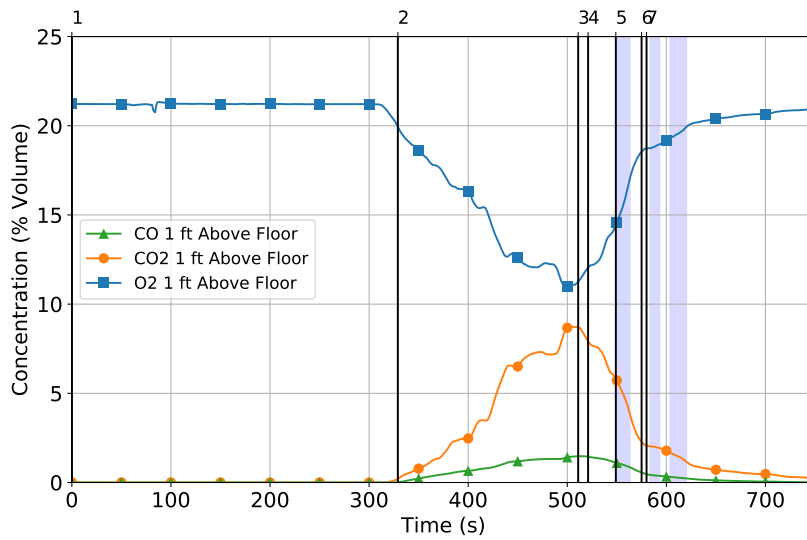

	Action/Event	Time (s)
1	Ignition	0
2	Flashover	329
3	Front Door Open	511
4	Suppression Crew Entered, Door Controlled	521
5	Flow from Fire Room Doorway	549
6	Front Door Chocked Open	575
7	Suppression Crew Entered Fire Room	580

Figure 3.71: Flex space gas concentrations for Experiment 6. Blue vertical bars indicate time and duration of water flow.

Gas concentrations were measured in three locations throughout the second-floor: 1 ft and 3 ft above the floor in the flex space, and 1 ft above the floor in the hallway. Because of the flow of fresh air into the fire room over the course of the experiment mentioned in previous paragraphs, the gas concentrations at the 1 ft level in the stairway remained close to ambient for the duration of the experiment.

In the flex space, there was an error with the 3 ft gas analyzer, so only the 1 ft data is displayed in Figure 3.71. All gases first started to decrease shortly before the fire room transitioned through flashover, shortly after visibility was lost at this location 290 s post ignition. All gases continued to decrease until the front door was opened, reaching values of 11.0%, 9.0%, and 1.5% for O₂, CO₂, and CO, respectively. The opening of the front door caused 1 ft gas concentrations to decrease, although the door was closed to the width of the hoseline, the entrained air had a positive impact on gas concentrations close to the floor in the flex space.

Bedroom Fires Method 2

3.7 Experiment 7 — Interior Suppression Following Vertical Ventilation

Experiment 7 was designed to evaluate vertical ventilation prior to suppression with the ventilation location over the fire room. At 201/203 Water Street in Sidney, Ohio, a two-story, 3,074 sq ft wood frame structure was instrumented to conduct this second-floor bedroom fire experiment. The four exterior sides of the structure appear in Figure 3.72. The structure was built with rough cut lumber framing with wood-slat siding. The foundation was a mix of poured concrete and concrete block. The hip-style roof was constructed using 1 in.-by-6 in. sheathing covered with asphalt shingles. Interior walls were finished with plaster and lath while interior floors included carpet in both bedrooms and wood on the steps and landing. Detailed dimensioned drawings for the first and second story appear in Appendix Figures B.1 and B.2, respectively.



Figure 3.72: Exterior photographs of the structure for Experiment 7.

Originally a single-family home, the building was last used as multiple tenant spaces with two apartments on the first-floor and two on the second-floor. The second-floor apartments were re-configured for the experiment as two bedrooms with a common access stairway. These areas, accounting for 584 sq ft, defined the experimental volume of the structure; all other areas within the structure were isolated and used to protect instrumentation from products of combustion. The structure was instrumented for temperature, pressure, heat flux, IR, and standard video to capture the fire dynamics during experimentation. Instrumentation was also installed to characterize the potential for skin burns and occupant toxic exposure during the experiment. Figure 3.73 shows the layout of the first and second-floors with the instrumentation locations.

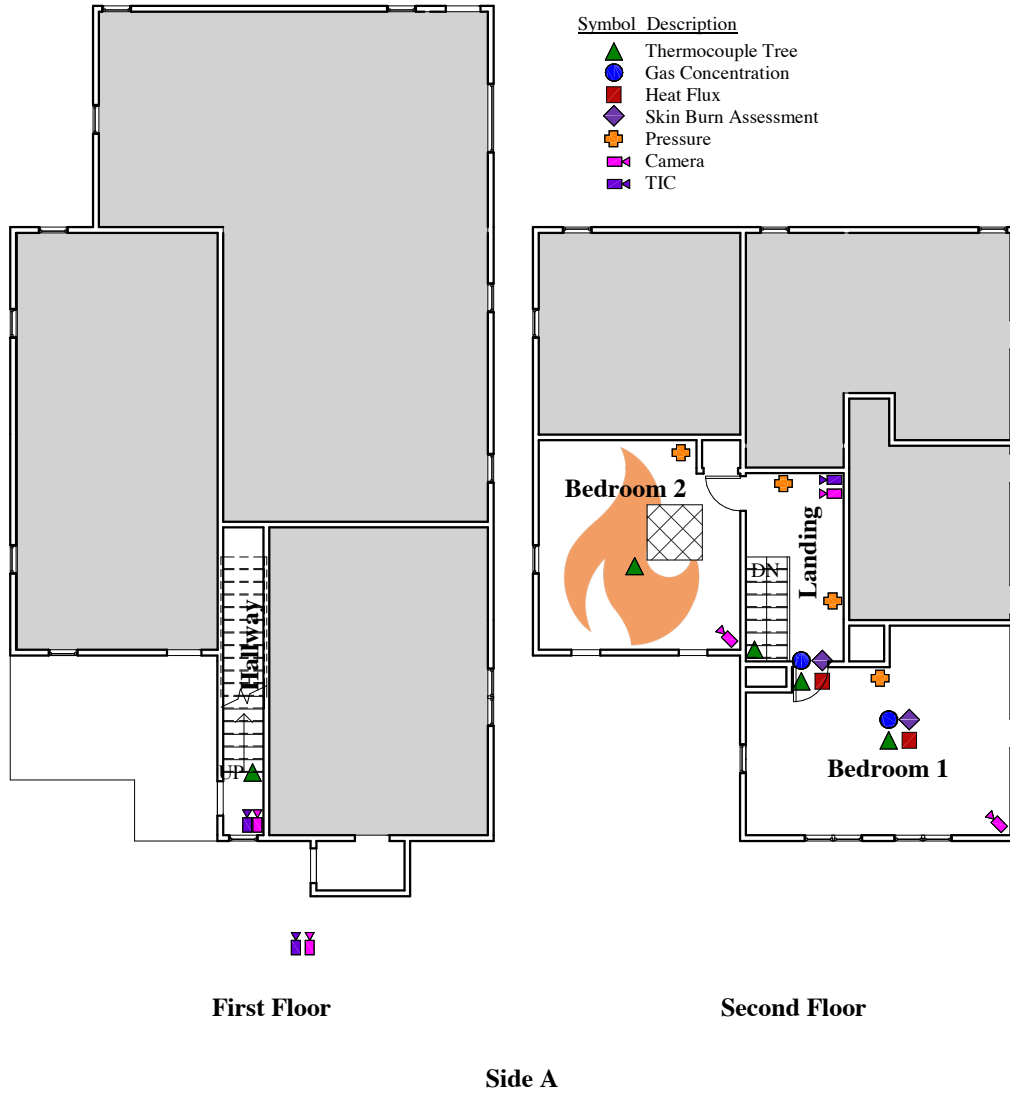

Figure 3.73: Instrumentation and floor plan for Experiment 7. The gray areas were isolated from the remainder of the structure and utilized as space for instrumentation. The cross-hatched area indicates the size and location of the vertical vent. Not shown on this plan was an additional thermocouple array located in the attic.

Bedroom 2 was furnished with the bedroom fuel package described in Section 2.4.1. Photographs of the fire room prior to ignition are presented in Figure 3.74. A dimensioned layout of the fire room is included in Figure 3.75.



(a) Side A

(b) Side B



(c) Doorway

Figure 3.74: Interior photographs of fire room for Experiment 7.

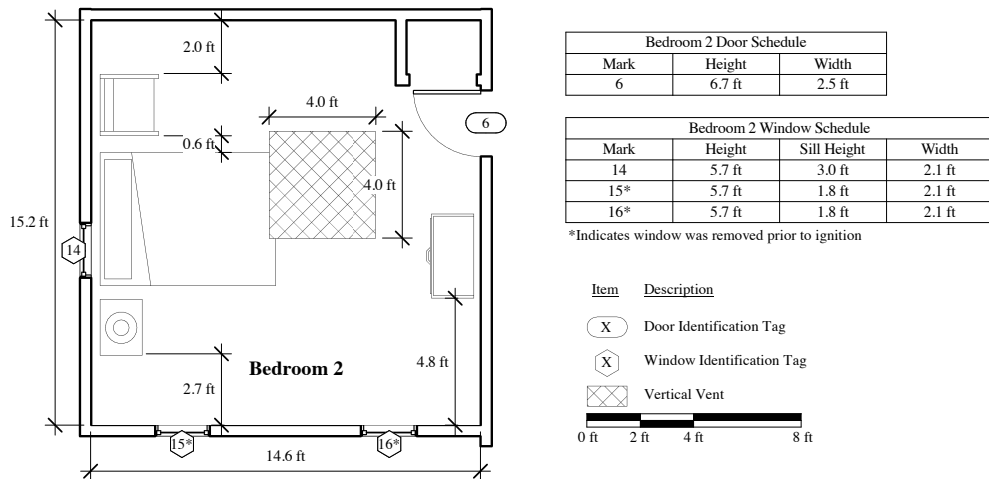

Figure 3.75: Fire room layout for Experiment 7. The cross-hatched box indicates the size and location of the vertical vent.

A 4 ft-by-4 ft ventilation opening was located over bedroom 2. A roof hole and a ceiling hole located directly below the roof hole were cut prior to ignition. The roof hole was covered by plywood and sealed to prevent leakage. The ceiling hole was covered with half-inch gypsum board. Vertical ventilation was completed by first removing the plywood to expose the precut roof hole, replicating a crew cutting a ventilation hole. Immediately following, the interior gypsum was released, exposing the precut ceiling hole and replicating a crew removing the compartment ceiling. Figure 3.76 shows the covered precut roof opening and the interior hinged ceiling.



(a) Roof Vent



(b) Interior Ceiling

Figure 3.76: Vertical ventilation openings for Experiment 7.

The fire was ignited in the corner of the upholstered chair. Fire was first visible from the side A windows at 283 s (4:43) post ignition and fire was continuous at both windows 10 s later. The fire room transitioned through flashover at 296 s (4:56) post ignition. Interior fire room conditions reached steady state before fire department interventions occurred.

The front door was opened 430 s (7:10) post ignition. Vertical ventilation was considered complete when the interior ceiling covering was released 442 s (7:22) post ignition. Just after vertical ventilation was completed, the side B window failed causing visible flames from the window at 448 s (7:28) post ignition. The suppression crew advanced a 1.75 in. hoseline with a combination nozzle set to straight stream into the structure through the front door. Approximately 2/3 up the stairwell, the crew flowed water for 3 s, 456 s (7:36) post ignition. After reaching the top of the stairs the crew flowed water from the doorway into the fire room for 17 s at 472 s (7:52) post ignition. Once the nozzle firefighter determined the fire room was cooled sufficiently, the crew entered the fire room at 503 s (8:30). Final suppression occurred at 515 s (8:35) post ignition for a duration of 10 s.

The entire tactic from front door open to occupying the fire room was 80 s (1:20). The total water flowed for initial suppression was approximately 133 gal. This does not include the water flowed during mop-up operations. Figure 3.77 shows the sequence of events with an isometric image of the structure.

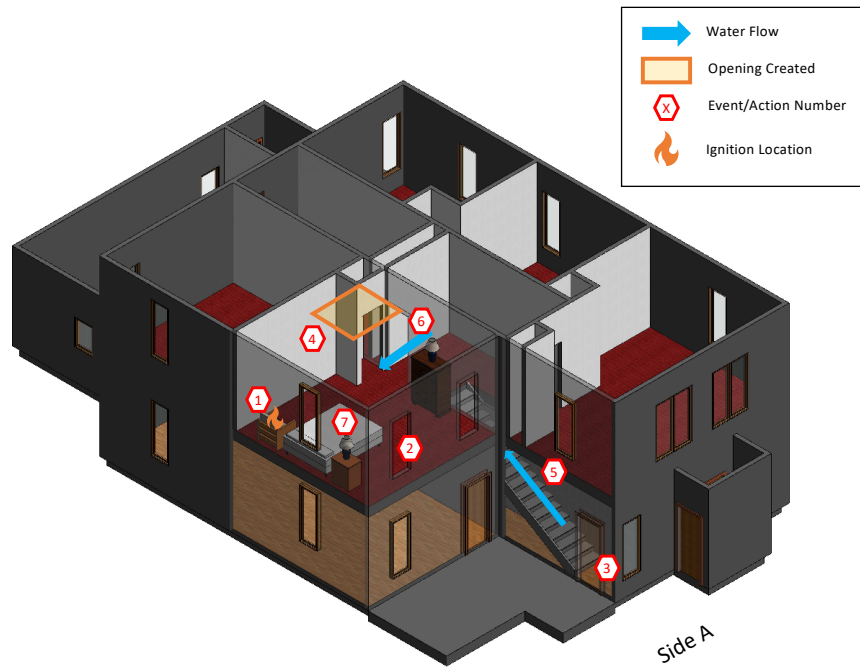

Action/Event	Time (mm:ss)	Time (s)
1 Ignition	00:00	0
2 Flashover	04:56	296
3 Front Door Open	07:10	430
4 Vertical Vent Completed	07:22	442
5 Flow from Stairs	07:36	456
6 Flow from Fire Room Doorway	07:52	472
7 Suppression Crew Entered Fire Room	08:30	510

Figure 3.77: Time and sequence of actions and events for Experiment 7.

Figure 3.78 shows the time history of the measured temperature variations in the fire room. Thermocouples first measured a temperature increase at approximately 80 s post ignition. As the fire room transitioned through flashover, temperatures in the fire room exceeded the listed calibration of the thermocouple wire used for these experiments. This introduced an increased uncertainty (above the typical $\pm 15\%$) in the accuracy of the measurements for the duration of the experiment. The fire room remained in a post-flashover state until firefighters initiated suppression. Following the front door opening and the vertical ventilation sequence, temperatures increased in the fire room. The open front door allowed fresh air to be entrained into the structure while the open roof hole allowed hot gases to exhaust from the structure, increasing fire growth. Temperatures began to drop following hallway suppression, but the most significant impact occurred when the nozzle firefighter began suppression from the fire room doorway.

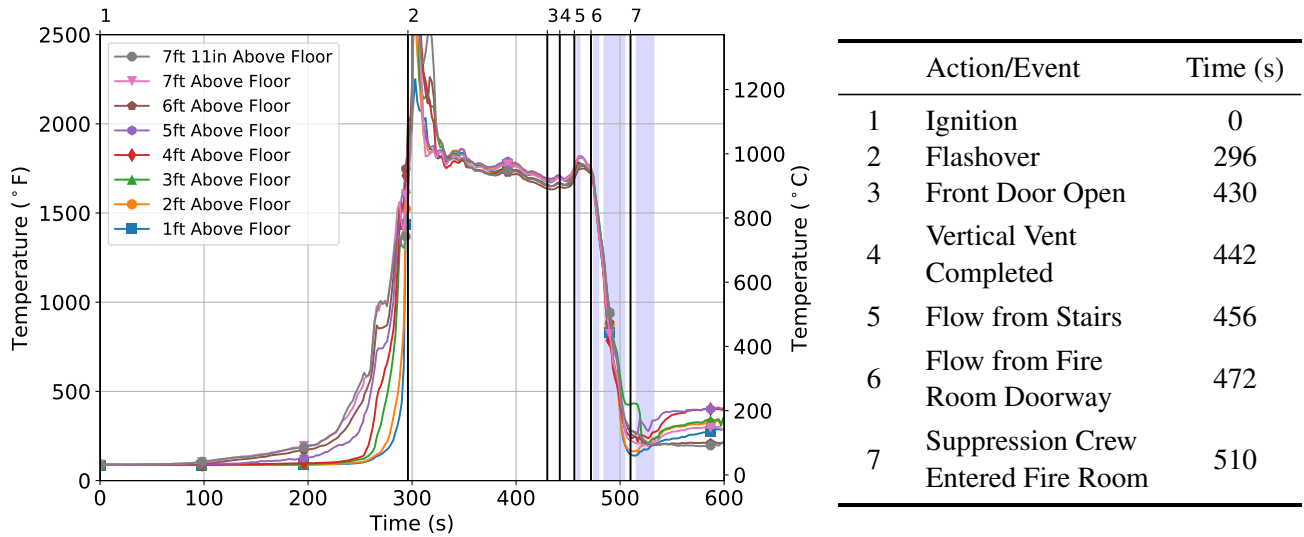

Figure 3.78: Temperatures in fire room (bedroom 2) for Experiment 7. Blue vertical bars indicate time and duration of water flow.

Figure 3.79 shows the temperatures measured by the thermocouple array located in the center of the attic space of the structure. Attic temperatures first started to increase as the fire room transitioned through flashover. Flames and combustion gases venting from the bedroom 2 windows impinged on the soffit, traveling through the soffit vents into the attic space. The measured peak attic temperature prior to fire department intervention was 535 °F at 7 ft above the floor. After vertical ventilation was completed, hot gases from the post-flashover fire were able to exhaust into the attic space. The peak temperature exceeded 1000 °F. Temperatures significantly decreased once the suppression crew began flowing water from the fire room doorway.

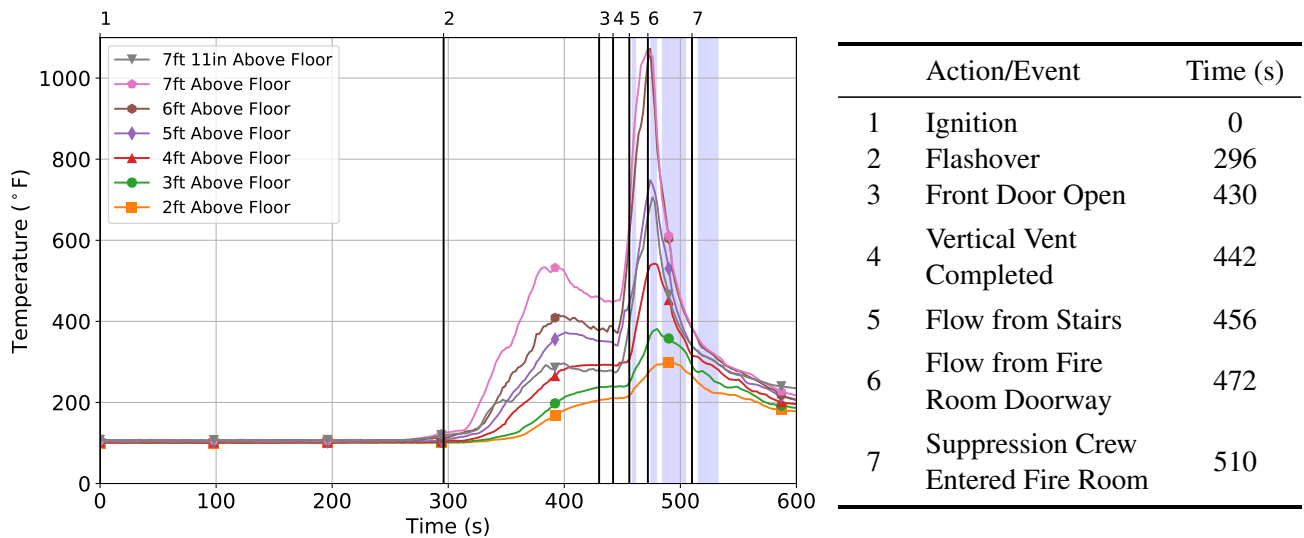
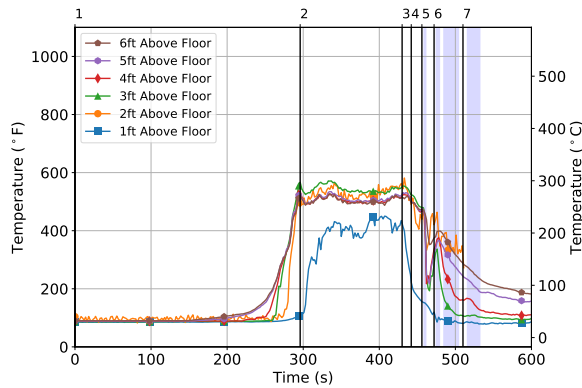

Figure 3.79: Temperatures in attic for Experiment 7. Blue vertical bars indicate time and duration of water flow.

While the combination of the open front door and vertical vent led to an increase in fire room and attic temperatures, temperatures generally decreased in the open spaces throughout the second-floor over the 2 min. following initial firefighter intervention (see Figure 3.80). Landing temperatures were steady prior to the front door opened, as shown in Figure 3.80a. Above the 2 ft elevation, the temperatures were between 500 °F and 565 °F. After ventilation was complete, temperatures began to decrease. The initial suppression from the stairway reduced temperatures. At 3 ft and above, temperatures increased after water flow stopped as a result of the gases that continued to flow from the fire room until suppression from the fire room doorway.



(a) Landing Temperatures

	Action/Event	Time (s)
1	Ignition	0
2	Flashover	296
3	Front Door Open	430
4	Vertical Vent Completed	442
5	Flow from Stairs	456
6	Flow from Fire Room Doorway	472
7	Suppression Crew Entered Fire Room	510

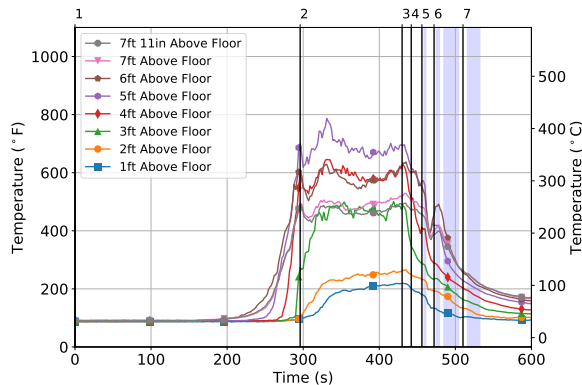

(b) Bedroom 1 Doorway Temperatures

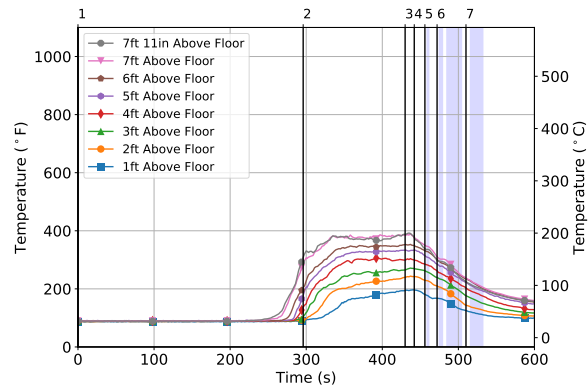

(c) Bedroom 1 Temperatures

Figure 3.80: Temperatures remote from the fire room for Experiment 7. Blue vertical bars indicate time and duration of water flow.

Bedroom 1 doorway temperatures were also steady prior to fire department interventions. The temperature profile at the doorway (seen Figure 3.80b) indicated the hot gas layer was between 2 ft and 3 ft at the time the front door was opened. Following the ventilation sequence, the 1 ft temperature decreased from 220 °F to 180 °F, the 3 ft temperature decreased from 480 °F to 285 °F, and the 5 ft temperature decreased from 700 °F to 575 °F. Stairway suppression reduced temperatures at the 4 ft level and above, but they began to rise again until suppression from the fire room doorway.

Bedroom 1 temperatures at the time of front door opening were steady, ranging between 380 °F near the ceiling and 195 °F 1 ft above the floor (see Figure 3.80c). Following ventilation, temperatures at all elevations of the space began to decrease. The decrease in temperatures was more rapid close to the ceiling. Unlike the landing and remote room doorway temperatures, there were not immediate changes in temperature that corresponded to suppression actions.

The fire behavior in the structure was also reflected by changes in pressure. As the bedroom fire in Experiment 7 grew, bi-directional flows were established at the fire room windows and doorway. The fire room pressure (see Figure 3.81) started to change approximately 200 s post ignition. The 4 ft and 7 ft pressure increased as hot, combustion gases filled the fire room. The 1 ft pressure decreased below ambient pressure, which drew gases toward the fire room. This pressure profile was steady until the front door and vertical vent were opened. These vents resulted in a drop in pressure in the fire room at all three elevations—7.0 Pa, 7.4 Pa, and 8.3 Pa at the 7 ft, 4 ft, and 1 ft levels, respectively. The pressure drop associated with the change in ventilation was temporary as all three elevations showed a pressure rise due to the resulting fire growth. The pressure increase coincided with the temperature rise shown in Figure 3.78, prior to the suppression crew flowing water from the fire room doorway.

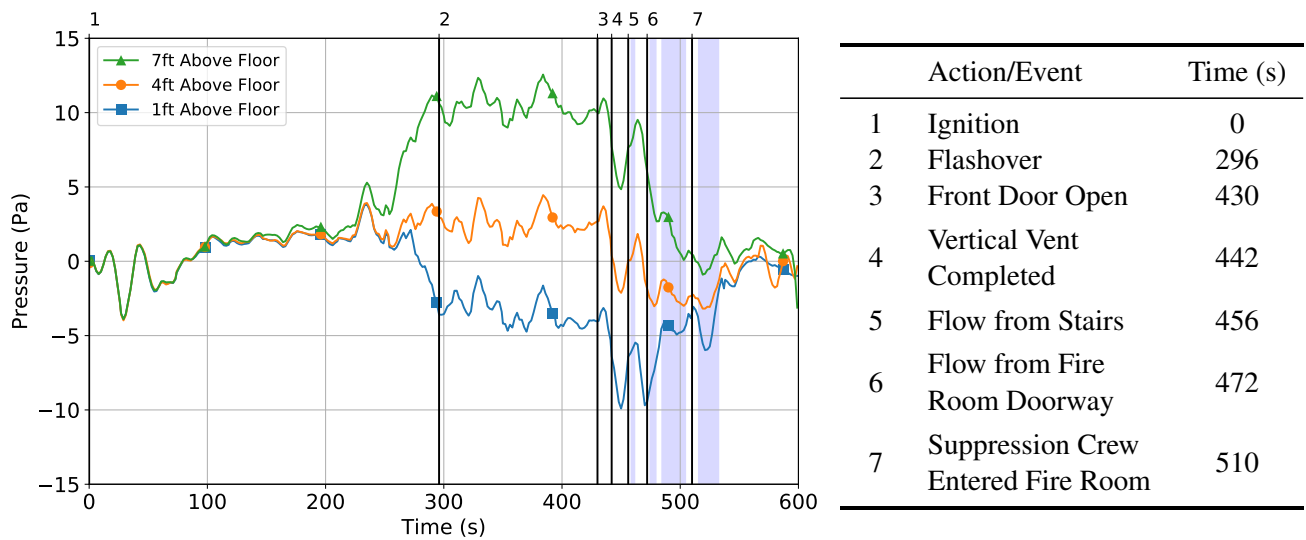
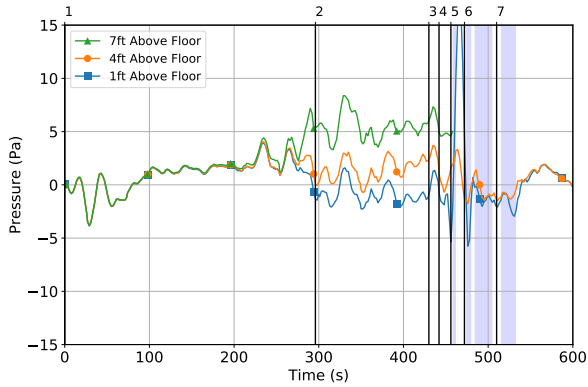

Figure 3.81: Pressures in fire room (bedroom 2) for Experiment 7. Blue vertical bars indicate time and duration of water flow.

Figure 3.82 shows the pressure in the hallway outside the fire room (see Figure 3.82a), in the hallway outside bedroom 1 (see Figure 3.82b), and in bedroom 1 (see Figure 3.82c) for Experiment 7. At each of these locations, the pressures were least close to the floor and greatest at the ceiling. Large pressures indicated hot gases were filling the area near the ceiling. Small pressures indicated fresh air was being entrained out of remote rooms toward the fire room. Because the fire was the source of the pressure increase within the structure, the magnitude of pressure increase decreased with distance from the fire room.



(a) Hallway Pressure

	Action/Event	Time (s)
1	Ignition	0
2	Flashover	296
3	Front Door Open	430
4	Vertical Vent Completed	442
5	Flow from Stairs	456
6	Flow from Fire Room Doorway	472
7	Suppression Crew Entered Fire Room	510

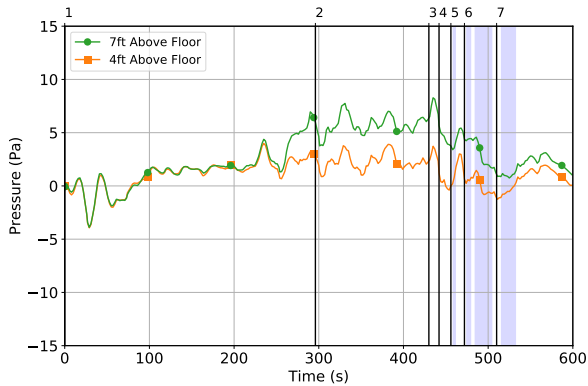

(b) Hallway Pressure Outside Bedroom 1

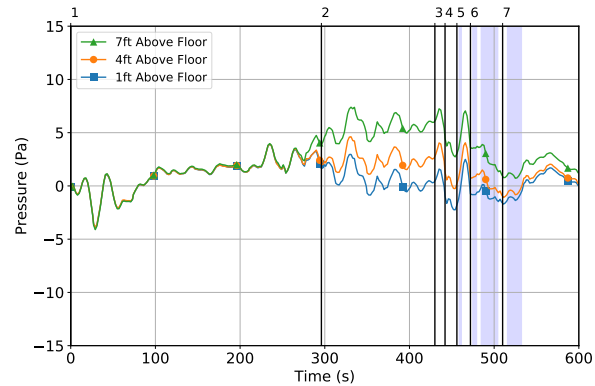

(c) Bedroom 1 Pressure

Figure 3.82: Pressures remote from fire room for Experiment 7. Blue vertical bars indicate time and duration of water flow.

The pressure differences between the fire room and the hallway are useful for describing the changes in gas flow over the course of Experiment 7. Prior to fire department intervention, the 1 ft fire room pressure was less than the 1 ft pressure in the hallway. Similarly, the 7 ft pressure in the fire room was greater than the 7 ft pressure in the hallway outside the fire room. These pressure gradients reflect an exchange of cool air into the fire room through the bottom of the doorway and hot gases out of the fire room through the top of the doorway. The flows prior to fire department intervention are illustrated in Figure 3.83a.

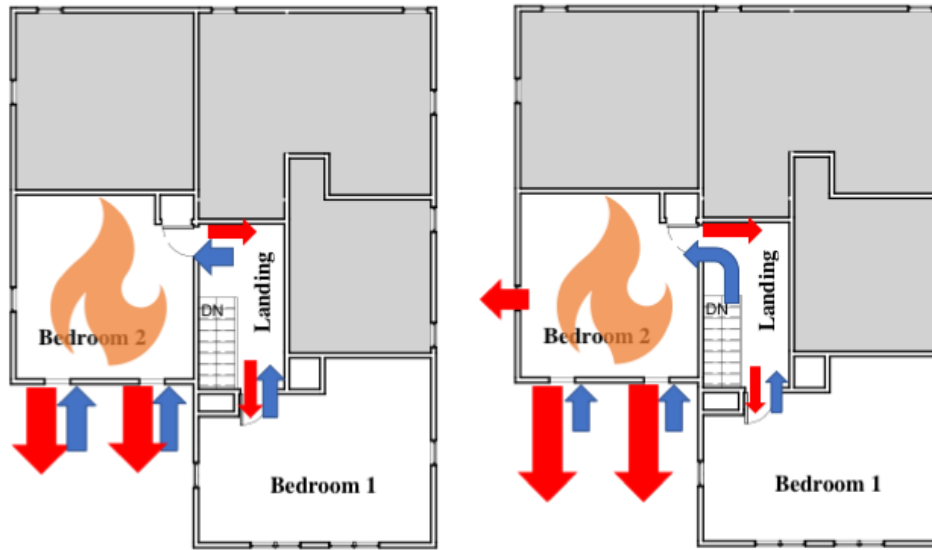

(a) Prior to Front Door Opened

(b) After Front Door Opened

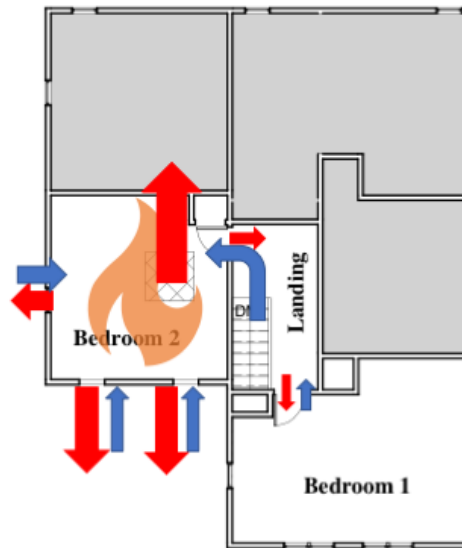

(c) After Vertical Ventilation

Figure 3.83: Changes in flows for Experiment 7 as function of firefighter ventilation. Red arrows indicate the flow of combustion products, blue arrows indicate the flow of fresh air, and the sizes of the arrows indicate the relative magnitude of the flow.

The opening of the front door at 430 s post ignition allowed for additional entrainment of fresh air into the fire room as depicted in Figure 3.83b. When the vertical vent was completed, there was more surface area available for exhaust in the fire room. This provided an additional low-pressure exhaust pathway as shown in Figure 3.83c. Hot gases were able to exhaust from the vertical vent hole and the fire room doorway and windows.

This change in flow was reflected by the increase in the pressure gradient in the period between

when the vertical vent hole was completed and the initial suppression. The increase in flow into the fire room was indicated by the lower fire room pressure compared to the hallway at the 1 ft and 4 ft levels and the decreased gradient at the 7 ft level (see Figure 3.82b). Note: That the short duration spike in pressure at the 1 ft level following the water flow from the stairs is likely from the hose stream hitting the pressure measurement probe.

Heat flux was measured at 1 ft and 5 ft above the floor in the bedroom 1 doorway and 1 ft over the floor in bedroom 1. Figure 3.84 shows the heat flux in the doorway of bedroom 1. The ventilation sequence resulted in a decrease in heat flux at the 1 ft elevation in the doorway from 3.5 kW/m² to 1.0 kW/m². The initial suppression in the stairway further decreased the heat flux from 1.0 kW/m² to 0.5 kW/m² at the 1 ft level. Similarly, at the 5 ft level in the doorway, the heat flux decreased from 12 kW/m² to 6 kW/m². Water application further decreased the heat flux from 6 kW/m² to 3 kW/m². Note: Heat flux in the remote bedroom remained negligible during the experiment.

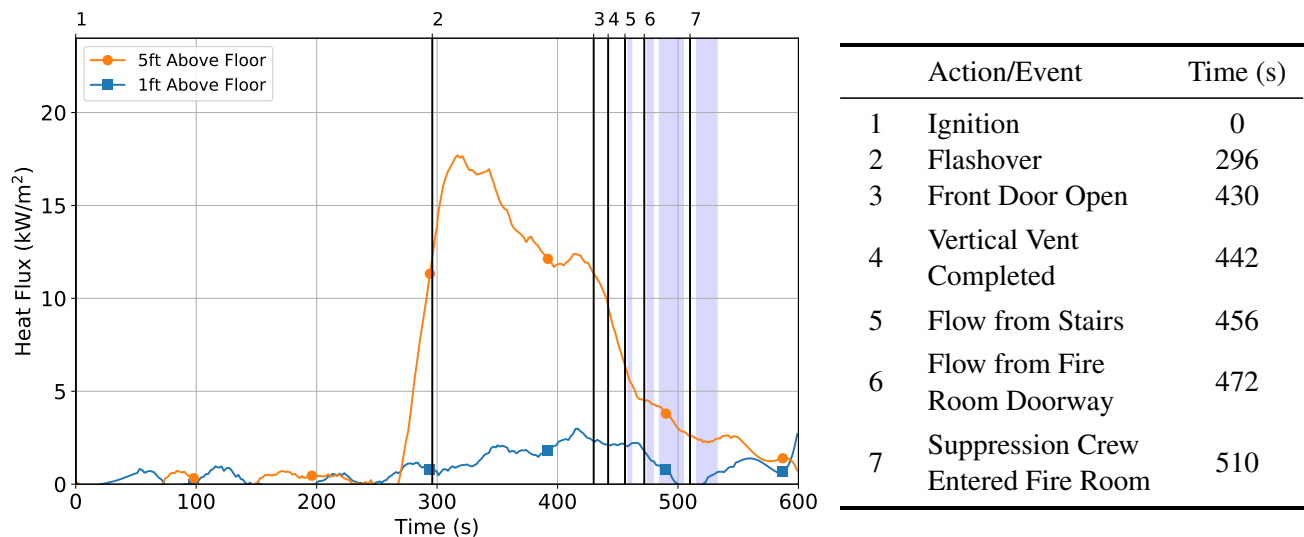
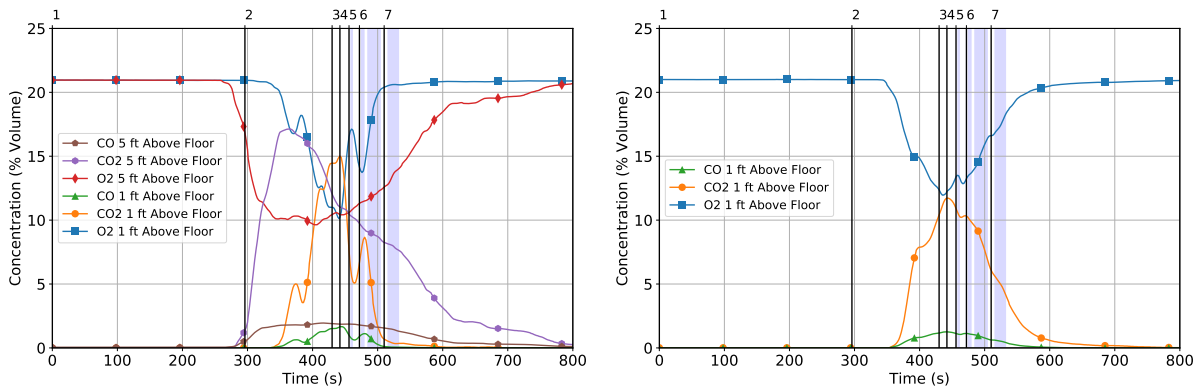

Figure 3.84: Heat flux in the doorway of bedroom 1 for Experiment 7. Blue vertical bars indicate time and duration of water flow.

Figure 3.85 shows the gas concentrations (CO, CO₂, and O₂) measured at 1 ft and 5 ft above the floor in the doorway to bedroom 1 and 1 ft above the floor in bedroom 1. The highest CO and CO₂ concentrations and lowest O₂ concentration of the three locations were measured at the 5 ft location in the doorway (see Figure 3.85a). O₂ concentrations first decreased and CO and CO₂ concentrations correspondingly increased approximately 260 s post ignition. By the time the front door was opened, the O₂ concentration was 10.5%, the CO₂ concentration was 11%, and the CO concentration was 1.9%. The peak CO₂ concentration (17%) and CO concentration (2.0%) both occurred prior to firefighter intervention. The ventilation and suppression actions did not have an immediate effect on the gas concentrations, although the gases began to trend to ambient after the front door was opened. Gas concentrations at the 5 ft level returned to approximately pre-ignition conditions within 450 s of the front door opening.

The gas concentrations at the 1 ft location in the doorway first began to change approximately 300 s post ignition, as the fire room transitioned through flashover. At the time the front door was opened, the gas concentrations were 11% for O₂, 14.5% for CO₂, and 1.5% for CO. The O₂ concentration continued to decrease and CO and CO₂ concentrations continued to increase following the front door being opened and reached their peak hazard levels—minimum O₂ and peak CO and CO₂. As the vertical vent was completed, O₂ began to increase while CO₂ and CO decreased. This trend continued through suppression from the stairs, but when water flow from the stairs stopped, the trend in gas concentrations changed. The O₂ began to drop and CO and CO₂ increased as combustion gases flowed from the fire room. After suppression began at the fire room doorway, the gas concentrations returned to pre-ignition conditions.



(a) Bedroom 1 Doorway Gas Concentrations

(b) Bedroom 1 Gas Concentrations

	Action/Event	Time (s)
1	Ignition	0
2	Flashover	296
3	Front Door Open	430
4	Vertical Vent Completed	442
5	Flow from Stairs	456
6	Flow from Fire Room Doorway	472
7	Suppression Crew Entered Fire Room	510

Figure 3.85: Gas concentrations for remote locations in Experiment 7. Blue vertical bars indicate time and duration of water flow.

The 1 ft gas concentrations in the center of the remote room followed a similar trend to the 1 ft gas concentrations in the doorway of that room (see Figure 3.85b). Gas concentrations at the 1 ft level in the remote room first begin to change 300 s post ignition, and, similar to the gas concentrations at 1 ft in the doorway, the hazard decreased shortly after fire department intervention when the O₂ concentration was 12%, the CO₂ concentration was 11.6%, and the CO concentration was 1.2%. Though not as significant, there was a slight increase in hazard following water flow from the stairwell and prior to flow from the doorway. After flow from the doorway, conditions returned to pre-ignition conditions.

3.8 Experiment 8 — Interior Suppression Following Vertical Ventilation

Experiment 8 was conducted to evaluate vertical ventilation prior to suppression with the ventilation location over the hallway adjacent to the fire room. At 201/203 Water Street in Sidney, Ohio, a two-story, 3,074 sq ft wood frame structure was instrumented to conduct this second-floor bedroom fire experiment. The four exterior sides of the structure appear in Figure 3.86. The structure was built with rough cut lumber framing with wood-slat siding. The foundation was a mix of poured concrete and concrete block. The hip-style roof was constructed using 1 in.-by-6 in. sheathing covered with asphalt shingles. Interior walls were finished with plaster and lath while interior floors were finished with carpet in both bedrooms and wood elsewhere. Detailed dimensioned drawings for the first and second story appear in Appendix Figures B.1 and B.2, respectively.



Figure 3.86: Exterior photographs of the structure for Experiment 8.

Originally a single-family home, the building was last used as multiple tenant spaces with two apartments on the first-floor and two on the second-floor. The second-floor apartments were re-configured for the experiment as two bedrooms with a common access stairway. These areas,

accounting for 584 sq ft, define the experimental volume of the structure. All other spaces within the structure were isolated from the experimental volume and used to protect instrumentation. The experimental volume was instrumented for temperature, pressure, heat flux, gas concentrations, IR, and standard video to document the fire dynamics and occupant exposure during the experiment. Figure 3.87 shows the layout of the second-floor with the instrumentation locations.

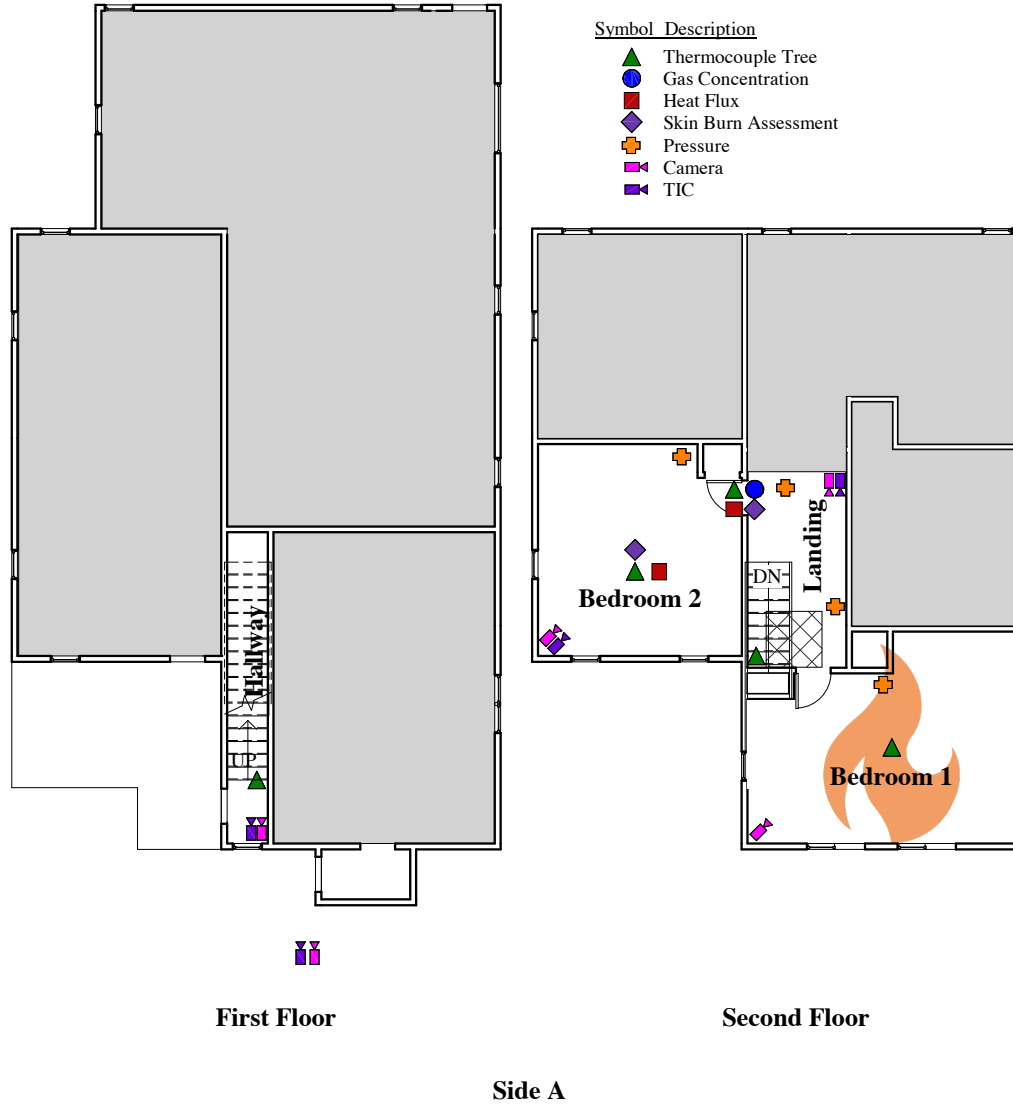

Figure 3.87: Instrumentation and floor plan for Experiment 8. The gray areas were isolated from the remainder of the structure and utilized as space for instrumentation. The cross-hatched area indicates the size and location of the vertical vent. Not shown on this plan was an additional thermocouple array located in the attic.

Bedroom 1, the fire room, was furnished with the bedroom fuel package described in Section 2.4.1.

Photographs of the fire room prior to ignition are presented in Figure 3.88. A dimensioned layout of the fire room is included in Figure 3.89.



(a) A/B Corner

(b) Doorway



(c) Side D Wall

Figure 3.88: Interior photographs of the fire room for Experiment 8.

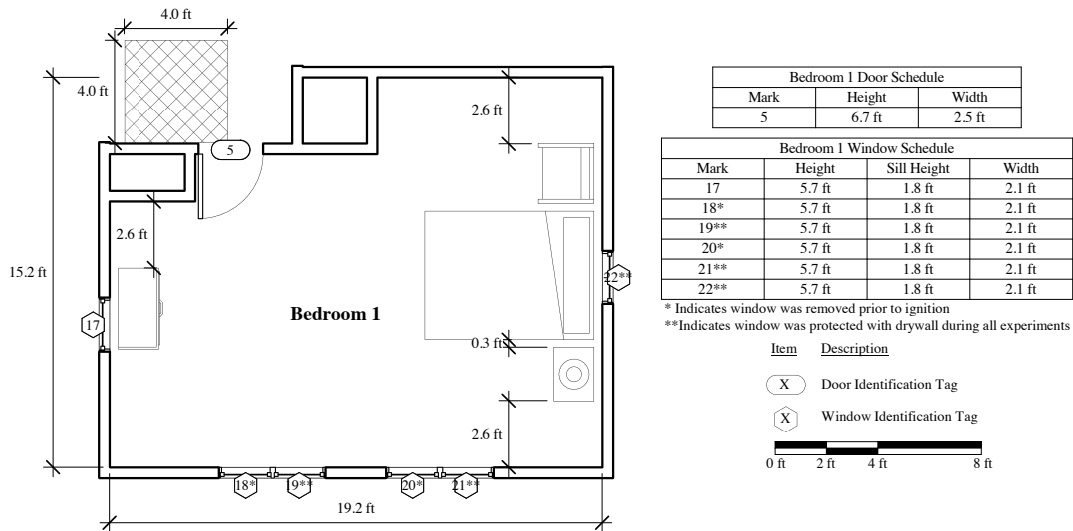

Figure 3.89: Fire room layout for Experiment 8. The cross-hatched area indicates the size and location of the vertical vent.

A 4 ft-by-4 ft roof hole and ceiling hole located over the hallway were cut prior to ignition. The roof hole was covered by plywood and sealed to prevent leakage. The ceiling hole was covered with half-inch gypsum board. Ventilation occurred by first removing the plywood to expose the precut roof hole, simulating a crew cutting a ventilation hole. Immediately following, the interior gypsum was released to expose the precut ceiling hole, simulating a crew removing the compartment ceiling materials. Figure 3.90 shows the covered precut roof opening and the hinged ceiling below.



(a) Roof Vent



(b) Interior Ceiling

Figure 3.90: Vertical ventilation openings for Experiment 8.

The fire was ignited in the upholstered chair. Fire was first visible from the side A window (labeled 21 in Figure 3.89) at 276 s (4:36) post ignition. At approximately 310 s, the fire room approached flashover as temperatures exceeded 1100 °F but remained stratified. Flames were visible from this

window until 437 s (7:17) post ignition, when flames receded into the room.

The front door was opened 450 s (7:30) post ignition. The vertical vent sequence was completed approximately 462 s (7:42) post ignition, or 12 s after the front door was opened. The suppression crew entered through the front door advancing a 1.75 in. hoseline with a combination nozzle set to straight stream approximately halfway up the stairs. The crew began flowing water at 474 s (7:54) post ignition. The initial water application lasted 6 s in duration and suppressed fire venting from the fire room onto the landing. The fire continued to produce flames from both side A windows of the fire room at 485 s (8:05) post ignition. The crew advanced up the stairs to the landing when two events occurred simultaneously. The fire reached flashover as the crew began flowing water from the landing at 491 s (8:11) post ignition. The stream was directed toward the fire room for 7 s. The crew advanced to the fire room doorway before flowing water into the fire compartment at 510 s (8:30) post ignition for 14 s. Once the fire room was cooled sufficiently to enter, the crew entered for final suppression at 526 s (8:56) post ignition. The crew flowed water an additional three times for 4 s, 18 s, and 20 s in duration, respectively.

The total time from the fire department opening the front door open to the fire room entrance was 84 s (1:24). The total water used for initial suppression was 120 gal. This does not include the water flowed during mop-up operations. Figure 3.91 shows the sequence of events with an isometric image of the structure.

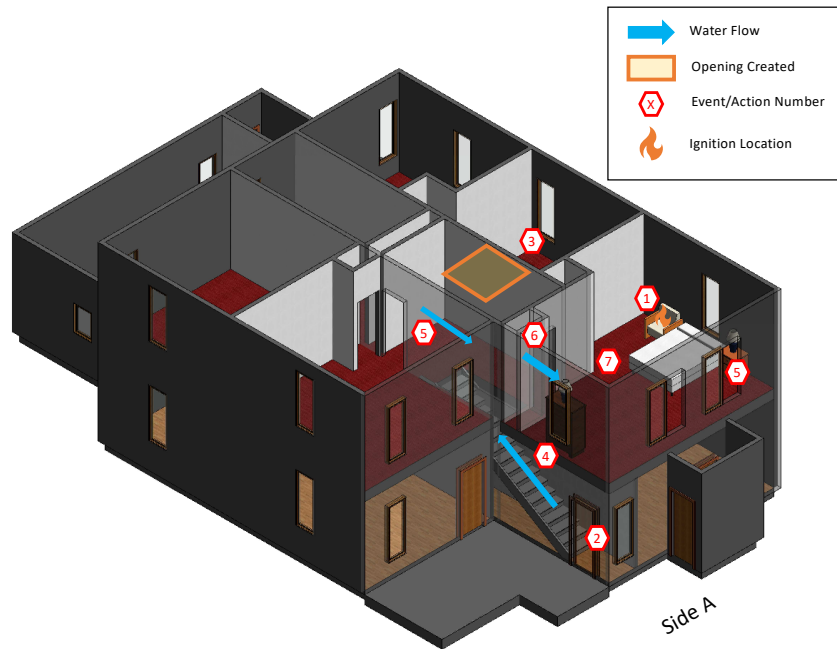

Action/Event	Time (mm:ss)	Time (s)
1 Ignition	00:00	0
2 Front Door Open	07:30	450
3 Vertical Vent Completed	07:42	462
4 Flow from Stairs	07:54	474
5 Flashover & Flow from Landing	08:11	491
6 Flow from Doorway	08:30	510
7 Suppression Crew Entered Fire Room	08:56	526

Figure 3.91: Time and sequence of actions and events for Experiment 8. Note: That there are two icons for Event 5. Event 5 at the top of stairs indicates the flow from the landing while Event 5 at the window indicates flashover.

Figure 3.92 shows the time history of the temperature variations in the fire room. Prior to firefighter intervention, temperatures exceeded 1100 °F at approximately 310 s post ignition. Temperature remained stratified through the start of firefighter actions. The front door was opened 450 s post ignition and the landing vertical vent was completed 12 s later. The change in ventilation led to an increase in fire room temperatures that peaked as the fire room transitioned to flashover at 492 s, 40 s after the front door was opened and 30 s after the vertical vent was completed. Water application from the stairway (Event 4) did not have a major impact on the temperatures in the fire room because the water application was directed to flames above the crew. Water application from the top of the landing, which was applied as the room transitioned to flashover (Events 5), led to an initial decrease in fire room temperatures, but without direct suppression the fire began to regrow after the flow stopped. Suppression from the fire room doorway (Event 6) and within the fire room

itself resulted in a permanent decrease in temperatures.

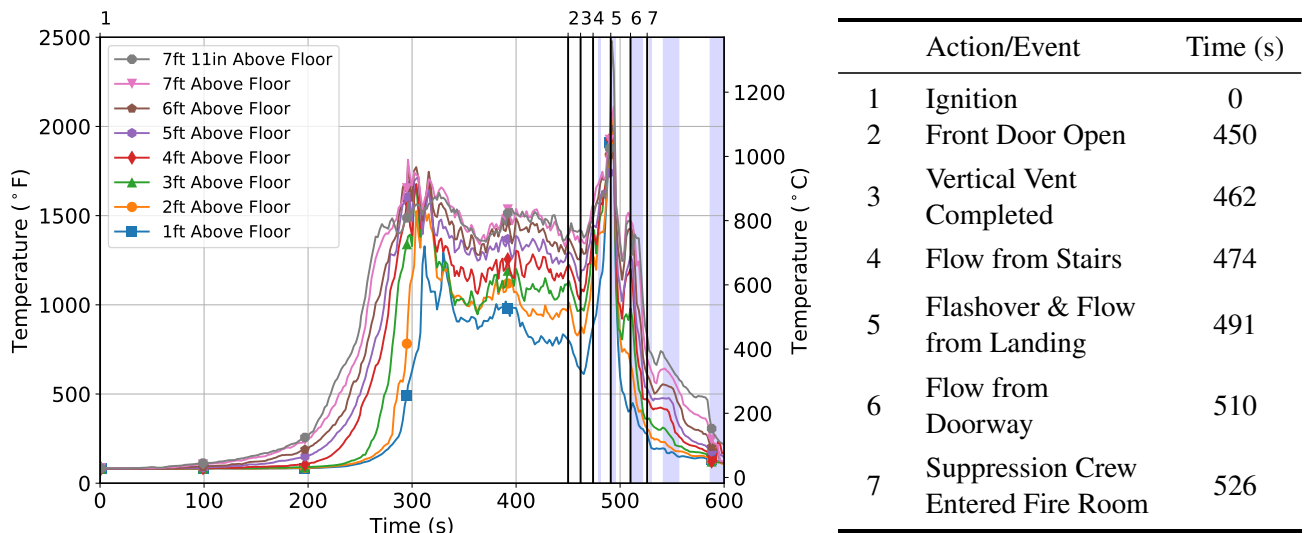
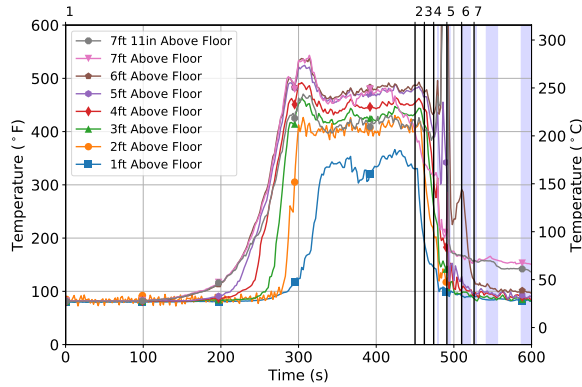

Figure 3.92: Fire room (bedroom 1) temperatures for Experiment 8. Blue vertical bars indicate time and duration of water flow.

After the hallway vent was completed, fire was visible on the landing as hot gases exiting the fire room were able to mix with fresh air that entered from the open front door and ignite. This resulted in an increase in landing thermocouple temperatures close to the ceiling, as shown in Figure 3.93a. The 6 ft and 8 ft temperatures in the landing increased from approximately 450 °F to 640 °F and 830 °F, respectively. Note: That the 7 ft thermocouple began to drop around 425 s while the remainder of the thermocouples measurements did not decrease. It is believed that the 7 ft thermocouple bead made contact with the stairwell wall and no longer measured gas temperature. The landing suppression action, which occurred 36 s after the front door was opened, was effective at reducing the temperatures close to the ceiling.



(a) Landing Temperatures

Action/Event	Time (s)
1 Ignition	0
2 Front Door Open	450
3 Vertical Vent Completed	462
4 Flow from Stairs	474
5 Flashover & Flow from Landing	491
6 Flow from Doorway	510
7 Suppression Crew Entered Fire Room	526

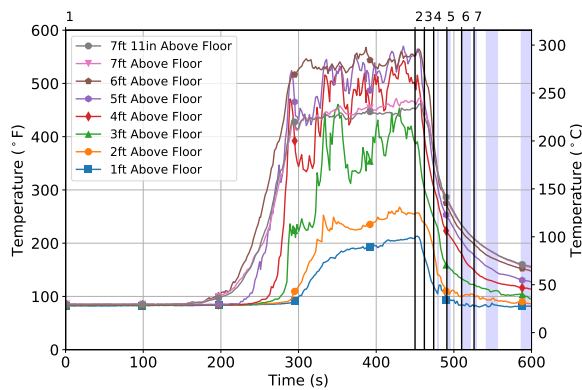

(b) Bedroom 2 Doorway Temperatures

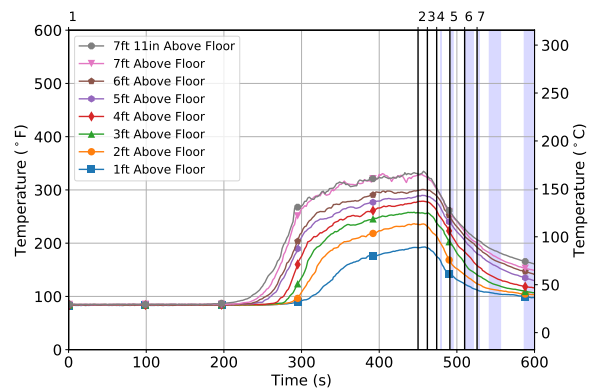

(c) Bedroom 2 Temperatures

Figure 3.93: Temperatures remote from the fire room for Experiment 8. Blue vertical bars indicate time and duration of water flow.

At the bedroom 2 doorway (see Figure 3.93b) and at the center of bedroom 2 (see Figure 3.93c), temperatures began to decline at all elevations after the front door and the vertical vent were opened. The vertical vent was positioned between the fire room and bedroom 1. The distance of bedroom 1 from the fire room and the coordinated suppression that occurred as fire began to extend to the hallway prevented a rise in temperature at the remote locations despite the rise in fire room temperatures.

A thermocouple array was also installed in the attic space to quantify the impact of the vertical ventilation. Temperatures increased following the completion of the vent opening (see Figure 3.94) and peaked to approximately 430 °F. Attic temperatures began to decrease after the suppression crew flowed water from the landing, and continued to decrease as they advanced to the fire room doorway and continued suppression.

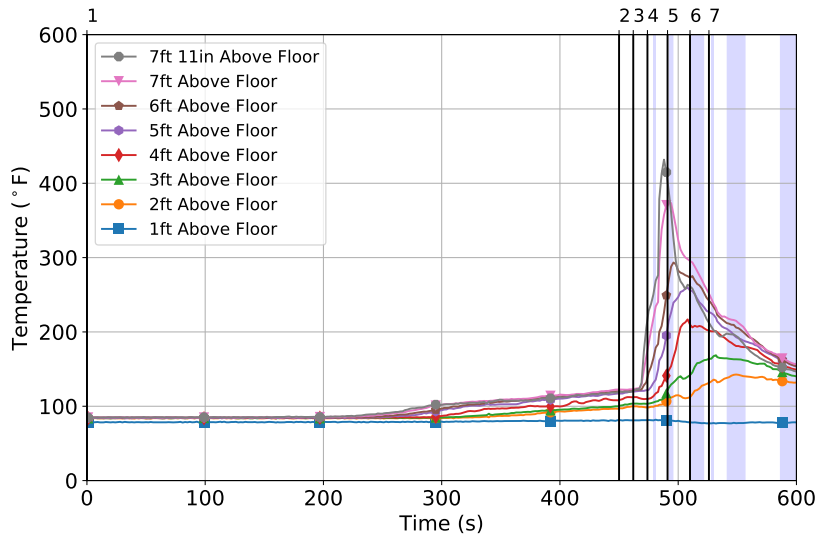

Action/Event	Time (s)
1 Ignition	0
2 Front Door Open	450
3 Vertical Vent Completed	462
4 Flow from Stairs	474
5 Flashover & Flow from Landing	491
6 Flow from Doorway	510
7 Suppression Crew Entered Fire Room	526

Figure 3.94: Attic temperatures for Experiment 8. Blue vertical bars indicate time and duration of water flow.

Figure 3.95 shows the pressure in the fire room during Experiment 8. In the period prior to the front door being opened, when the fire room temperatures had reached steady state, the 7 ft pressure measured 8 Pa above ambient. This is an indication gases at that elevation were exhausting from the fire room. At 4 ft above the floor, the pressure fluctuated around 0 Pa, an indication of neutral or no flow. The pressure at the 1 ft elevation was negative, an indication of an intake for fresh air low into the fire room. The vertical ventilation remote from the fire compartment did not impact the local pressure. Pressures did not return to ambient until the fire was suppressed.

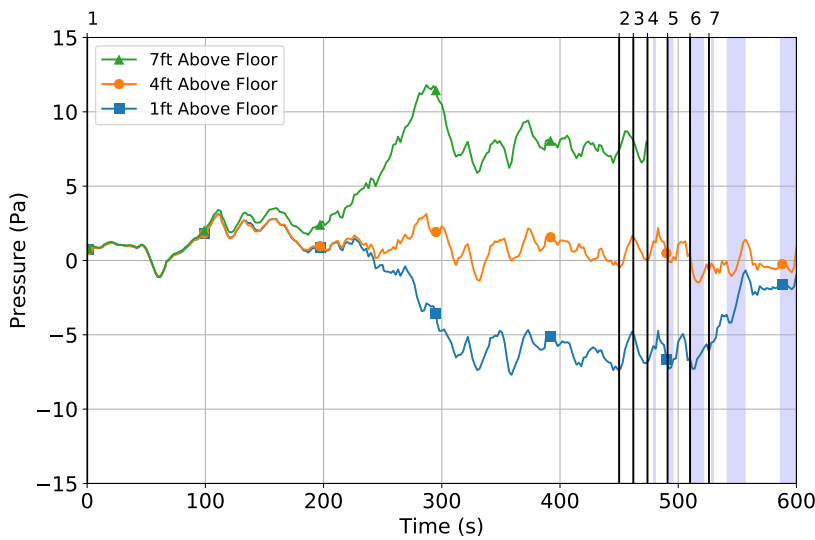

Action/Event	Time (s)
1 Ignition	0
2 Front Door Open	450
3 Vertical Vent Completed	462
4 Flow from Stairs	474
5 Flashover & Flow from Landing	491
6 Flow from Doorway	510
7 Suppression Crew Entered Fire Room	526

Figure 3.95: Changes in pressure in fire room (bedroom 1) for Experiment 8. Blue vertical bars indicate time and duration of water flow.

Prior to ventilation, the hallway and bedroom 2 pressures were similar to the fire room. During the growth phase of the fire (approximately the first 200 s), the pressure did not vary as a function of elevation as all three elevations increased above ambient. At 200 s post ignition, when temperature rises were noticeable in the remote space, the 7 ft elevations continued to increase as the hot gases filled the second-floor. Pressure at the 4 ft and 1 ft elevations began to decrease—in all three locations the pressure dropped below ambient—as air was drawn toward the fire. After the front door was opened, all pressures remote from the fire room rose as a low-pressure inlet was created. At 462 s post ignition, when the vertical vent was created, all pressures in Figure 3.95 decreased. The vertical vent provided an exhaust path for the high-temperature, high-pressure fire gases to exhaust the structure. Following suppression from the fire room doorway, all pressures returned to ambient.

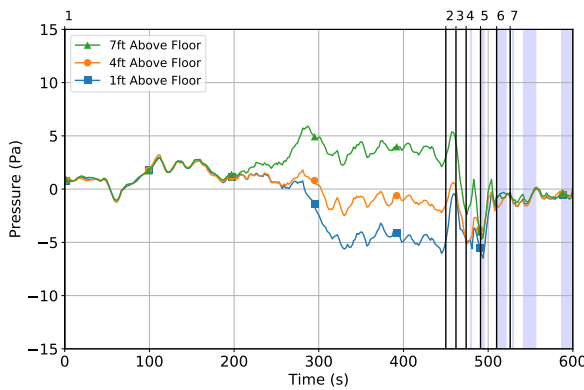

(a) Hallway Pressure

Action/Event	Time (s)
1 Ignition	0
2 Front Door Open	450
3 Vertical Vent Completed	462
4 Flow from Stairs	474
5 Flashover & Flow from Landing	491
6 Flow from Doorway	510
7 Suppression Crew Entered Fire Room	526

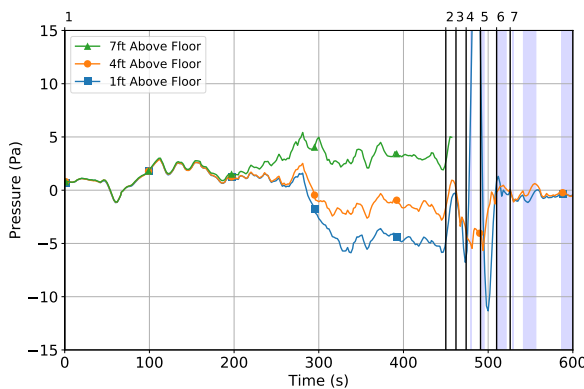

(b) Hallway Pressure Outside Bedroom 2

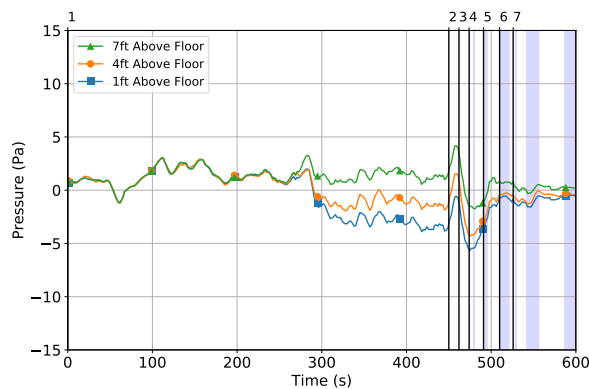

(c) Bedroom 2 Pressure

Figure 3.96: Pressures in hallway outside fire room (see Figure 3.96a), in hallway outside bedroom 1 (see Figure 3.96b), and in bedroom 1 (see Figure 3.96c) for Experiment 8, with vertical ventilation above the hallway. Blue vertical bars indicate time and duration of water flow.

Bi-directional flows were initially established through open fire room windows and at the fire room doorway. Prior to the front door being opened (see Figure 3.97a), the fire room doorway flow became less efficient as the structure filled with smoke and the fresh air became depleted. The open front door at 450 s post ignition allowed for the entrainment for more fresh air into the fire

room than was possible with the door closed. This changed the flow; a flow path was established between the open front door and fire room. This change is shown in Figure 3.97b. The open front door allowed for more air to flow through the fire room door, therefore the fire room windows became a more efficient exhaust.

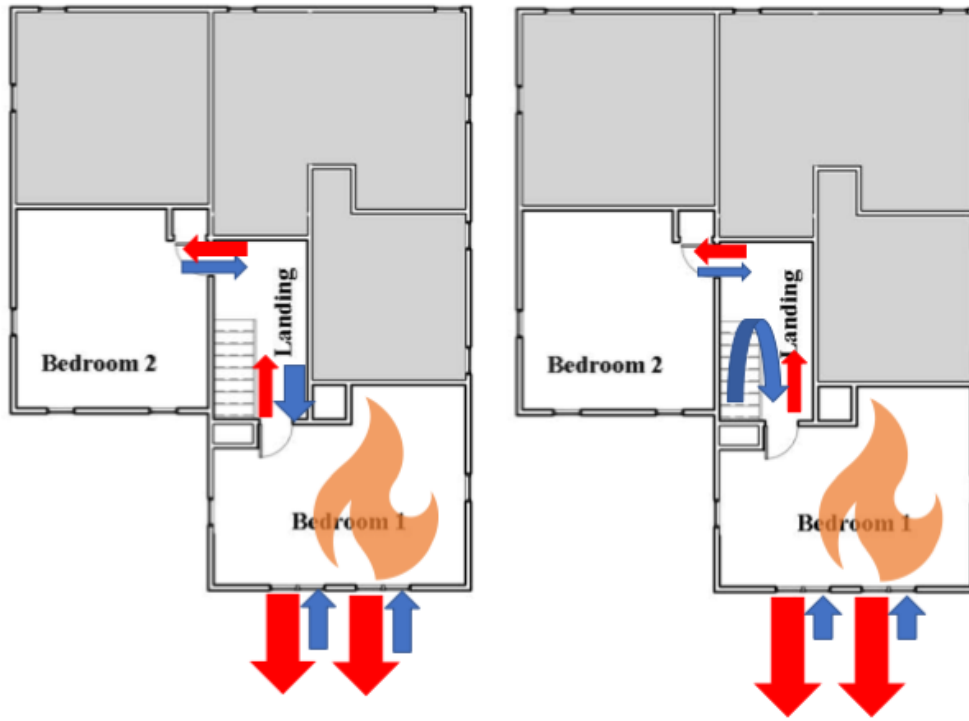

(a) Prior to Front Door Opened

(b) After Front Door Opened

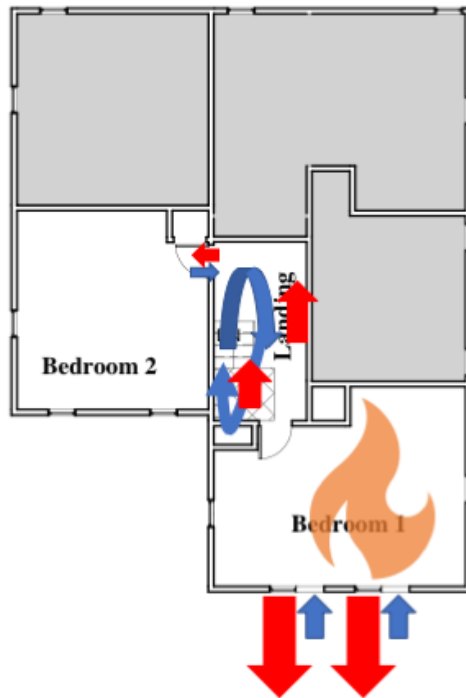

(c) After Vertical Ventilation

Figure 3.97: Changes in flows for Experiment 8 as function of firefighter ventilation. Red arrows indicate the flow of combustion products, blue arrows indicate the flow of fresh air, and the sizes of the arrows indicate the relative magnitude of the flow.

When the vertical vent was opened (see Figure 3.97c), products of combustion were exhausted from the fire room through both the windows and the top half of the fire room doorway. The intake and exhaust openings that had the potential to be the most efficient vents were offset from the fire room, and therefore less efficient. The fire room doorway became the restriction point for the amount of flow able to enter and leave the fire room.

Heat flux locations for Experiment 8 were located 1 ft above the floor and 5 ft above the floor in the doorway of bedroom 2 and 1 ft above the floor in the center of bedroom 2. The heat flux measurements for the doorway location followed a similar trend to the temperatures at that location. Prior to the front door opening, the peak heat flux at each elevation was 12.0 kW/m² and 4.0 kW/m², respectively. The removal of combustion products from the fire floor following ventilation led the heat flux at both elevations to decline to 4.0 kW/m² and 1.1 kW/m² at the 5 ft and 1 ft. Suppression further reduced the heat flux to less than 1 kW/m² at both elevations within approximately 100 s of firefighter intervention. Note: The heat flux gauge in bedroom 2 remained negligible for the duration of experiment.

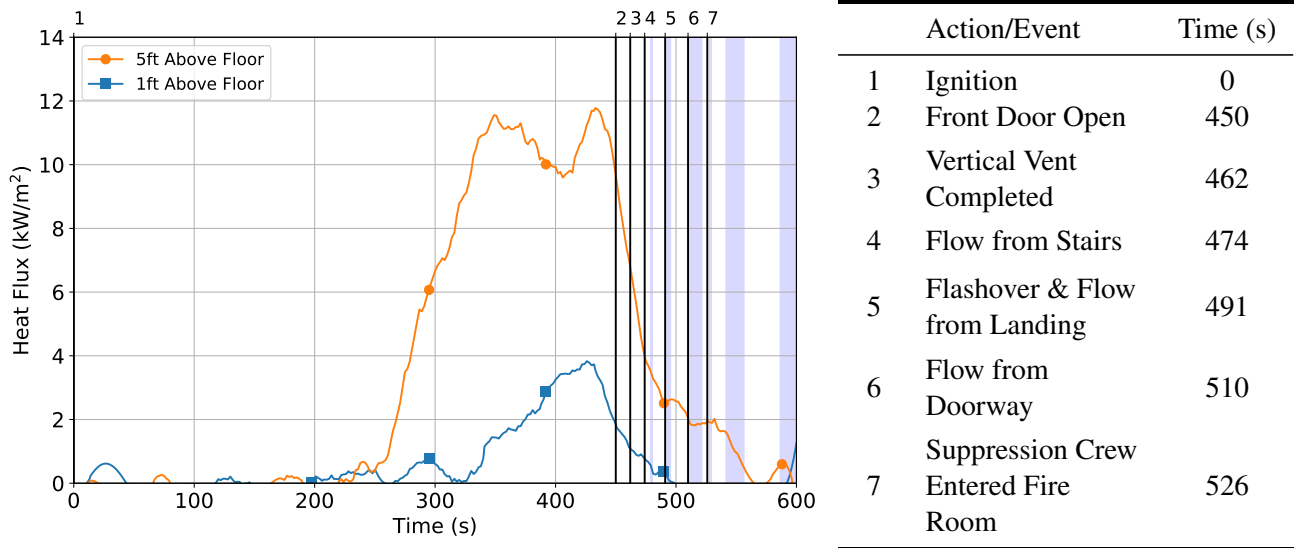
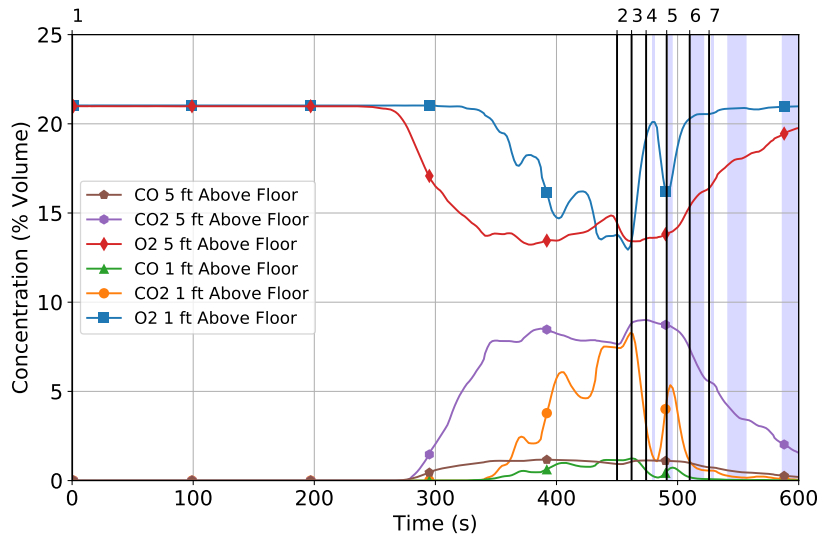

Figure 3.98: Changes in heat flux in bedroom 2 for Experiment 8. Blue vertical bars indicate time and duration of water flow.

The 5 ft gas location at the bedroom 2 doorway first showed signs of CO and CO₂ concentration increase and O₂ concentration depletion 240 s post ignition. The O₂ concentration dropped to 13%, below the 15% level where combustion could be supported. The 1 ft elevation lagged in response, dropping at approximately 300 s post ignition, because it took longer for the smoke layer to descend. Post vertical ventilation and water flow from the stairs, the the 1 ft elevation recovered back to 20% O₂ concentration. Following the initial water flow, the O₂ concentration dropped along with a corresponding rise in CO and CO₂ concentration as the fire room transitioned to flashover and combustion gases flowed from the fire room. Following suppression from the fire doorway, gases at both elevations began to recover to pre-ignition conditions.



	Action/Event	Time (s)
1	Ignition	0
2	Front Door Open	450
3	Vertical Vent Completed	462
4	Flow from Stairs	474
5	Flashover & Flow from Landing	491
6	Flow from Doorway	510
7	Suppression Crew Entered Fire Room	526

Figure 3.99: Gas concentrations for bedroom 2 doorway location for Experiment 8. Blue vertical bars indicate time and duration of water flow.

3.9 Experiment 9 — Interior Suppression with Simultaneous Positive Pressure Ventilation

Experiment 9 was designed to evaluate the effect of positive pressure ventilation and interior suppression when coordinated simultaneously. Positive pressure ventilation occurred on side A at the front door. At 1030 Hilltop Road in Xenia, Ohio, a two-story, 2,200 sq ft wood frame structure was instrumented to conduct this second-floor bedroom fire experiment. The four exterior sides of the structure appear in Figure 3.100. The structure was stick-built with rough cut lumber framing with wood-slat siding. The foundation was a combination of block and stone. The original house had a hip-style tin roof supported by wood members and the rear addition had a peaked roof constructed using 1 in.-by-6 in. sheathing covered with asphalt shingles. Interior walls in the original house were finished with plaster and lath while the addition was finished with gypsum board. Interior floor coverings included vinyl tile in the kitchen, wood in the dining room, and carpet in all other areas. Detailed dimensioned drawings for the first and second story appear in Appendix Figures B.12 and B.13, respectively.



(a) Side A



(b) Side B



(c) Side C



(d) Side D

Figure 3.100: Exterior photographs of the structure for Experiment 9.

The first-floor had a kitchen, dining room, family room, and flex space. The second-floor had three bedrooms and a flex space. A stairwell located on side A connected the two floors. These areas defined the experimental volume of the structure. The spaces located on the first-floor in the A/D corner and on the second-floor along side D were isolated from the experimental volume and utilized as instrumentation space. The structure was instrumented for temperature, pressure, heat flux, IR, and standard video to capture the fire dynamics during experimentation. Instrumentation was also installed to characterize the potential for skin burns and occupant toxic exposure during the experiment. Figure 3.101 shows the layout of the second-floor with the instrumentation locations.



Figure 3.101: Instrumentation and floor plan for Experiment 9. The gray areas were isolated from the remainder of the structure and utilized as space for instrumentation.

Bedroom 3, the fire room, was furnished with the bedroom fuel package described in section 2.4.1. Photographs of bedroom 3 prior to ignition are presented in Figure 3.103 A dimensioned layout

of the fire room is included in Figure 3.102. To replicate a similar volume of space found in other experiments, bedroom 1 and bedroom 2 remained closed throughout the experiment. To allow for repeatable fire growth, the windows labeled 20 and 21 in Figure 3.103 were removed prior to ignition.



(a) Side A

(b) A/D Corner



(c) Doorway

Figure 3.102: Interior photographs of the fire room for Experiment 9.

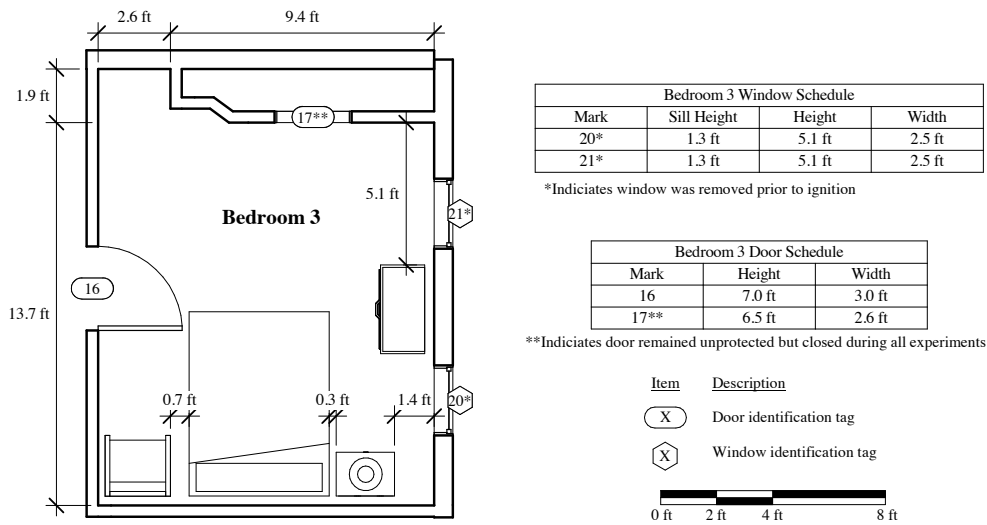
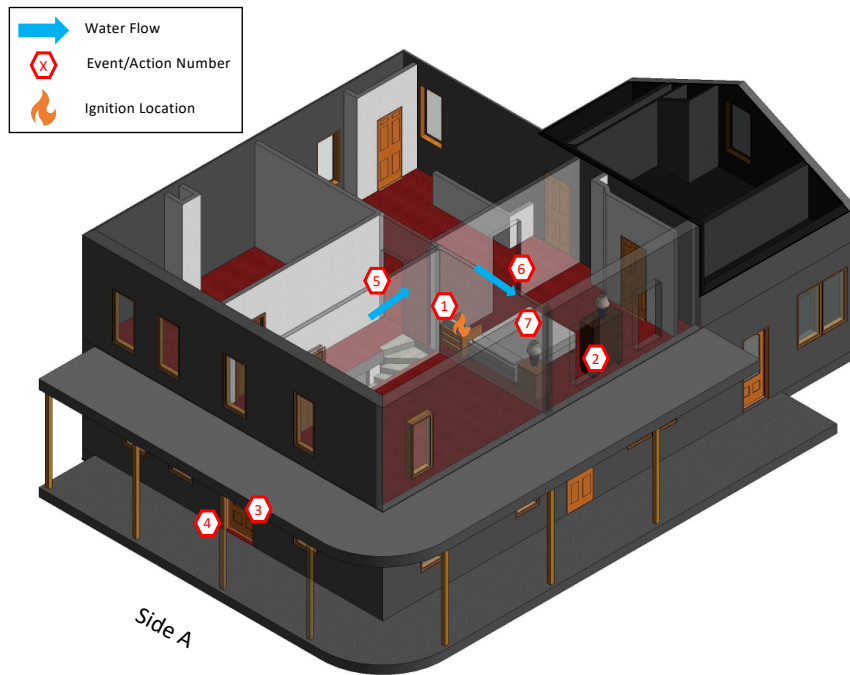

Figure 3.103: Fire room layout for Experiment 9.

The fire was ignited in the upholstered chair. Flames were first visible from window 20 (in Figure 3.103) 212 s (3:32) post ignition. Flames were visible in both windows (labeled 20 and 21 in Figure 3.103) 225 s (3:45) post ignition. Bedroom 3 reached flashover at 240 s (4:00) post ignition. The fire transitioned to a post-flashover state with fire venting from both open windows before fire department interventions occurred.

The front door was opened at 390 s (6:30) post ignition. The fan was started prior to the door opening and turned into position approximately 10 s after the door was opened². After a flow path through the structure was established approximately 405 s (6:45) post ignition, the suppression crew entered through the front door. The suppression crew advanced a 1.75 in. hoseline with a combination nozzle set to straight stream up the stairs. The suppression crew reached the top of the stairs and flowed water toward the fire room at 435 s (7:15) post ignition for a duration of 6 s. This initial water application was directed across the flex space, toward the instrumentation room. The crew advanced to the fire room doorway with the bale cracked, flowing water for 9 s. The crew reached the fire room doorway 450 s (7:30) post ignition and fully opened the nozzle to flow water a second time at 455 s (7:35) post ignition for 15 s. Once the nozzle firefighter determined the fire room was cooled sufficiently to enter, the suppression crew entered for final suppression 527 s (8:47) post ignition. The crew applied water to the fire two additional times for 13 s and 15 s in duration, respectively. The entire tactic from front door open to occupying the fire room was 133 s (2:13). The total amount of water flowed for initial suppression was 109 gal, which does not include water flowed during mop-up operations. Figure 3.104 shows the sequence of events with an isometric image of the structure.

²An electric positive pressure fan with 14,155 CFM capacity was placed approximately 10 ft from the front door at an angle of 95°. Firefighters ensured flow through the top of the doorway and that the fan was at full throttle.



Action/Event	Time (mm:ss)	Time (s)
1 Ignition	00:00	0
2 Flashover	04:00	240
3 Front Door Open	06:30	390
4 PPV Fan Turned In	06:41	401
5 Flow from Top of Stairs	07:15	435
6 Flow from Doorway	07:35	455
7 Suppression Crew Entered Fire Room	08:47	527

Figure 3.104: Time and sequence of actions and events for Experiment 9.

The fire room temperatures are shown in Figure 3.105. The room transitioned to flashover approximately 240 s post ignition, when the temperature close to the floor exceeded 1100 °F. After the front door was opened and the positive pressure fan was turned in, temperatures within the fire room increased for 30 s, prior to final suppression in the fire room.

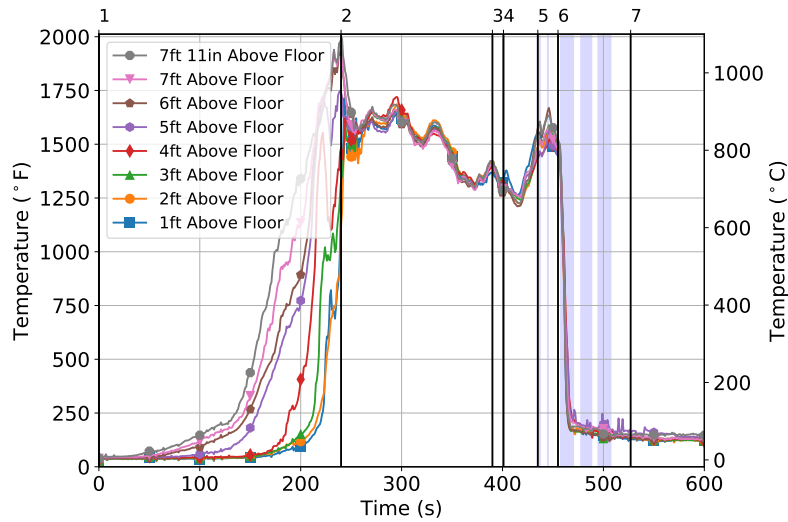

	Action/Event	Time (s)
1	Ignition	0
2	Flashover	240
3	Front Door Open	390
4	PPV Fan Turned In	401
5	Flow from Top of Stairs	435
6	Flow from Doorway	455
	Suppression	
7	Crew Entered Fire Room	527

Figure 3.105: Fire room (bedroom 3) temperatures for Experiment 9. Blue vertical bars indicate time and duration of water flow.

At the time the front door was opened, the temperatures in the flex space were steady or gradually increasing, and were stratified as shown in Figure 3.106. When the front door was opened, the temperatures close to the ceiling ranged between 600 °F and 650 °F, the 2 ft temperature was 275 °F, and the 1 ft temperature was 140 °F. Once the front door was opened and the positive pressure fan was introduced, temperatures in the flex space began to decrease at all elevations, although the most notable changes occurred at the 1 ft through 3 ft elevations. The largest temperature decrease across all elevations occurred at approximately 455 s (7:35) post ignition, which was the time at which the nozzle firefighter began suppression with the bale fully opened in the doorway of the fire room. Flex space temperatures continued to decrease as suppression occurred in the fire room.

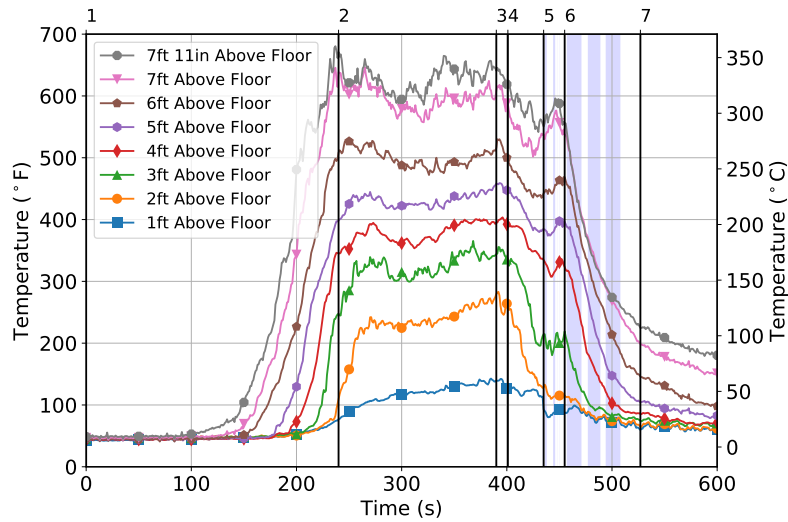

	Action/Event	Time (s)
1	Ignition	0
2	Flashover	240
3	Front Door Open	390
4	PPV Fan Turned In	401
5	Flow from Top of Stairs	435
6	Flow from Doorway	455
7	Suppression Crew Entered Fire Room	527

Figure 3.106: Flex space temperatures for Experiment 9. Blue vertical bars indicate time and duration of water flow.

Figure 3.107 shows the temperatures in the hallway, which followed a similar trend to those in the flex space. The temperatures in the hallway began to reach steady values following flashover in the fire room. At the time the front door was opened, the temperatures close to the ceiling were steady, while those closer to the floor were gradually increasing. When the front door was opened, the smoke layer was between 1 ft and 2 ft in the hallway, as indicated by both the camera view in the hallway and the 102 °F difference between the 1 ft and 2 ft temperatures at this time. There was a significant decrease in the hallway temperatures following the opening of the front door and the introduction of the fan. In the time between front door open and initial water application, the 2 ft temperatures decreased from 165 °F to 60 °F and the 3 ft temperatures decreased from 215 °F to 90 °F. The temperature drop at elevations close to the ceiling was also greater than was observed in the flex space. Similar to the flex space temperatures, the hallway temperatures at all levels dropped substantially when the nozzle firefighter reached the fire room and began to flow water 455 s post ignition.

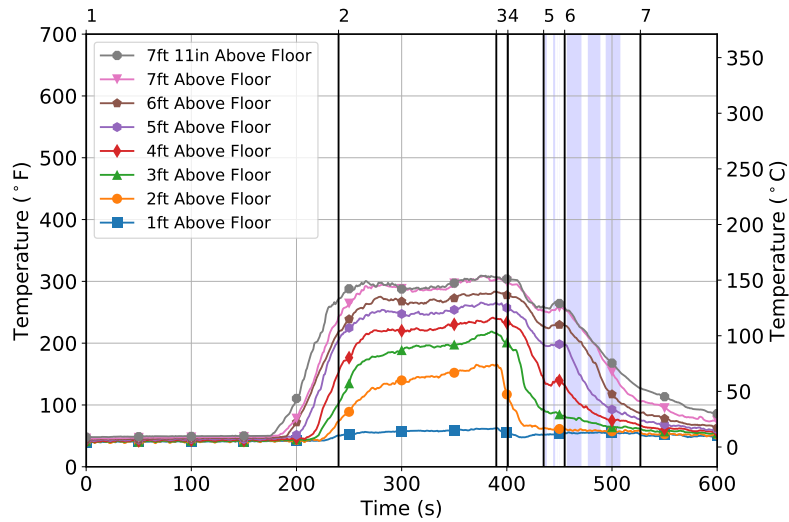

	Action/Event	Time (s)
1	Ignition	0
2	Flashover	240
3	Front Door Open	390
4	PPV Fan Turned In	401
5	Flow from Top of Stairs	435
6	Flow from Doorway	455
7	Suppression Crew Entered Fire Room	527

Figure 3.107: Hallway temperatures for Experiment 9. Blue vertical bars indicate time and duration of water flow.

The growth of the bedroom fire was accompanied by an increase in pressure at the 7 ft elevation, as shown in Figure 3.108. The 4 ft pressure began to increase and the 1 ft pressure began to decrease approximately 200 s post ignition. The 1 ft temperature remained negative until the sensor malfunctioned following suppression, whereas the 4 ft sensor fluctuated between positive and negative pressure during this period. The sustained negative pressure at the 1 ft level reflected the entrainment of air through the front door. After the positive pressure fan was turned into the door, the pressures at the 4 ft and 7 ft elevations increased while the 1 ft pressure remained negative.

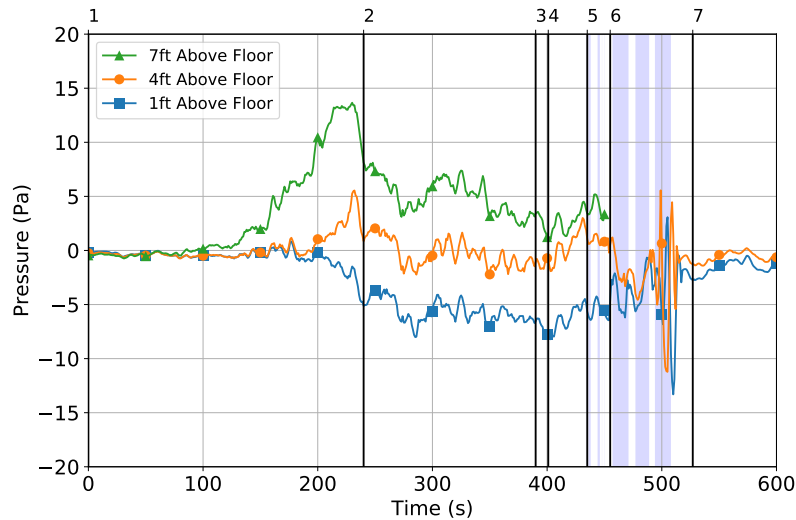

	Action/Event	Time (s)
1	Ignition	0
2	Flashover	240
3	Front Door Open	390
4	PPV Fan Turned In	401
5	Flow from Top of Stairs	435
6	Flow from Doorway	455
	Suppression	
7	Crew Entered Fire Room	527

Figure 3.108: Fire room pressure data for Experiment 9. Data is presented until fire room suppression, when the sensors were damaged. Blue vertical bars indicate time and duration of water flow.

Figure 3.109 shows the pressures for the flex space and the second-floor hallway for Experiment 9. In both locations, as the fire grew, the 7 ft pressure increased to a positive value, reflecting the development of a hot gas layer in these areas. Although the 1 ft pressure sensor at the hallway location malfunctioned, the 1 ft pressure in the flex space decreased below zero around the time of flashover. The 4 ft pressures at both locations fluctuated between positive and negative values in the period prior to the front door being opened. The magnitudes of the pressures at each location remote from the fire room were less than the pressure in the fire room at the corresponding height. Once the positive pressure fan was turned into the doorway, there was an increase in pressure throughout the open spaces remote from the fire room on the second-floor. The pressure increase at the 1 ft and 4 ft elevations in the flex space were sufficient that they were greater than the corresponding pressures in the fire rooms, indicating the flow was into the fire room at these heights. The pressure increase at the 7 ft level was not enough to be greater than the 7 ft pressure in the fire room, although it did decrease the difference between the two values. The changes in pressure following the introduction of the positive pressure fan suggest the positive pressure fan was successful in reducing the flow from the fire room to adjacent spaces of the structure.

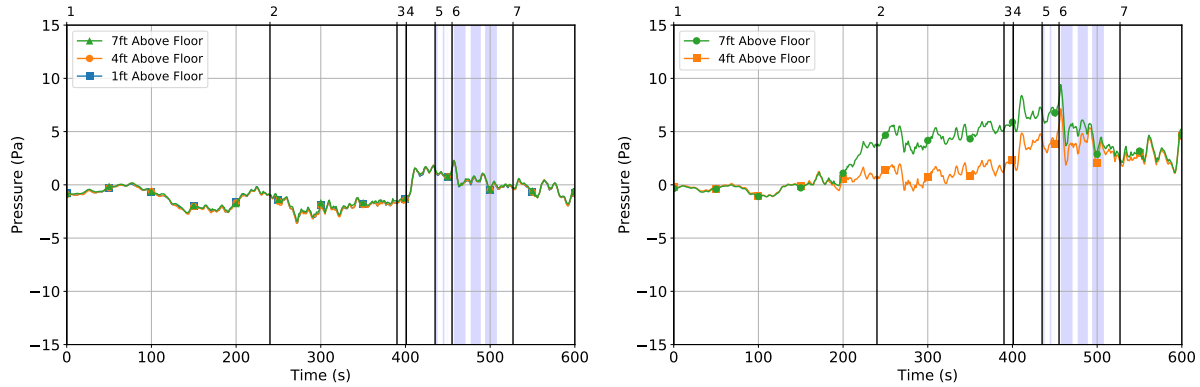

(a) Flex Space Pressure

(b) Stairway Hallway Pressure

	Action/Event	Time (s)
1	Ignition	0
2	Flashover	240
3	Front Door Open	390
4	PPV Fan Turned In	401
5	Flow from Top of Stairs	435
6	Flow from Doorway	455
7	Suppression Crew Entered Fire Room	527

Figure 3.109: Flex space (see Figure 3.109a) and hallway (see Figure 3.109b) pressure for Experiment 9. Blue vertical bars indicate time and duration of water flow.

Figure 3.110 shows the changes in flow within the structure over the course of the experiment. As the fire grew to a point where it became ventilation limited, bi-directional flows were created through the fire room windows—fresh air was entrained into the fire room and hot gases were exhausted from the fire room. Similar flows existed at the fire room doorway, except that the fresh air was drawn from remote parts of the structure and replaced with products of combustion, as shown in Figure 3.110a. The opening of the front door created a more efficient flow path, allowing fresh air to flow into the structure through the front door and travel up the stairs and into the fire room, while hot gases exhausted from the upper portion of the fire room windows and doorway, as shown in Figure 3.110c. The activation of the PPV fan increased the flow through the front door, resulting in an increase in fire room temperatures (see Figure 3.105). Mixing occurred along the inlet portion of the flow path in Figure 3.110b, lowering temperatures as fresh air mixed with hot gases. As the suppression crew reached the fire room and began to flow water, temperatures continued to decrease, as the additional ventilation had a positive impact on conditions.

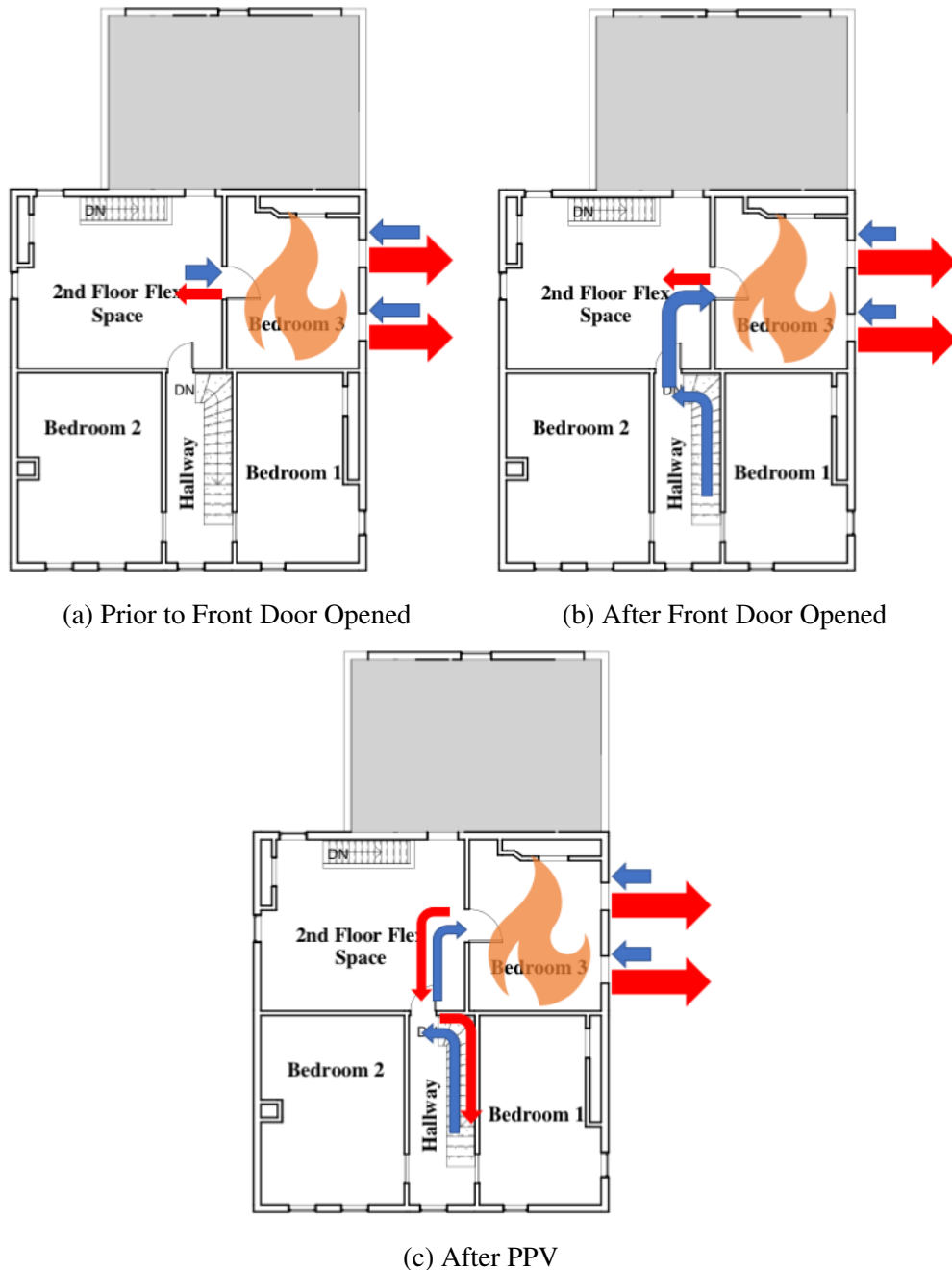
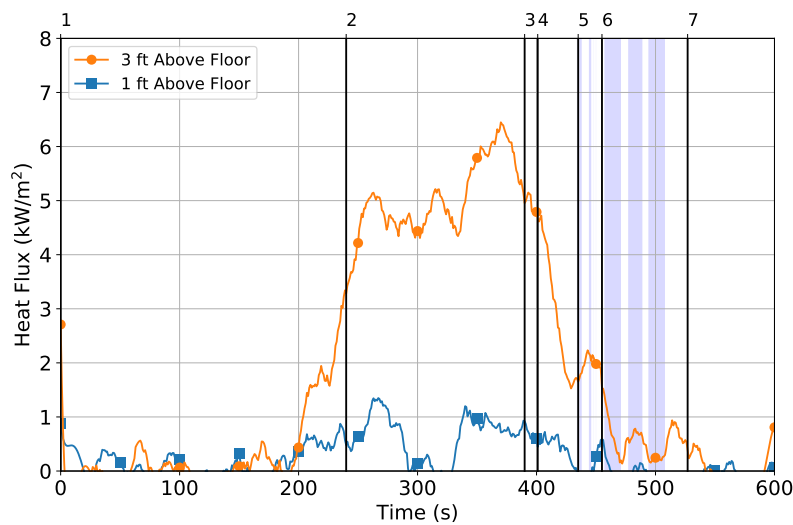

Figure 3.110: Changes in flow during Experiment 9 as a function of firefighter ventilation. Red arrows indicate the flow of combustion products, blue arrows indicate the flow of fresh air, and the sizes of the arrows indicate the relative magnitude of the flow.

The heat flux location for Experiment 9 was located in the center of the flex space adjacent to the fire room at the 1 ft and 3 ft elevations. The heat flux at this location mirrored the behavior observed from the temperature sensors at these elevations. Figure 3.111 shows the heat flux at this location. The peak heat flux at the 3 ft elevation was 6.5 kW/m^2 , and was observed prior to the front door opening. The heat flux in the period prior to fire department intervention was relatively

steady. Once the front door was opened and the fan was turned in, the heat flux dropped to 1.4 kW/m². The heat flux then briefly increased back to 2.2 kW/m² before a final decrease, which corresponded to the nozzle firefighter reaching the fire room and opening the line. The heat flux at the 1 ft elevation was significantly less than the 3 ft elevation. The peak heat flux measured was 1.5 kW/m², occurring prior to the front door opening but remained below 1 kW/m² for the majority of the experiment.



	Action/Event	Time (s)
1	Ignition	0
2	Flashover	240
3	Front Door Open	390
4	PPV Fan Turned In	401
5	Flow from Top of Stairs	435
6	Flow from Doorway	455
7	Suppression Crew Entered Fire Room	527

Figure 3.111: Heat flux for the flex space for Experiment 9. Blue vertical bars indicate time and duration of water flow.

The gas concentrations at the 3 ft elevation were greater than those observed at the 1 ft elevation in the same location. Figure 3.112 shows the gas concentrations in the flex space and hallway for Experiment 9. At the 3 ft elevation in the flex space (see Figure 3.112a), the O₂ concentration started to decrease and CO and CO₂ concentrations started to increase approximately 225 s post ignition. At the time the front door was opened, the gas concentrations were approximately steady at 10.7% for O₂, 6.0% for CO₂, and 1.8% for CO. When the front door was opened and the positive pressure fan introduced, the gas concentrations began to decrease. As the nozzle firefighter applied water from the top of the stairway, CO and CO₂ concentrations began to increase and the O₂ concentration began to decrease. The gas concentrations continued to increase for approximately 10 s, before the flow from the fire room doorway caused the gas concentrations to permanently trend toward ambient.

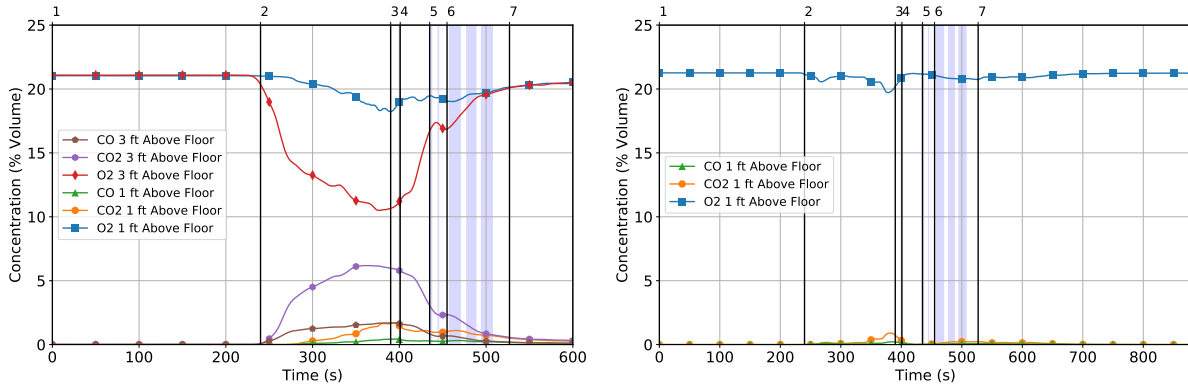

(a) Flex Space Gas

(b) Hallway Gas

Action/Event	Time (s)
1 Ignition	0
2 Flashover	240
3 Front Door Open	390
4 PPV Fan Turned In	401
5 Flow from Top of Stairs	435
6 Flow from Doorway	455
7 Suppression Crew Entered Fire Room	527

Figure 3.112: O₂, CO₂, and CO concentrations for the 1 ft and 3 ft inside flow path locations in the flex space, and for the 1 ft level in the hallway for Experiment 9. Blue vertical bars indicate time and duration of water flow.

The gas concentrations at the 1 ft level in the flex space (see Figure 3.112a) also began to increase around the time of flashover, and were gradually increasing at the time the front door was opened. When the front door was opened, the O₂ concentration was 18.3%, the CO₂ concentration was 3.7%, and the CO concentration was 0.4%. The peak 1 ft gas concentrations were observed when the front door was opened, and the O₂ gradually increased and CO and CO₂ gradually decreased while the fan was activated and suppression began.

The gas concentrations in the hallway (see Figure 3.112b) were less than both the 1 ft and 3 ft elevations in the flex space. The peak gas concentrations were observed after the front door was opened. The lowest O₂ concentration was 19.7% and the peak CO₂ and CO concentrations were 0.9% and 0.3%, respectively. A reason the gas concentrations in this location were less than other location in the structure is likely due to the layer height in the hallway being above the 1 ft sample point. Additionally, the location was directly above the stairway and may have been impacted by the fresh air entrained onto the second-floor through the staircase.

Bedroom Fires Method 3

3.10 Experiment 10 — Exterior Fire Control with No Additional Ventilation

Experiment 10 was conducted to examine initial exterior water with no additional ventilation; this was the control experiment for Coordination Method 3. At 230 North Walnut Street in Sidney, Ohio, a two-story, 2,074 sq ft, wood frame structure was instrumented to conduct this second-floor bedroom fire experiment. The four exterior sides of the structure appear in Figure 3.113. The structure was stick-built with rough cut lumber framing with wood-vinyl siding. The foundation was a combination of brick and concrete block. The peaked-gable roof was constructed using 1 in.-by-6 in. sheathing covered with asphalt shingles. Detailed dimensioned drawings for the first and second stories appear in Appendix Figures B.3 and B.4, respectively.



(a) Side A



(b) B/C Corner



(c) Side C



(d) Side D

Figure 3.113: Exterior photographs of the structure for Experiment 10.

The first-floor had a entry way, living room, family room, and kitchen. The second-floor had three bedrooms. A stairwell connected the two floors. These areas defined the experimental volume of the structure. A second-floor bedroom, bathroom, and rear stairway were isolated and utilized as instrumentation space. The structure was instrumented for temperature, pressure, heat flux, IR, and standard video to capture the fire dynamics during experimentation. Instrumentation was also installed to characterize the potential for skin burns and occupant toxic exposure during the experiment. Figure 3.114 shows the layout of the first and second-floors with the instrumentation locations.

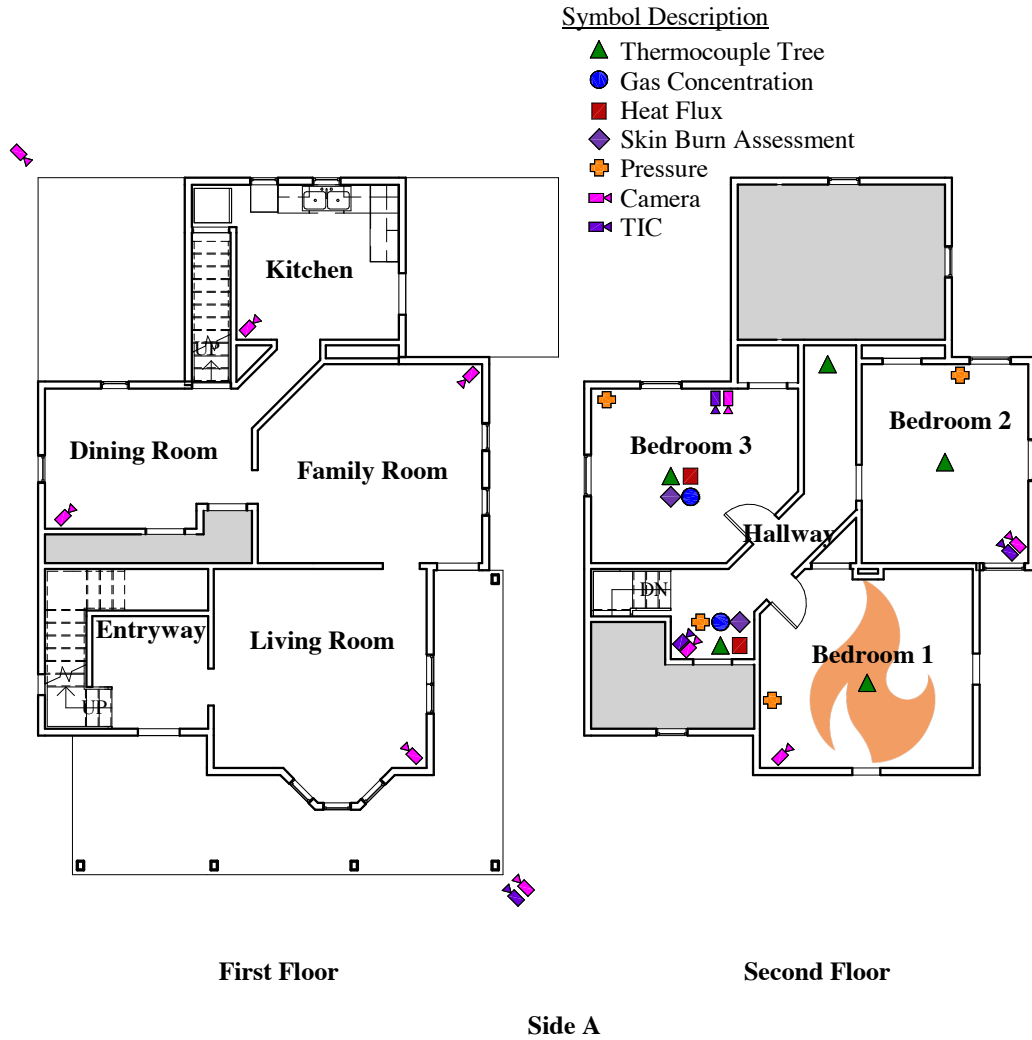

Figure 3.114: Instrumentation and floor plan for Experiment 10. The gray areas were isolated from the remainder of the structure and utilized as space for instrumentation.

The fire room (bedroom 1) was furnished with the bedroom fuel package described in section 2.4.1. Photographs of the fire room (bedroom 1) prior to ignition are presented in Figure 3.115. A dimensioned layout of the fire room is included in Figure 3.116. To replicate a similar volume of

space found in other experiments, bedroom 2 remained closed throughout the experiment. To allow for repeatable fire growth, the windows located on side A and side D (labeled 13 and 14 in Figure 3.116) were removed prior to ignition.



(a) A/D Corner

(b) Side A Wall



(c) Doorway

Figure 3.115: Interior photographs of fire room for Experiment 10.

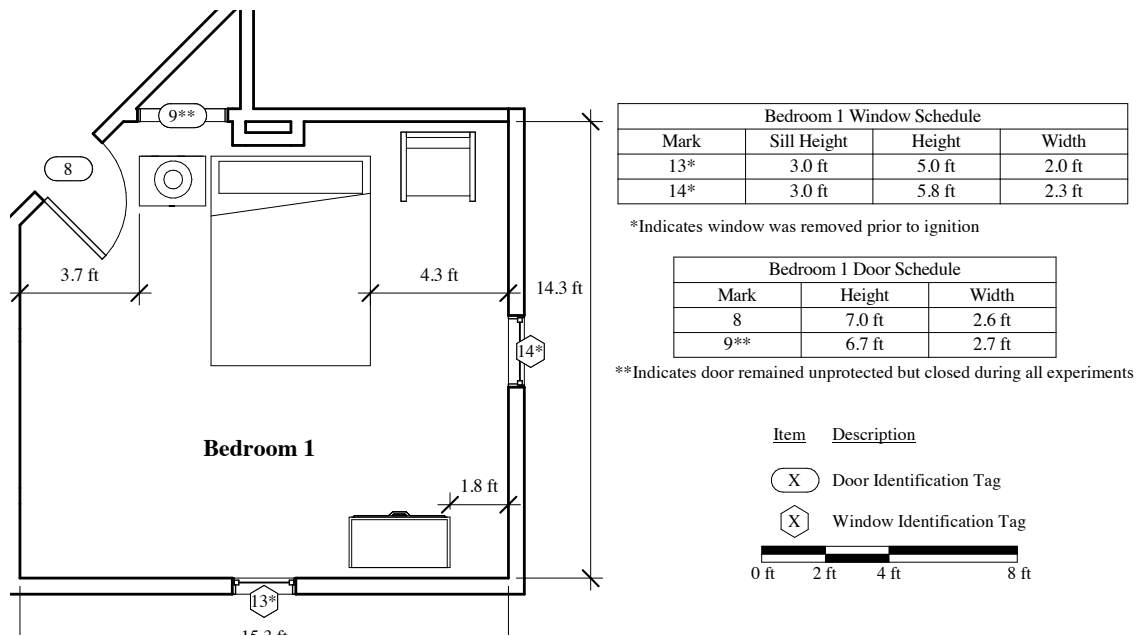

Figure 3.116: Fire room layout for Experiment 10.

The fire was ignited in the upholstered chair next to the mattress in the fire room (bedroom 1). After ignition, the fire grew, and flames were visible from the side D window, 267 s (4:27) post ignition. Fire was observed from the side A window 322 s (5:22) post ignition. The fire continued to grow until flashover occurred 329 s (5:29) post ignition. The fire then transitioned into a post-flashover state before the initial fire department intervention.

Initial fire department intervention was exterior water flow through the side D window 452 s (7:32) post ignition. This exterior water flow lasted 11 s in duration. The front door was opened concurrently with the end of the exterior water flow action 464 s (7:44) post ignition. The suppression crew repositioned the hoseline and proceeded through the opened front door. The suppression crew advanced up the stairs, applying water from the top of the stairway 541 s (9:01) post ignition for 8 s.

The crew advanced to the fire room doorway and flowed water at 567 s (9:27) for 20 s. Once the fire room was cooled sufficiently to enter, the crew entered for final suppression 621 s (10:21). The crew applied water for 23 s until the fire was extinguished. The total tactic time from the initial fire department intervention until the suppression crew entered the fire room was 169 s (2:49). The total water flowed was 151 gal for initial suppression, which does not include the water flowed during mop-up operations.

A single 1.75 in. hoseline with a combination nozzle set to straight stream was used for both interior and exterior suppression. No additional ventilation beyond the front door was established. The times and locations at which events and actions occurred in Experiment 10 are illustrated in Figure 3.117.

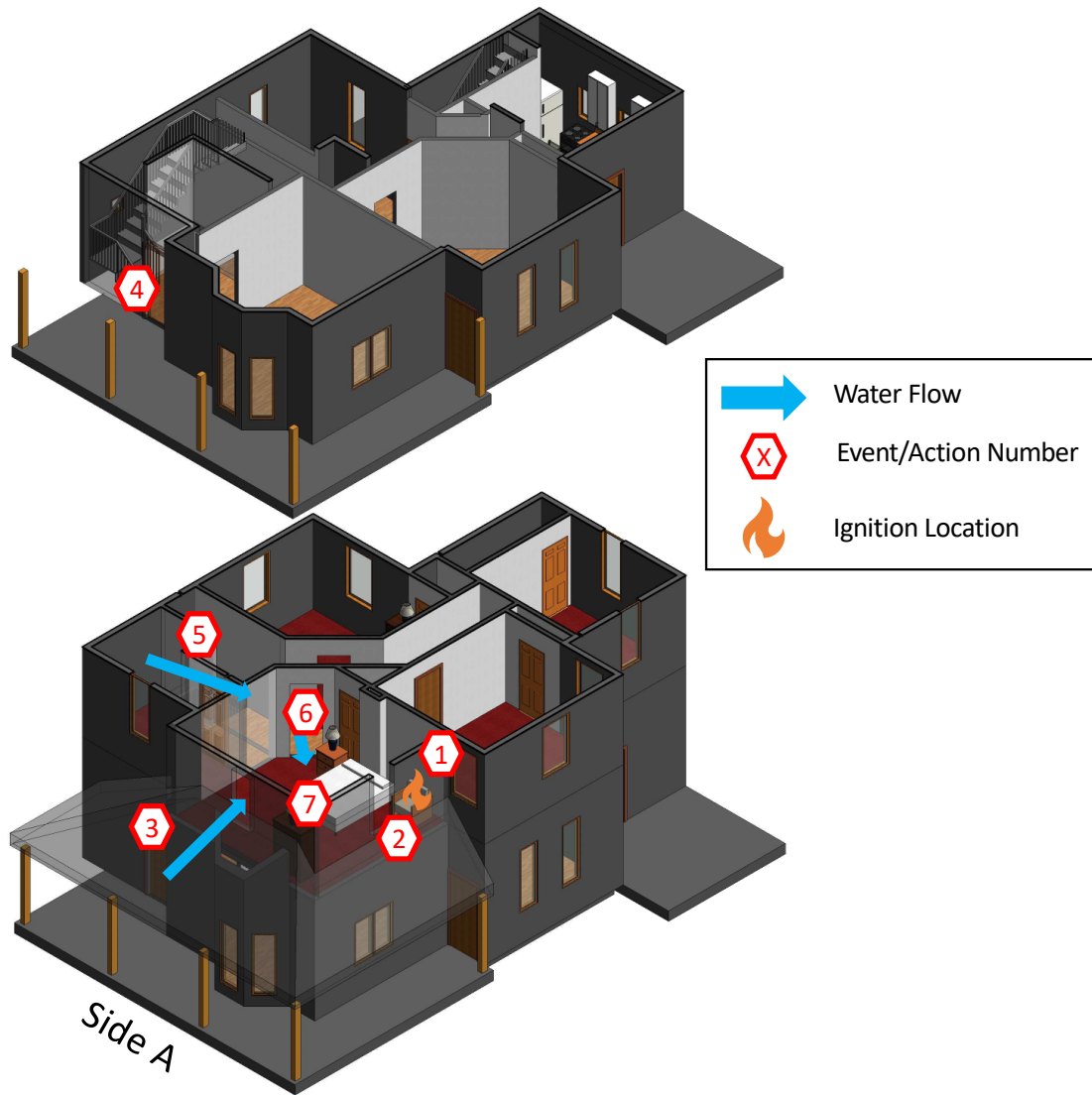

Action/Event	Time (mm:ss)	Time (s)
1 Ignition	00:00	0
2 Flashover	05:29	329
3 Exterior Water, Bedroom 1 Window	07:32	452
4 Front Door Open	07:44	464
5 Flow from Top of Stairs	09:01	541
6 Flow from Doorway	09:27	567
7 Suppression Crew Entered Fire Room	10:21	621

Figure 3.117: Time and sequence of actions and events for Experiment 10.

The fire room (bedroom 1) temperatures, shown in Figure 3.118, began to increase approximately 100 s post ignition as the fire began to spread beyond the upholstered chair where it was ignited.

As fire growth continued, fire began to extend out of the fire room windows 267 s post ignition and out the fire room doorway 274 s post ignition. The thermocouple data indicated the fire room transitioned through flashover 329 s post ignition. After this time, the temperatures within the fire room exceeded the listed calibration of the thermocouple wire, introducing a greater amount of uncertainty into the temperature measurements. The exterior suppression action (Action 3) reduced temperatures from post-flashover values. After exterior water application, the fire room temperatures gradually decreased until the initial interior suppression action, indicating the exterior suppression action did not completely extinguish the fire. Fire room temperatures began to decrease more rapidly after the stairway suppression action (Action 5). As suppression continued, fire room temperatures continued to decrease.

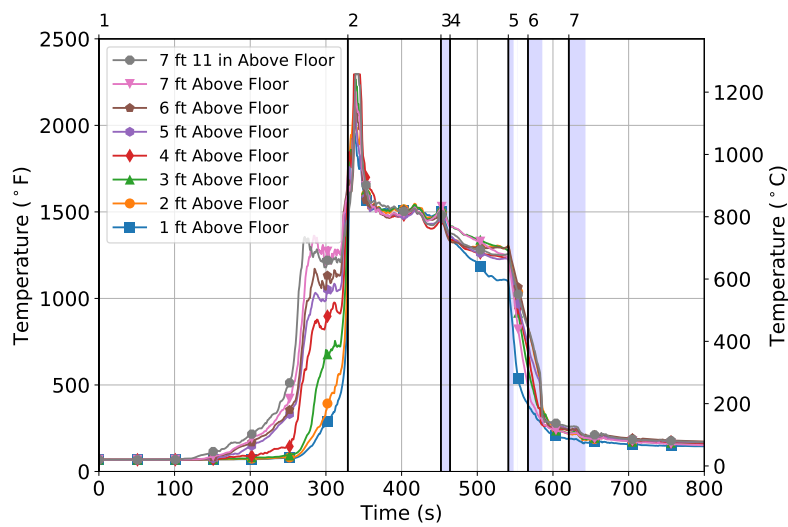

Action/Event	Time (s)
1 Ignition	0
2 Flashover	329
3 Exterior Water, Bedroom 1 Window	452
4 Front Door Open	464
5 Flow from Top of Stairs	541
6 Flow from Doorway	567
7 Suppression Crew Entered Fire Room	621

Figure 3.118: Fire room (bedroom 1) temperature data for Experiment 10. Blue vertical bars indicate time and duration of water flow.

The temperatures in the areas of the second-floor remote from the fire room (bedroom 1), shown in Figure 3.119, followed a similar trend to the fire room temperatures. The temperatures measured in the hallway directly outside the fire room (see Figure 3.119a), began to increase as smoke and fire began to extend into the hallway approximately 200 s post ignition. These temperatures reached a peak corresponding to flashover in the fire room. Temperatures remained steady until the time of fire department intervention, ranging from 210 °F 1 ft above the floor to 810 °F close to the ceiling. The exterior water application dropped the 7 ft 11 in. temperature to 390 °F. After reaching a local minimum value after exterior suppression, the 3 ft through 7 ft temperatures began to increase, while the 1 ft and 2 ft temperatures continued a gradual decrease. These trends reflect the fresh air being entrained into the fire room via the open front door and the subsequent growth of the fire prior to final, interior suppression. The 7 ft 11 in. temperature rebounded to 600 °F, but then the suppression action at the top of the stairway (Action 5) began to decrease temperatures. After the suppression crew began to flow water into the fire room from the doorway (Action 6), temperatures

permanently decreased.

As distance from the fire room increased, the magnitude of the temperatures decreased, and response to suppression actions were not as immediate. The temperatures farther down the hallway (see Figure 3.119b) and in bedroom 3 (see Figure 3.119c) both reflect the initial increase in temperatures following growth and subsequent decrease in temperatures prior to initial suppression. Because the door to bedroom 2 was closed throughout the experiment, the temperatures did not significantly increase during the experiment and are therefore not presented.

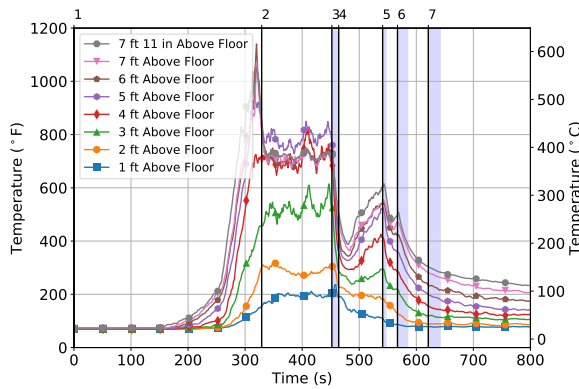

(a) Hallway Temperatures Outside Bedroom 1

Action/Event	Time (s)
1 Ignition	0
2 Flashover	329
3 Exterior Water, Bedroom 1 Window	452
4 Front Door Open	464
5 Flow from Top of Stairs	541
6 Flow from Doorway	567
7 Suppression Crew Entered Fire Room	621

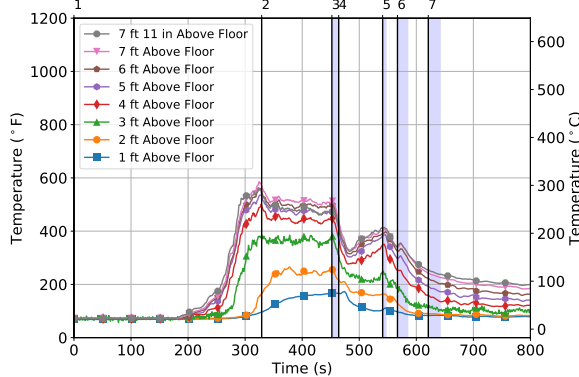

(b) Hallway Temperatures

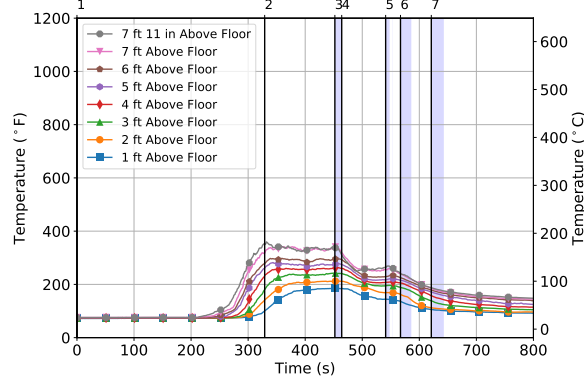

(c) Bedroom 3 Temperatures

Figure 3.119: Temperatures in open areas of second-floor of structure for Experiment 10. Blue vertical bars indicate time and duration of water flow.

Similar to the temperatures in the open areas of the second-floor, the hallway heat flux, measured at 1 ft and 3 ft elevations (see Figure 3.120a), and bedroom 3 heat flux, measured at a 1 ft elevation (see Figure 3.120b), began to increase as the fire room transitioned through flashover. The bedroom 3 heat flux was substantially less than the hallway heat flux, remaining under 2 kW/m^2 for the duration of the experiment. The peak heat fluxes in the hallway were measured prior to fire department intervention after the fire room had flashed over, and were 7.6 kW/m^2 and 3.2 kW/m^2 at 3 ft and 1 ft, respectively. The hallway heat fluxes initially decreased after exterior suppression to 2 kW/m^2 and 0 kW/m^2 at 3 ft and 1 ft, respectively. As the fire began to regrow, the heat fluxes

again increased to 4.0 kW/m^2 and 0.7 kW/m^2 before final suppression decreased the heat flux to negligible values approximately 600 s post ignition.

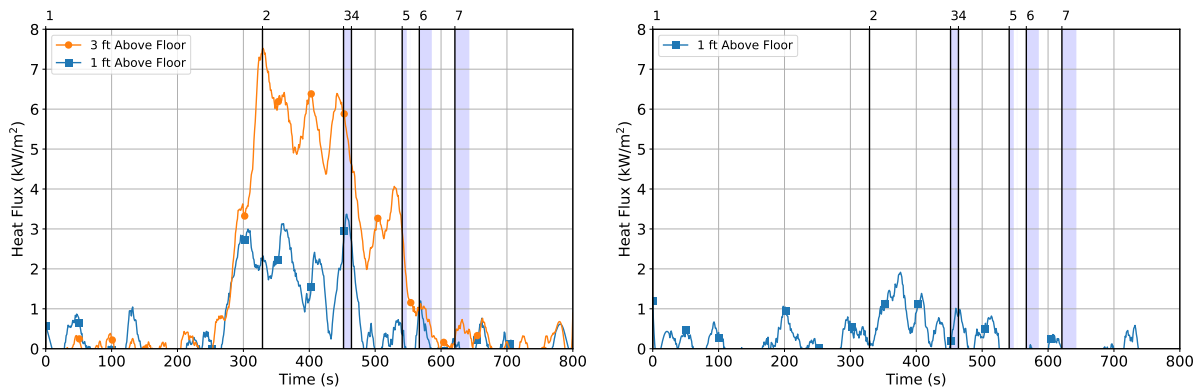

(a) Hallway Heat Flux

(b) Bedroom 3 Heat Flux

	Action/Event	Time (s)
1	Ignition	0
2	Flashover	329
3	Exterior Water, Bedroom 1 Window	452
4	Front Door Open	464
5	Flow from Top of Stairs	541
6	Flow from Doorway	567
7	Suppression Crew Entered Fire Room	621

Figure 3.120: Heat flux at remote locations for Experiment 10. Blue vertical bars indicate time and duration of water flow.

The pressure measurements taken in the fire room (bedroom 1) and adjacent areas of the second-floor (shown in Figure 3.121) provide insight into fire growth and flow changes during the experiment. The 7 ft pressure in the fire room increased first as the smoke layer in the fire room began to develop. The 4 ft pressure began to increase and the 1 ft pressure began to decrease below 0 Pa approximately 250 s post ignition, as bi-directional flow was established through the fire room windows and doorway. The pressure at the 7 ft and 4 ft elevations peaked at the time of flashover at 14 Pa and 5 Pa, respectively. These pressures were steadily decreasing prior to fire department intervention. The exterior water flow (Action 3) resulted in an increase in the 1 ft and 4 ft pressure. Following the exterior flow, the pressures at all three elevations steadily increased, indicating re-growth of the fire during this period. As the suppression crew advanced up the stairs and continued suppression from the stairway and fire room doorway, the pressures in the fire room converged to 0 Pa.

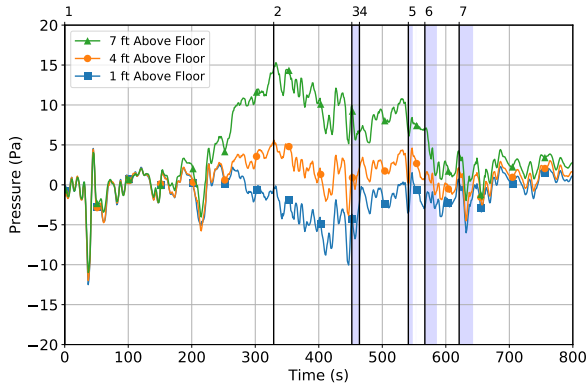

(a) Fire Room (Bedroom 1) Pressure

Action/Event	Time (s)
1 Ignition	0
2 Flashover	329
3 Exterior Water, Bedroom 1 Window	452
4 Front Door Open	464
5 Flow from Top of Stairs	541
6 Flow from Doorway	567
7 Suppression Crew Entered Fire Room	621

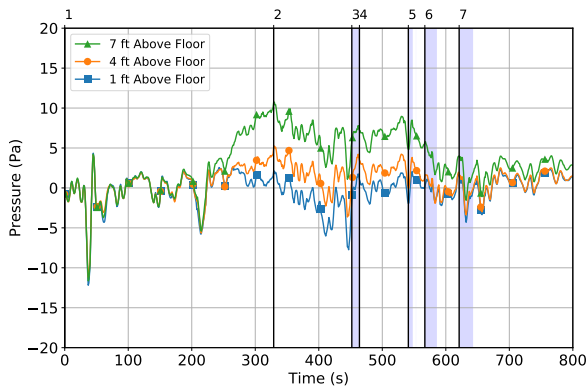

(b) Hallway Pressure

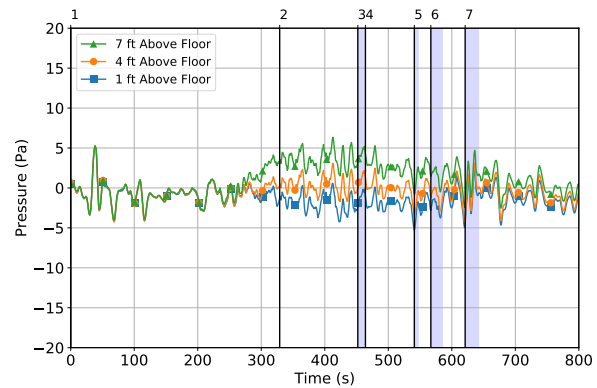

(c) Bedroom 3 Pressure

Figure 3.121: Pressures in second-floor of structure for Experiment 10. Blue vertical bars indicate time and duration of water flow.

The pressures in the hallway (see Figure 3.121b) and bedroom 3 (see Figure 3.121c) followed a similar trend to the fire room (bedroom 1) pressures, although the magnitude of the pressures in these locations were less than in the fire room. As the fire grew, a bi-directional flow was established through the fire room doorway (see Figure 3.122a). Hot gases flowed out of the fire room into open spaces on the second-floor, and fresh air was entrained into the fire room.

As the fire consumed the available oxygen within the structure, the primary source of oxygen for combustion came from the fire room windows. After exterior water flow and front door ventilation, a new flow path was established (see Figure 3.122b). Fresh air was entrained through the front door, up the stairs, and into the fire room. This further decreased temperatures close to the floor at the top of the stairs while contributing to the regrowth of the fire.

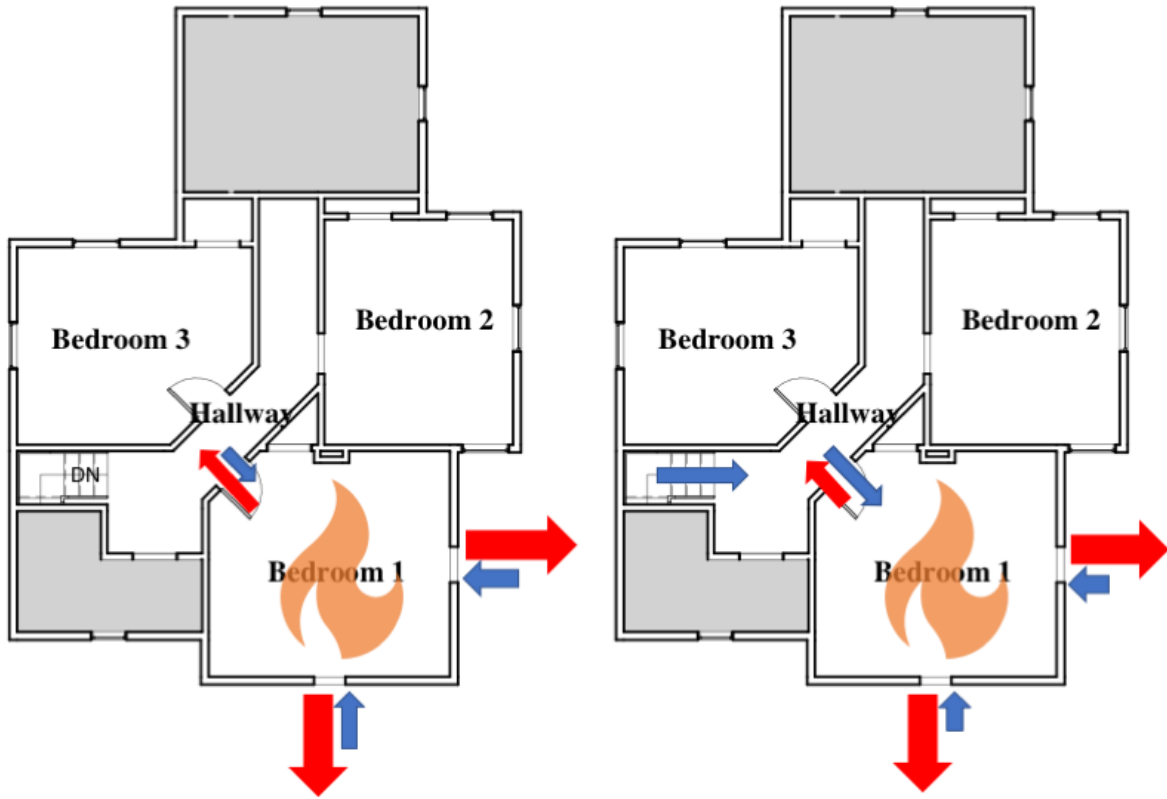

(a) Flows Prior to Front Door being Opened

(b) Flows After Front Door was Opened

Figure 3.122: Changes in flow during Experiment 10 as a function of firefighter ventilation. Red arrows indicate flow out of the compartment, blue arrows indicate entrainment into the compartment, and the sizes of the arrows indicate the relative magnitude of the flow through each opening.

Gas concentrations were measured in the same locations as heat flux: 1 ft and 3 ft elevations in the hallway, and 1 ft above the floor in bedroom 3 (see Figure 3.123). Visibility in the hallway and bedroom 3 cameras decreased approximately 260 s post ignition. Shortly after, O_2 decreased and CO and CO_2 increased at the hallway location as shown in Figure 3.123a. The O_2 concentration 1 ft above the floor remained close to pre-ignition conditions, which is indicative of the fresh air entrained into the fire room. The concentration of CO and CO_2 were similarly near ambient. The 3 ft elevation concentrations were greater, reaching peaks of 11.3% for both O_2 and CO_2 , and 1.9% for CO at the time of fire department intervention. The combination of the exterior suppression and front door ventilation caused the O_2 concentration to increase and the CO_2 and CO concentrations to decrease as fresh air from the newly created flow path traveled past the hallway location. In the remote location, bedroom 3, there was negligible change in gas concentration as shown in Figure 3.123b.

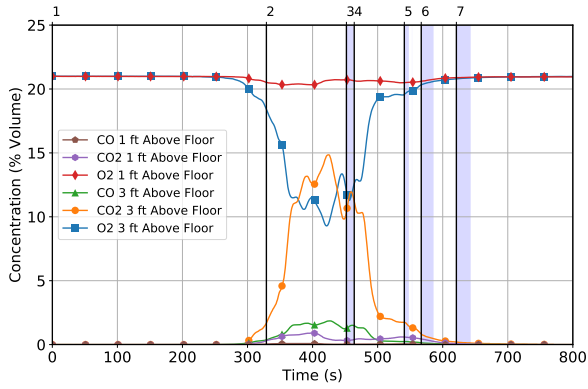

(a) Hallway Gas Concentrations

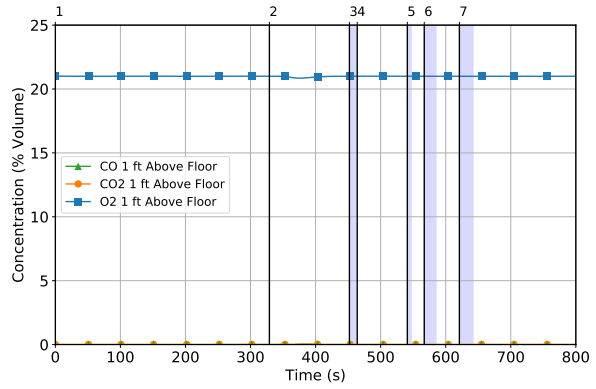

(b) Bedroom 3 Concentrations

	Action/Event	Time (s)
1	Ignition	0
2	Flashover	329
3	Exterior Water, Bedroom 1 Window	452
4	Front Door Open	464
5	Flow from Top of Stairs	541
6	Flow from Doorway	567
7	Suppression Crew Entered Fire Room	621

Figure 3.123: Gas concentrations in the hallway and in bedroom 3 for Experiment 10.

3.11 Experiment 11 — Exterior Fire Control with Positive Pressure Ventilation

Experiment 11 was conducted to examine positive pressure ventilation after the initial exterior water application (Coordination Method 3). At 230 North Walnut Street in Sidney, Ohio, a two-story, 2,074 sq ft wood frame structure was instrumented to conduct this second-floor bedroom fire experiment. The four exterior sides of the structure appear in Figure 3.124. The structure was stick-built with rough cut lumber framing with wood-vinyl siding. The foundation was a combination of brick and concrete block. The peaked roof was constructed using 1 in.-by-6 in. sheathing covered with asphalt shingles. Detailed dimensioned drawings for the first and second story appear in Appendix Figures B.3 and B.4, respectively.



(a) Side A



(b) B/C Corner



(c) Side C



(d) Side D

Figure 3.124: Exterior photographs of the structure for Experiment 11.

The first-floor contained an entry way, living room, family room, dining room, and kitchen. The second-floor contained three bedrooms with a common hallway. The side A stairwell connected the two floors. These areas defined the experimental volume of the structure. A second-floor

bathroom, bedroom, and rear stairway were isolated and utilized as instrumentation space. The structure was instrumented for temperature, pressure, heat flux, IR, and standard video to capture the fire dynamics during experimentation. Instrumentation was also installed to characterize the potential for skin burns and occupant toxic exposure during the experiment. Figure 3.125 shows the layout of the first and second-floors with the instrumentation locations.

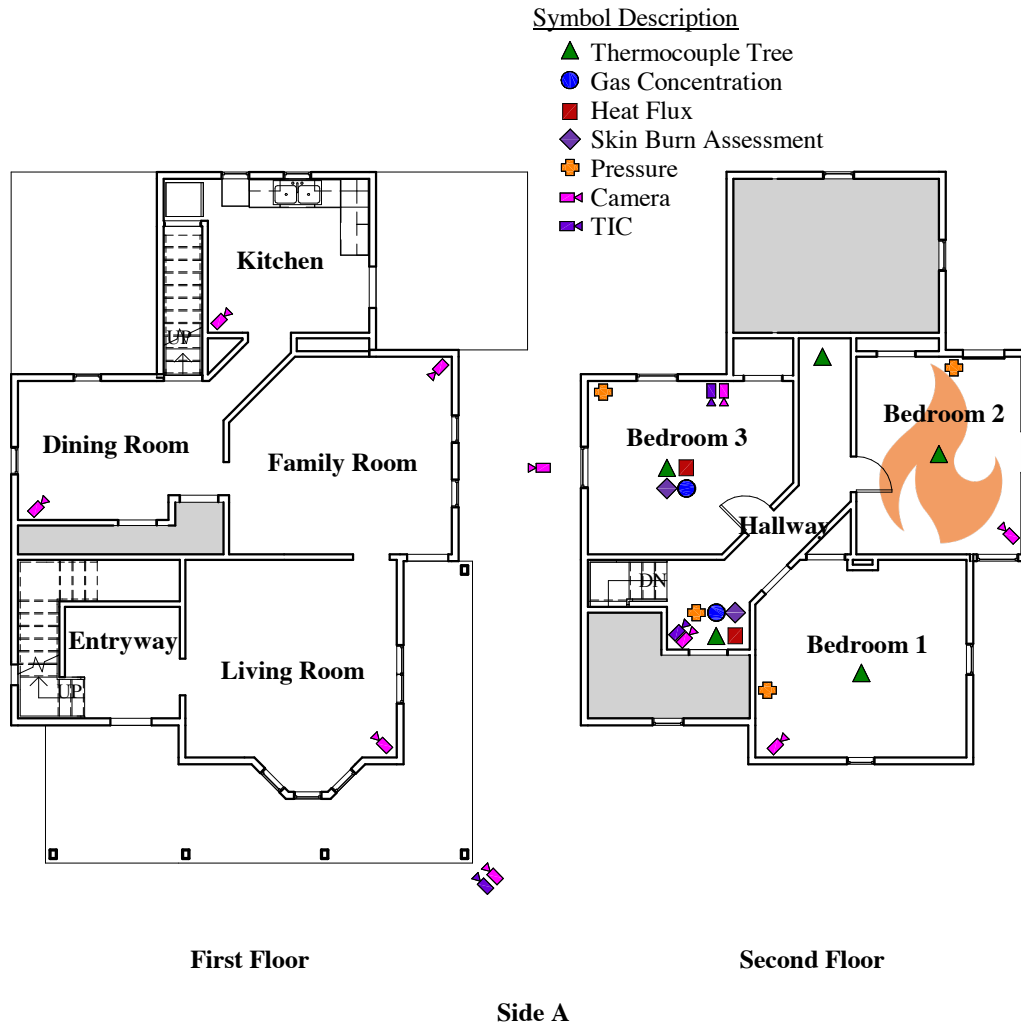

Figure 3.125: Instrumentation and floor plan for Experiment 11. The gray areas were isolated from the remainder of the structure and utilized as space for instrumentation.

The fire room (bedroom 2) was furnished with the bedroom fuel package described in Section 2.4.1. Photographs of the fire room prior to ignition are presented in Figure 3.126. A dimensioned layout of the fire room is included in Figure 3.127.

To replicate a similar volume of space found in other experiments, bedroom 1 remained closed throughout the experiment. To allow for repeatable fire growth, the windows located on side A and

side D (labeled 15 and 16 in Figure 3.127) were removed prior to ignition.



(a) A/B Corner



(b) Side C Wall



(c) C/D Corner Wall



(d) A/D Corner

Figure 3.126: Interior photographs of fire room for Experiment 11.

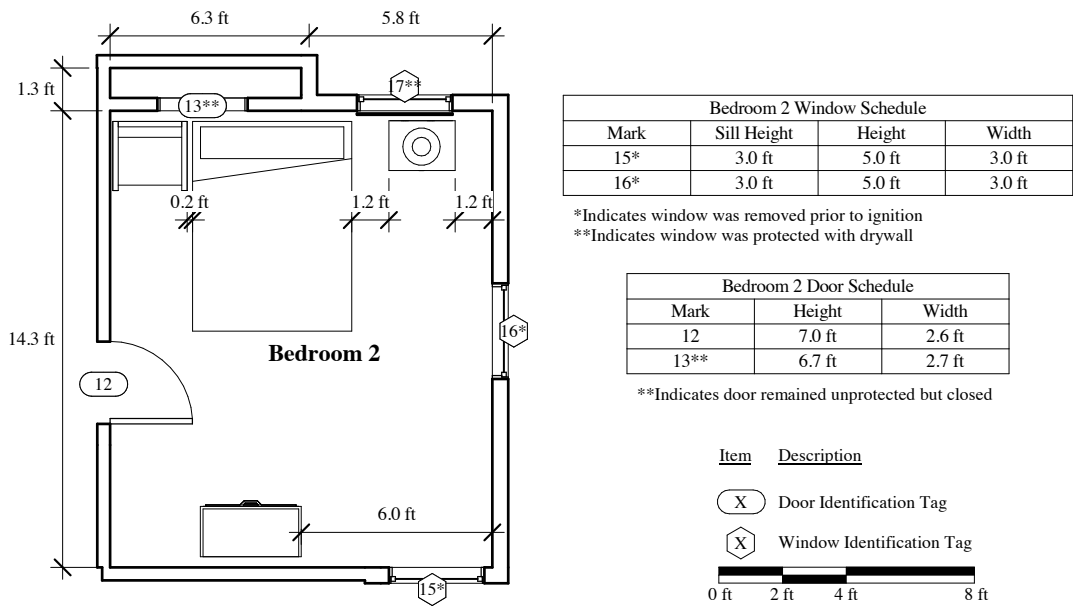

Figure 3.127: Fire room layout for Experiment 11.

The fire was ignited in the upholstered chair next to the mattress in the fire room ($t = 0$ s). Flames were first visible from the side D window 296 s (4:56) post ignition. The fire continued to grow reaching flashover with two windows of visible fire 321 s (5:21) post ignition. Fire department intervention began after the fire transitioned into a post-flashover steady state.

The initial fire department intervention was exterior water flow with a secondary hoseline through the side A window. The suppression was initiated 451 s (7:31) post ignition and had a duration of 12 s. A ventilation crew opened the front door 469 s (7:49) post ignition. The PPV fan was turned on prior to the front door opening and was positioned at the doorway at 476 s (7:54) post ignition. While the suppression crew switched to the primary hoseline, a secondary back-up crew briefly applied water to suppress exterior flames 476 s (7:56) post ignition. Water was directed at the eaves for 6 s.

The suppression crew then entered the structure with the primary hoseline and advanced up the stairs to the second-floor. After moving down the hallway, the first interior water flow application occurred from the fire room (bedroom 2) doorway 549 s (9:09) post ignition. The initial interior water flow lasted 9 s in duration. The suppression crew entered the fire room for final extinguishment 577 s (9:37) post ignition where there were two interior water flow applications occurred of 7 s and 8 s in duration. The entire tactic time, from initial exterior water flow to fire room entry, was 126 s (2:06). The total water flowed for initial suppression was 105 gal, 68 gal flowed from the primary hoseline and 37 gal from the secondary hoseline. The total water flowed for initial suppression did not include water flowed during mop-up operations.

Two 1.75 in. hoselines both with a combination nozzle, set to straight stream, were utilized for interior and exterior suppression. The primary hoseline was placed on side A and advanced into

the house for interior suppression. The secondary hoseline was placed on side D and used for exterior suppression. A gas-powered fan³ was used to for positive pressure ventilation. The times and locations of the actions and events conducted during Experiment 11 are shown on the isometric diagram presented in Figure 3.128.

³Manufacturer specifications: 18 in. diameter, gas-powered, 14,773 CFM.

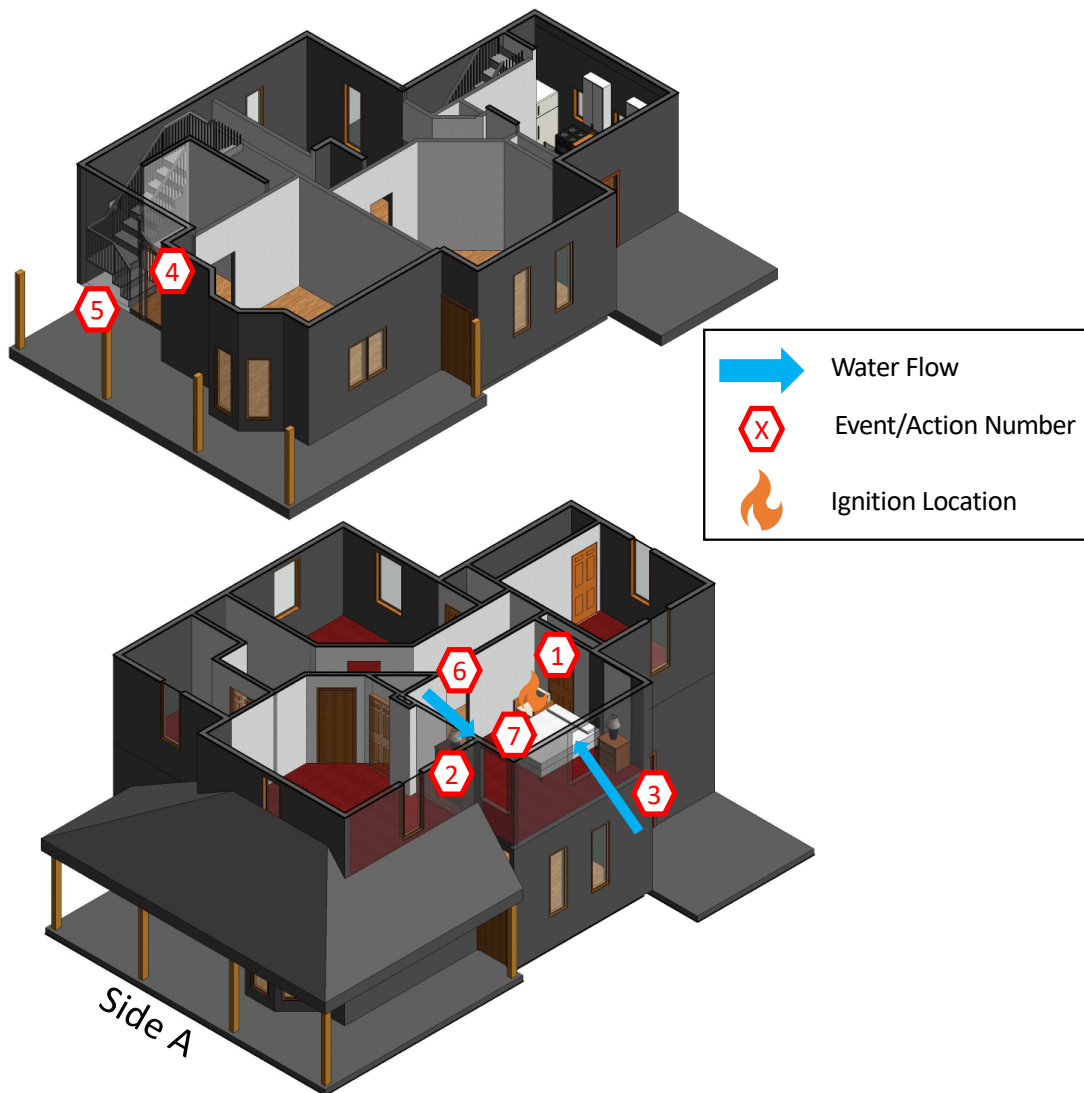

Action/Event	Time (mm:ss)	Time (s)
1 Ignition	00:00	0
2 Flashover	05:21	321
3 Exterior Water, Bedroom 2 Window	07:31	451
4 Front Door Open	07:49	469
5 PPV Fan Turned In	07:56	476
6 Flow from Doorway	09:09	549
7 Suppression Crew Entered Fire Room	09:37	577

Figure 3.128: Time and sequence of actions and events for Experiment 11.

Temperatures in the fire room (bedroom 2) are presented in Figure 3.129. Fire room temperatures started to increase approximately 100 s post ignition as the fire began to spread beyond the uphol-

stered chair to the mattress. Fire was first observed from the fire room windows 296 s post ignition. The fire room transitioned through flashover 321 s post ignition. After flashover, the temperatures in the fire room exceeded the listed calibration of the thermocouple wire, introducing a greater degree of uncertainty to the temperature measurements. The fire remained in a post-flashover state until the initial exterior water application (Action 3). The exterior water application damaged the thermocouples, so after this point the data were omitted from this location.

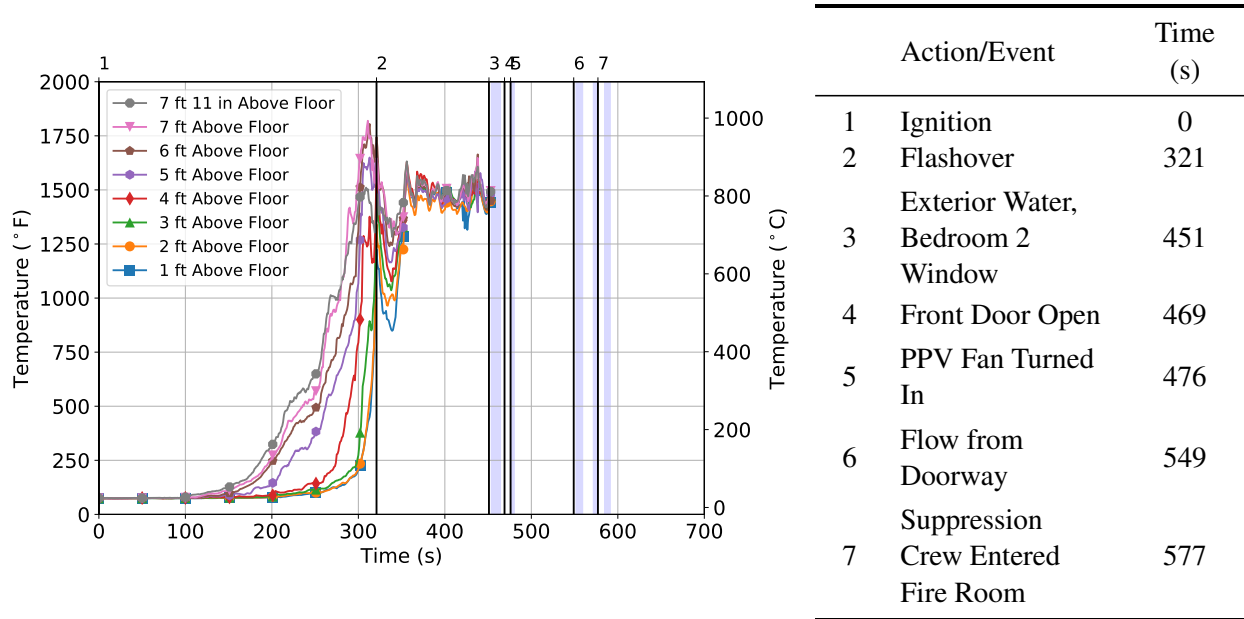
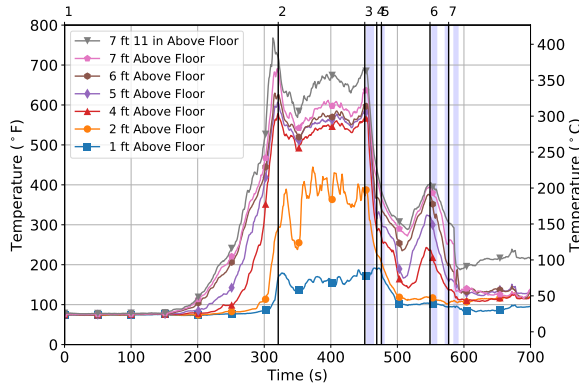

Figure 3.129: Fire room (bedroom 2) temperature data for Experiment 11. Blue vertical bars indicate time and duration of water flow.

Temperatures outside the fire room (see Figure 3.130) first began to increase approximately 150 s post ignition as the smoke layer in the fire room descended causing products of combustion to spill into the hallway. The hallway temperatures located outside the fire room (see Figure 3.130a) reached a peak corresponding with flashover in the fire room. Temperatures in the hallway remained relatively steady in the period leading up to fire department intervention. The exterior suppression action caused the temperatures to drop from between 375 °F to 685 °F, to below 285 °F. Meanwhile, the 1 ft temperature briefly increased from 165 °F to 190 °F then decreased below 90 °F. After the initial temperature decrease from exterior suppression, temperatures in the hallway began to increase again approximately 515 s post ignition, and continued to increase until suppression occurred from the fire room doorway (Action 6) 549 s post ignition. Temperatures decreased as suppression continued in the fire room, with another significant drop occurring 589 s post ignition as suppression was occurring in the fire room.



(a) Hallway Temperature between Bedroom 2 and Bedroom 3

Action/Event	Time (s)
1 Ignition	0
2 Flashover	321
3 Exterior Water, Bedroom 2 Window	451
4 Front Door Open	469
5 PPV Fan Turned In	476
6 Flow from Doorway	549
7 Suppression Crew Entered Fire Room	577

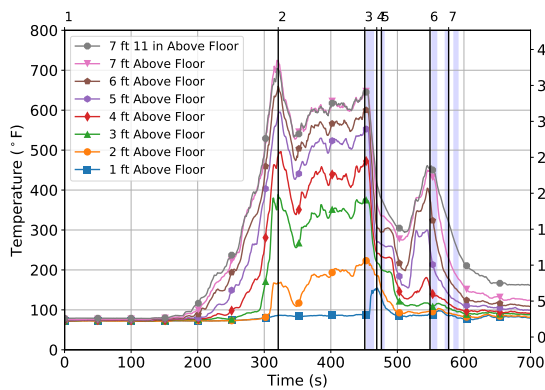

(b) Hallway Temperature outside Bedroom 1

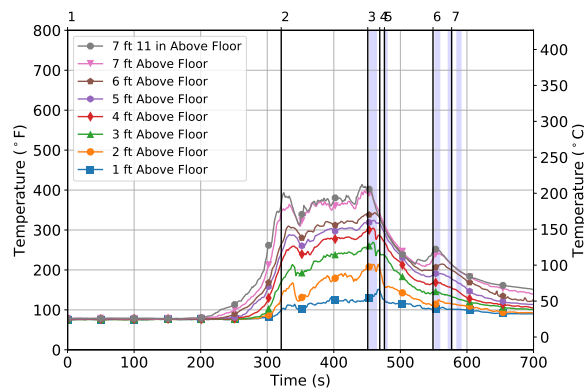

(c) Bedroom 3 Temperatures

Figure 3.130: Temperatures in open areas of second-floor of structure for Experiment 11. Blue vertical bars indicate time and duration of water flow.

The temperature locations more remote from the fire room (bedroom 2), the hallway temperatures outside bedroom 1 (see Figure 3.130b), and the bedroom 3 temperatures (see Figure 3.130c) followed a similar trend to the hallway temperatures outside the fire room, reaching a peak close to the time of flashover. The exterior suppression action (Action 3) decreased the 2 ft through 7 ft 11 in. temperatures at both measurement locations, while the 1 ft temperatures at both locations increased. In bedroom 3, this increase was fairly insignificant, with the 1 ft temperature increasing from 132 °F to 151 °F, but in the remote hallway location the temperature increased from 89 °F to 154 °F. The regrowth in temperatures observed approximately 515 s post ignition was also observed in bedroom 3 and the remote hallway thermocouple locations. The 7 ft 11 in. temperatures increased to local peaks of 465 °F and 250 °F for the remote hallway and bedroom 3, respectively. As the suppression crew began flowing water from the fire room doorway, the temperatures at each of these locations began to decrease permanently.

Heat flux was measured at 1 ft and 3 ft elevations in the hallway (see Figure 3.131a) and 1 ft above the floor in bedroom 3 (see Figure 3.131b). The hallway heat fluxes followed a similar trend to the temperatures at this location. The 3 ft heat flux was significantly greater than the 1 ft heat flux for

the duration of the experiment. The 3 ft heat flux first started to increase shortly before flashover. It peaked to 6 kW/m² at the time of exterior suppression, after which the heat flux decreased below 2 kW/m². The heat flux increased at the same time that temperatures throughout the second-floor started to increase, before fire room doorway suppression permanently reduced the 3 ft heat flux.

The 1 ft heat flux in the hallway remained under 2 kW/m² for the majority of the experiment, with the exception of a peak of 3 kW/m², which occurred simultaneous with the exterior water application and mirrored the temperature increase at 1 ft at this location. The 1 ft heat flux in bedroom 3 remained under 2 kW/m² for the duration of the experiment. A spike in heat flux coincident with suppression was not observed.

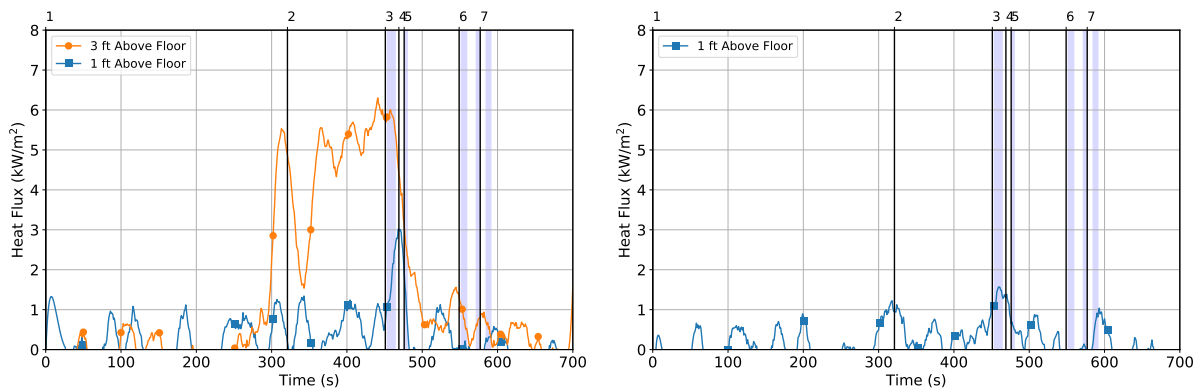

(a) Hallway Heat Flux

(b) Bedroom 3 Heat Flux

Action/Event	Time (s)
1 Ignition	0
2 Flashover	321
3 Exterior Water, Bedroom 2 Window	451
4 Front Door Open	469
5 PPV Fan Turned In	476
6 Flow from Doorway	549
7 Suppression Crew Entered Fire Room	577

Figure 3.131: Heat flux at remote locations for Experiment 11. Blue vertical bars indicate time and duration of water flow.

As the fire grew and a smoke layer began to develop, the 7 ft pressure in the fire room began to increase approximately 150 s post ignition, as shown in Figure 3.132a. As the fire continued to spread to other objects in the fire room (bedroom 2) and become ventilation limited, the 4 ft pressure also began to increase, while the 1 ft pressure began to decrease. This indicates a bi-directional flow was established in the fire room windows and doorway. This pressure profile was maintained until exterior suppression (Action 3), which caused all pressures to approach ambient conditions. The activation of the PPV fan 7 s after the front door was opened caused the pressure at all three elevations in the fire room to increase above zero. The fire room pressures began to increase more quickly as the fire began to regrow before suppression in the fire room caused the

pressure to converge.

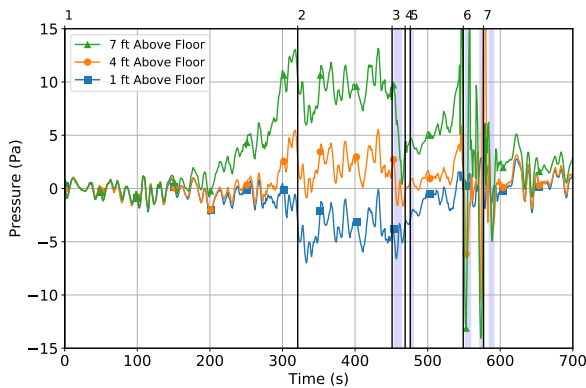

(a) Bedroom 2 Pressure

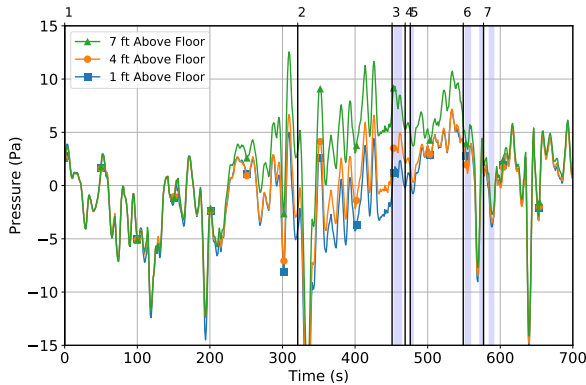

(b) Hallway Pressure

	Action/Event	Time (s)
1	Ignition	0
2	Flashover	321
3	Exterior Water, Bedroom 2 Window	451
4	Front Door Open	469
5	PPV Fan Turned In	476
6	Flow from Doorway	549
7	Suppression Crew Entered Fire Room	577

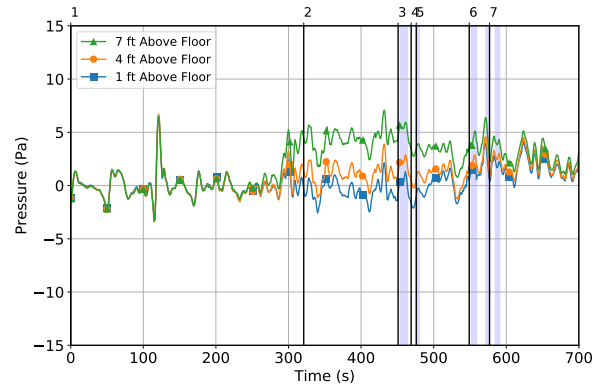

(c) Bedroom 3 Pressure

Figure 3.132: Pressures in second-floor of structure for Experiment 11. Blue vertical bars indicate time and duration of water flow.

Generally, the remote pressures followed a similar trend to the fire room pressures, maintaining positive 7 ft and 4 ft pressures and negative 1 ft pressure. The pressures uniformly increased above 0 Pa at the time of exterior suppression, and continued to increase after the PPV fan was activated. A local peak was reached as the suppression crew began suppression from the fire room doorway. After which, the hallway pressures converged to 0 Pa.

Although the pressures in bedroom 3 followed a similar trend to the hallway location, these pressures did not fluctuate as much as those in the hallway. The increase in pressure, observed after the PPV fan was activated, was not as significant since this location was remote from the flow path. Data presented in Figure 3.132 shows the magnitude of the pressures decreased as the distance from the fire room increased. This indicates fresh air flowed from these remote locations toward the fire room at the 1 ft elevation, while hot gases were exhausted from the fire room to these remote locations at the 4 ft and 7 ft elevations.

The pressures presented in Figure 3.132 lend insight into the changes in flow over the course of

the experiment, which are illustrated in Figure 3.133. As the fire became ventilation limited, bi-directional flows were established in the two fire room (bedroom 2) windows and doorway (see Figure 3.13a). The fire room windows exhausted hot gases through the top portion and entrained fresh air from the lower portion. The fire room doorway expelled hot gases to remote parts of the second-floor through the top portion, replacing fresh air through the lower part. After the front door was opened, fresh air was entrained and hot gases were expelled through this additional ventilation opening (see Figure 3.133b). As a result, less fresh air was entrained through the fire room windows, allowing more exhaust to escape. After the fan was turned into the doorway, fresh air was forced into the structure (see Figure 3.133c). PPV at the front door forced exhaust to escape only through the fire room windows.

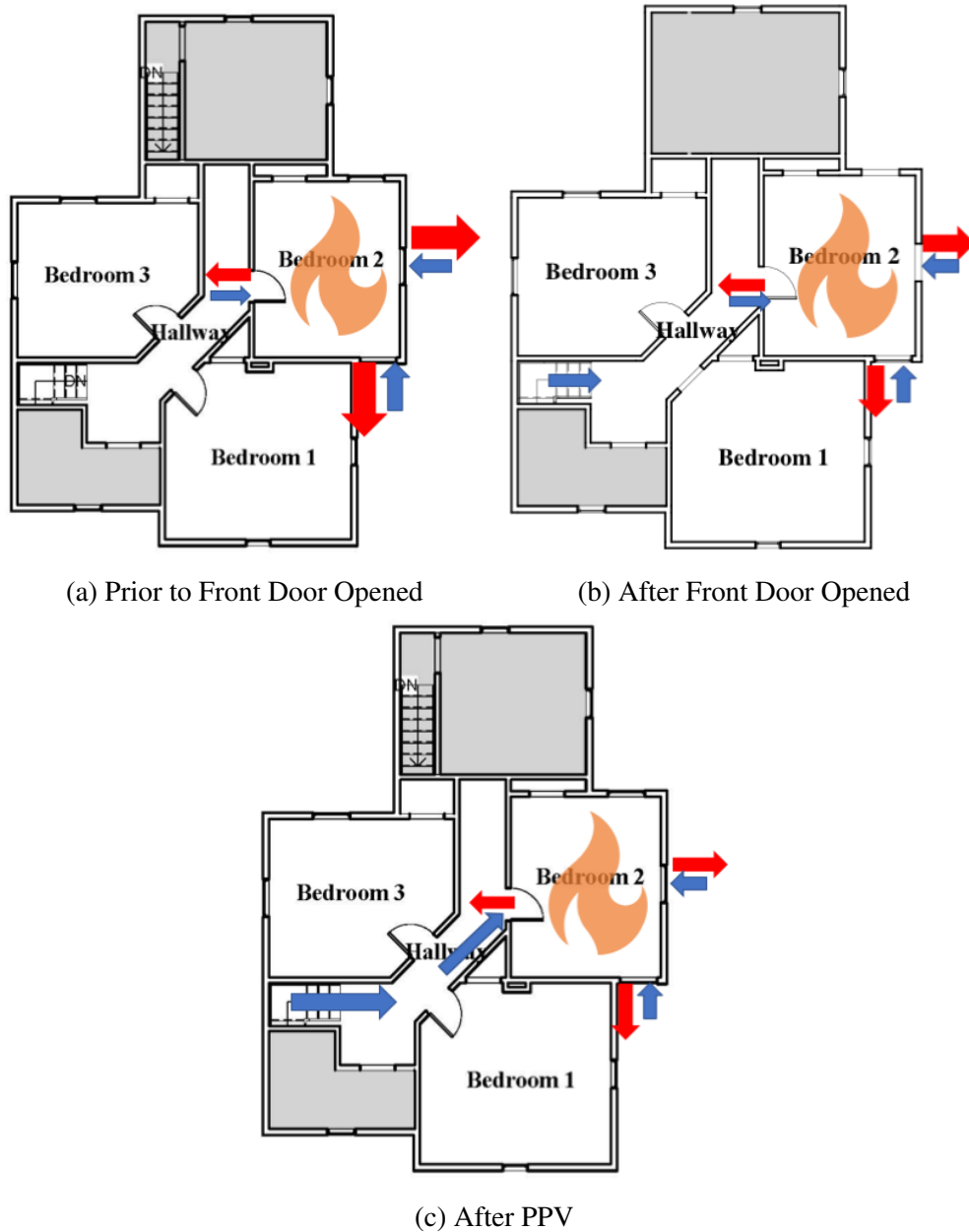

Figure 3.133: Changes in flow during Experiment 11. Red arrows indicate flow out of the compartment, blue arrows indicate entrainment into the compartment, and the sizes of the arrows indicate the relative magnitude of the flow through each opening.

When exterior suppression was initiated, a burst of gases was observed rolling down the hallway from the fire room to the top of the stairs. Figure 3.134 shows this phenomenon, which lasts for approximately 15 s and corresponds with the rise in 1 ft temperatures in Figures 3.130b and 3.130c and the hallway gas concentrations discussed in the following paragraph. It is unclear what caused this movement of gases, although it is possibly a result of steam production in the fire room (bedroom 2) as the exterior stream cooled the hot plaster ceiling. The opening of the front door and

subsequent activation of the PPV fan (see Figure 3.133c) created a new flow path, establishing a high-pressure front in the hallway. Because the exterior suppression action reduced the size of the fire, this allowed the fire room doorway to provide mostly inflow to the fire room and the fire room windows to mostly exhaust the hot gases. The entrained air provided by the fan also aided the growth of the fire prior to the interior suppression actions from the fire room doorway and fire room itself.

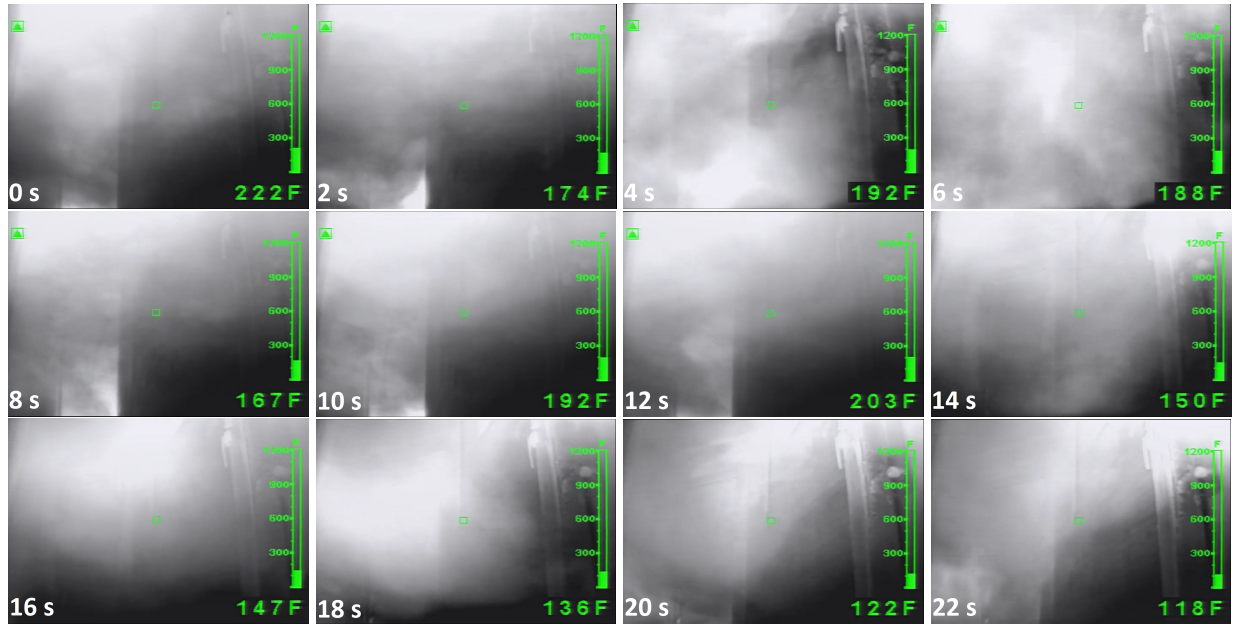
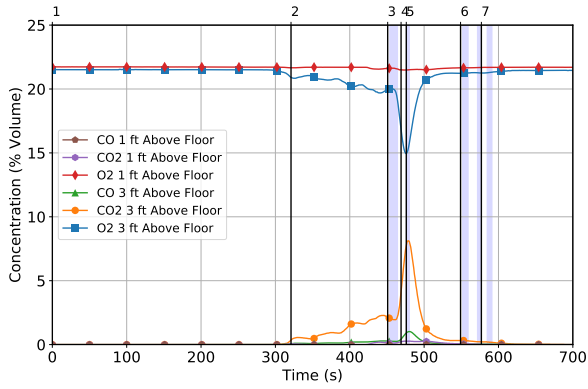
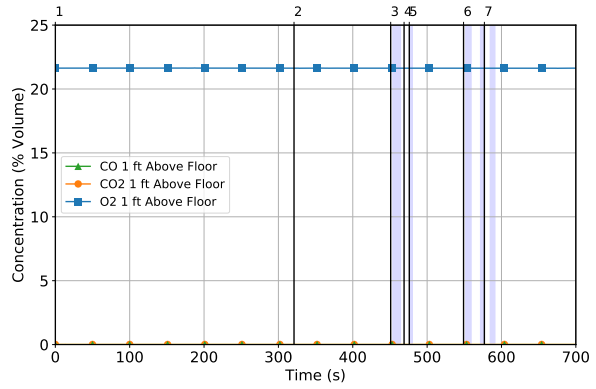

Figure 3.134: Time lapse of thermal camera in remote hallway location for Experiment 11. Shows movement of products of combustion down the hallway from the fire room to the top of the stairs. Still images are shown every 2 s from the start of the smoke movement.

Gas concentrations were measured at the same locations as heat flux: 1 ft and 3 ft above the floor in the hallway, and 1 ft above the floor in bedroom 3 (see Figure 3.135). The 1 ft gas concentrations at both of these locations remained approximately ambient for the duration of the experiment, although visibility was lost at both locations approximately 315 s post ignition. At approximately the time of visibility loss, the 3 ft O₂ began to decrease and the CO₂ and CO began to increase. During the exterior suppression action, the O₂, CO₂, and CO concentrations were 20%, 2%, and 1%, respectively. The movement of products of combustion down the hallway caused the 3 ft gas concentrations to peak, decreasing the O₂ concentration to 15% and increasing the CO₂ and CO to 8% and 1%, respectively. The opening of the front door and the activation of the PPV fan caused these concentrations to sharply return to pre-ignition conditions, and they trended toward ambient for the remainder of the experiment.



(a) Hallway Gas Concentrations



(b) Bedroom 3 Gas Concentrations

	Action/Event	Time (s)
1	Ignition	0
2	Flashover	321
3	Exterior Water, Bedroom 2 Window	451
4	Front Door Open	469
5	PPV Fan Turned In	476
6	Flow from Doorway	549
7	Suppression Crew Entered Fire Room	577

Figure 3.135: Gas concentrations at remote locations for Experiment 11. Blue vertical bars indicate time and duration of water flow.

3.12 Experiment 12 — Exterior Fire Control with Additional Horizontal Ventilation

Experiment 12 was designed to examine additional horizontal ventilation after the initial exterior water application. At 230 North Walnut Street in Sidney, Ohio, a two-story, 2,074 sq ft wood frame structure was instrumented to conduct this second-floor bedroom fire experiment. The four exterior sides of the structure appear as photographs presented in Figure 3.136. The structure was stick-built with rough cut lumber framing with wood-vinyl siding. The foundation was a combination of brick and concrete block. The peaked roof was constructed using 1 in.-by-6 in. sheathing covered with asphalt shingles. Detailed dimensioned drawings for the first and second story appear in Appendix Figures B.3 and B.4, respectively.



(a) Side A



(b) B/C Corner



(c) Side C



(d) Side D

Figure 3.136: Exterior photographs of the structure for Experiment 12.

The first-floor contained an entry way, living room, family room, dining room, and kitchen. The second-floor contained three bedrooms and a common hallway. A stairwell located in the A/B corner connected the two floors. These areas defined the experimental volume of the structure. A

second-floor bedroom, bathroom, and rear stairway were isolated and utilized as instrumentation space. The structure was instrumented for temperature, pressure, heat flux, IR, and standard video to capture the fire dynamics during experimentation. Instrumentation was also installed to characterize the potential for skin burns and occupant toxic exposure during the experiment. Figure 3.137 shows the layout of the first and second-floors with the instrumentation locations.

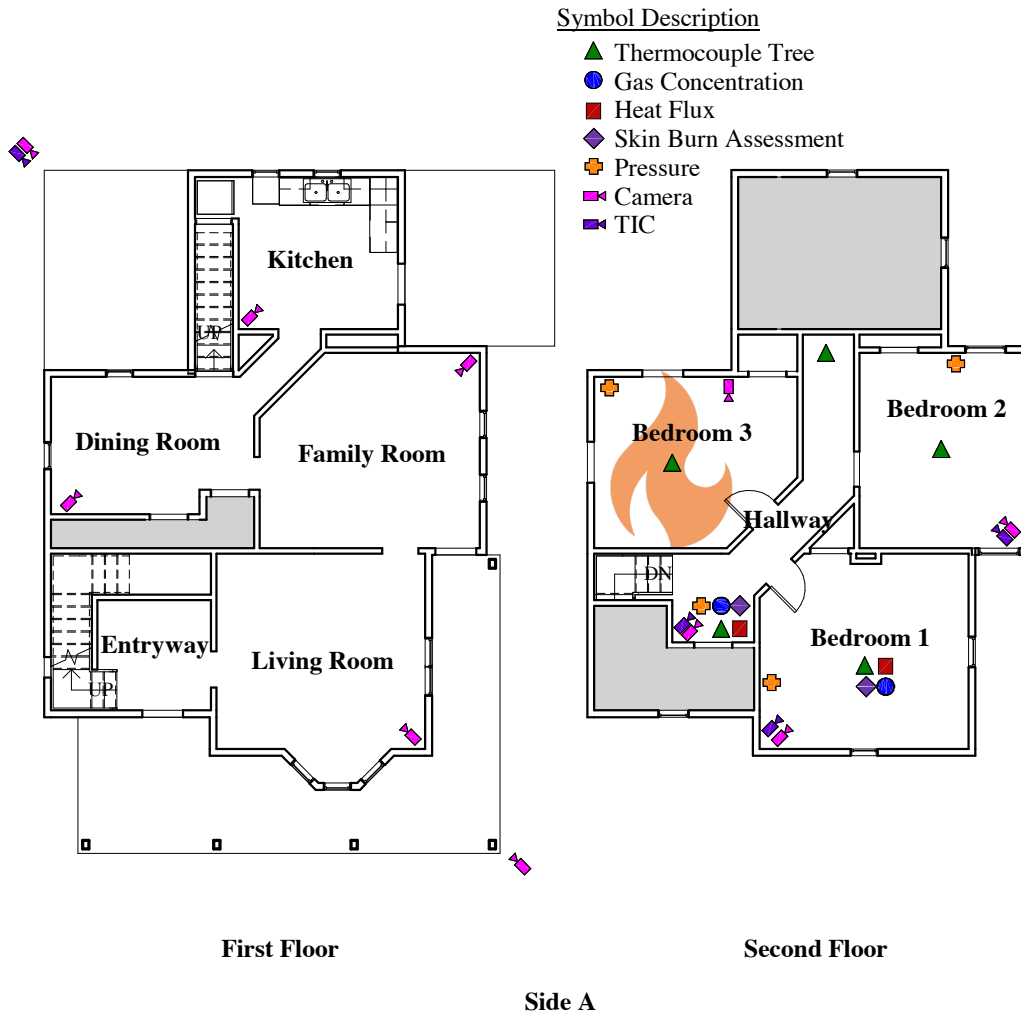

Figure 3.137: Instrumentation and floor plan for Experiment 12. The gray areas were isolated from the remainder of the structure and utilized as space for instrumentation.

The fire room (bedroom 3) was furnished with the bedroom fuel package described in Section 2.4.1. Photographs of the fire room prior to ignition are presented in Figure 3.138. A dimensioned layout of the fire room is included in Figure 3.139.

To replicate a similar volume of space found in other experiments, bedroom 2 remained closed throughout the experiment. To allow for repeatable fire growth, the side B and side C windows

(labeled 20 and 21 in Figure 3.127) were removed prior to ignition.



(a) A/B Corner



(b) B/C Corner



(c) A/D Corner

Figure 3.138: Interior photographs of fire room for Experiment 12.

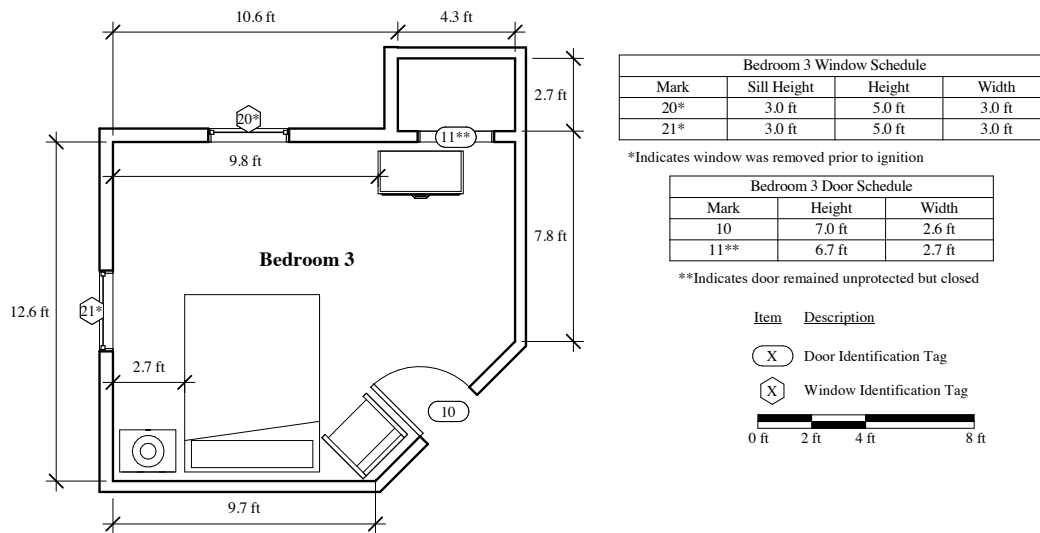

Figure 3.139: Fire room layout for Experiment 12.

The fire was ignited in the upholstered chair located adjacently to the mattress ($t = 0$ s). Flames were first visible from the side B window 210 s (3:30) post ignition. The fire continued to grow, producing flames from the side C window 232 s (3:52) post ignition. The fire receded from the side C window 112 s later, 344 s (5:44) post ignition. Flashover occurred 275 s (4:35) post ignition and the fire transitioned into a post-flashover state before any fire department intervention occurred.

The initial fire department intervention was the exterior water application from the secondary hose-line through the side B window. The exterior suppression was initiated 421 s (7:01) post ignition and lasted 10 s. As the suppression crew finished this exterior water application, the front door was opened and all windows on the second-floor were simultaneously ventilated 435 s (7:15) post ignition. The suppression crew then entered the structure and advanced with the primary hoseline up the stairs to the second-floor. The suppression crew moved down the hallway and initiated interior water flow from the fire room doorway 516 s (8:36) post ignition. The initial interior water application started in the fire room doorway, lasting 27 s. The crew entered the fire room at 533 s (8:53) post ignition while flowing water. Final suppression inside the fire room occurred at 547 s (9:07) post ignition. Three additional interior water flow applications occurred lasting 15 s, 27 s, and 15 s. The entire tactic time, from exterior water flow to fire room entry, was 112 s (1:52). The total water flowed for initial suppression was 182 gal, 162 gal from the primary hoseline and 20 gal from the secondary hoseline. The total water flowed for initial suppression does not include water flowed during mop-up operations.

Two 1.75 in. hoselines with combination nozzles set to straight stream, were used for interior and exterior suppression. The primary hoseline was placed on side A and advanced into the structure for interior suppression. The secondary hoseline was placed on side B and used for exterior suppression. Additional ventilation was provided by opening all windows on the second-floor. The times and locations of the actions and events conducted during Experiment 12 are shown on the

isometric diagram in Figure 3.140.

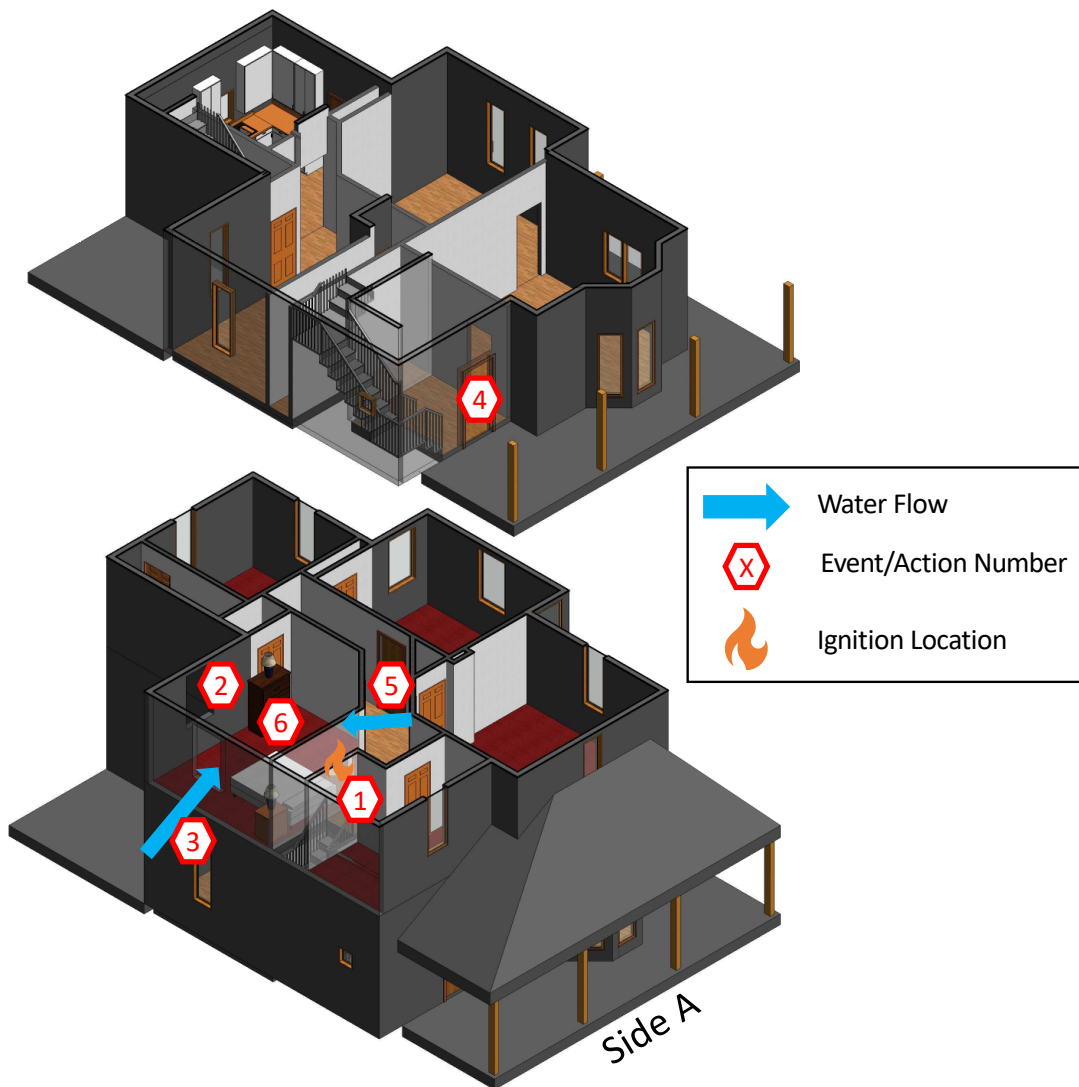

Action/Event	Time (mm:ss)	Time (s)
1 Ignition	00:00	0
2 Flashover	04:35	275
3 Exterior Water, Bedroom 3 Window	07:01	421
4 Front Door Open, Second-Floor Windows Vented	07:15	435
5 Flow from Fire Room Doorway	08:36	516
6 Suppression Crew Entered Fire Room	08:53	533

Figure 3.140: Time and sequence of actions and events for Experiment 12.

The thermocouple array in bedroom 3 first began to register a temperature increase approximately

30 s post ignition. The temperatures began to increase more rapidly as the fire spread from the chair to the mattress. Interior and exterior camera views indicated the fire began to vent from the fire room into the hallway at 187 s and was first seen venting out the window at 210 s. Shortly afterward, the fire room transitioned through flashover 275 s post ignition. After flashover, the temperatures in the fire room (bedroom 3) exceeded the listed calibration of the thermocouple wire used, introducing a greater amount of uncertainty to the temperature measurements taken after this time. The fire remained in a post-flashover state until the initial fire department action. The exterior suppression action caused temperatures in the fire room to decrease.

Approximately 470 s post ignition (48 s after exterior suppression was started), temperatures began to increase, starting with those closest to the ceiling and followed by the temperatures closer to the floor. Interior suppression from the fire room doorway permanently decreased the temperatures in the fire room.

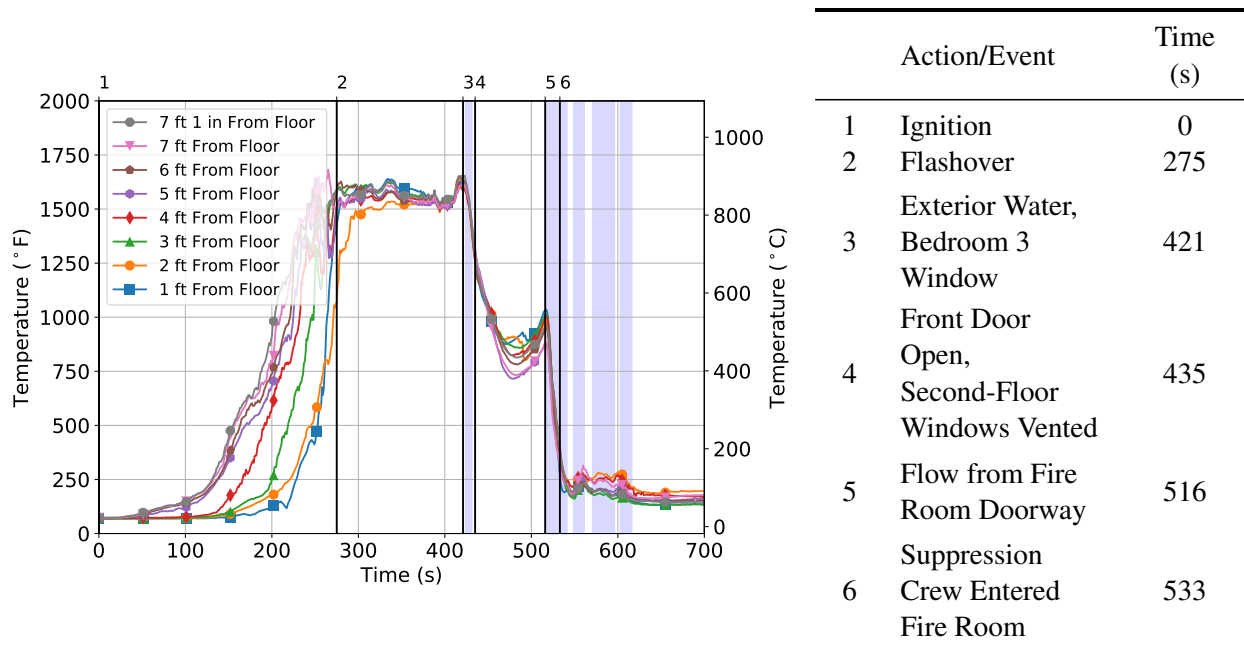
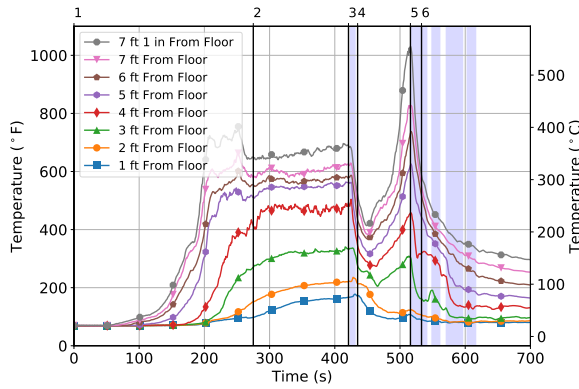

Figure 3.141: Fire room (bedroom 3) temperature data for Experiment 12. Blue vertical bars indicate time and duration of water flow.

Temperatures in both hallway locations began to increase as smoke began to spill from the fire room (bedroom 3) into the hallway. These temperatures increased more rapidly as fire vented into the hallway approximately 187 s post ignition. Both measurement locations reached a peak corresponding with flashover and maintained steady values in the time leading up to fire department intervention. The temperatures in the hallway locations outside bedroom 1 (see Figure 3.142a) were greater than those between bedrooms 2 and 3. Temperatures at this location ranged between 165 °F, 1 ft above the floor, and 685 °F, 7 ft 11 in. above the floor, at the time of intervention. Exterior suppression reduced temperatures in the hallway to 95 °F 1 ft above the floor and to 420 °F 7 ft 11 in. above the floor. The decrease in temperatures was temporary, as the 3 ft through 7 ft 11 in. temperatures increased approximately 450 s post ignition (29 s after exterior suppression began).

The temperatures higher than 3 ft continued their increase until the suppression crew reached the fire room doorway and began interior suppression, reaching peaks ranging from 300 °F at 3 ft to 1025 °F at 7 ft 11 in. The temperatures 3 ft and above permanently decreased as suppression continued. Meanwhile, the 1 ft and 2 ft temperatures continued to decrease as fresh air from the open front door flowed up the stairs, through the hallway, and into the fire room.



(a) Hallway Temperatures Outside Bedroom 1

	Action/Event	Time (s)
1	Ignition	0
2	Flashover	275
3	Exterior Water, Bedroom 3 Window	421
4	Front Door Open, Second-Floor Windows Vented	435
5	Flow from Fire Room Doorway	516
6	Suppression Crew Entered Fire Room	533

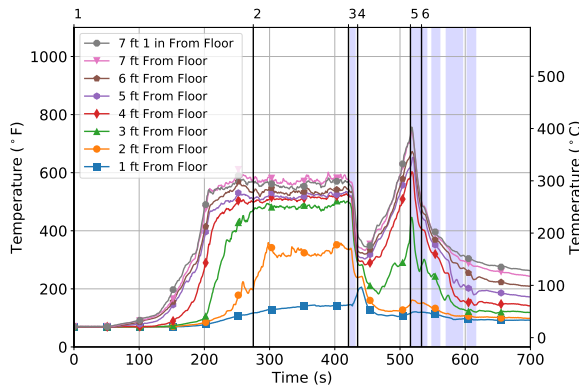

(b) Hallway Temperatures Between Bedroom 2 and 3

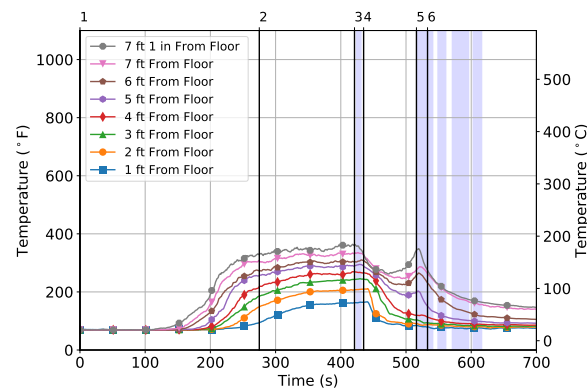

(c) Bedroom 1 Temperatures

Figure 3.142: Temperatures in open areas of second-floor of structure for Experiment 12. Blue vertical bars indicate time and duration of water flow.

The temperatures in the hallway outside bedroom 2 (see Figure 3.142b) were less than outside bedroom 1, ranging from 140 °F at 1 ft to 594 °F, at 7 ft 11 in., at the time of intervention. Exterior suppression dropped the temperatures from the 2 ft through 7 ft 11 in. temperatures, while the 1 ft temperature at this location increased slightly from 145 °F to 205 °F. Like the temperatures at the other hallway location, the temperatures 3 ft and above increased at 450 s as the fire regrew, while the 1 ft and 2 ft temperatures decreased because of the fresh air being entrained into the fire room. The hallway temperatures peaked between 445 °F at 3 ft and 755 °F at 7 ft 11 in. The peak temperatures at both hallway measurement locations corresponded to fire venting from the fire room into the hallway as the suppression crew began interior suppression shown in Figure 3.143.



Figure 3.143: Fire conditions meeting suppression crew in hallway outside bedroom 3.

Bedroom 1 temperatures followed a similar trend to temperatures in the hallway and fire room (bedroom 3), although the magnitude of the temperatures were lower because of the proximity to the fire room. Exterior suppression decreased the temperature at all elevations, but the effect was not as pronounced as in the hallway. When temperatures began to increase due to fire regrowth, only the temperatures 5 ft and above began to increase. This is likely because of both the distance from the fire room and the additional horizontal ventilation that occurred at 435 s after ignition (Event 4). All temperatures decreased toward pre-ignition conditions when interior suppression was initiated.

The heat flux, measured 1 ft and 3 ft above the floor in the hallway and 1 ft above the floor in bedroom 1, followed a similar trend to the temperatures at those locations. Heat flux at both locations in the hallway (see Figure 3.144a) increased shortly before flashover as fire was observed venting into the hallway. Heat flux increased until fire department intervention, peaking at 3 kW/m^2 and 6 kW/m^2 at 1 ft and 3 ft, respectively. Suppression reduced the 1 ft and 3 ft heat fluxes to 1 kW/m^2 and 2 kW/m^2 , respectively. Fire regrowth 450 s post ignition increased heat flux to final peaks of 2 kW/m^2 and 3 kW/m^2 , respectively. Final suppression reduced the heat flux at both elevations to negligible values. The heat flux in bedroom 1, shown in Figure 3.144b, was significantly less than the corresponding height in the hallway, reaching a peak of 2 kW/m^2 shortly before fire department intervention. Suppression decreased the heat flux below 1 kW/m^2 for the remainder of the experiment.

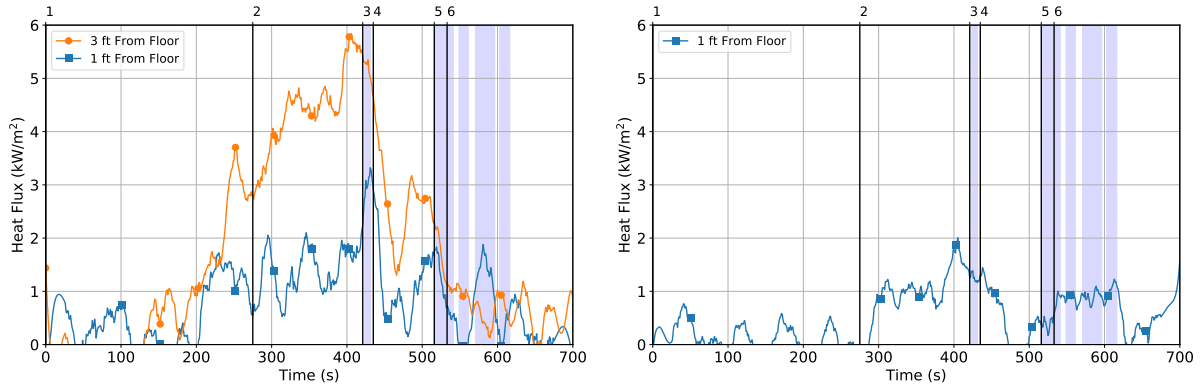

(a) Hallway Heat Flux

(b) Bedroom 1 Heat Flux

	Action/Event	Time (s)
1	Ignition	0
2	Flashover	275
3	Exterior Water, Bedroom 3 Window	421
4	Front Door Open, Second-Floor Windows Vented	435
5	Flow from Fire Room Doorway	516
6	Suppression Crew Entered Fire Room	533

Figure 3.144: Heat flux at remote locations for Experiment 12. Blue vertical bars indicate time and duration of water flow.

The increase in fire room (bedroom 3) pressure mirrored the increase in temperatures described previously (see Figure 3.145a). The 7 ft pressure in the fire room increased approximately 30 s post ignition as a smoke layer developed in the fire room. As the fire continued to grow, the 4 ft pressure increased and the 1 ft pressure decreased, indicating bi-directional flows were created in the fire room windows and doorway. Fresh air was entrained through the lower portion and hot gases were exhausted through the top portion of these ventilation openings. The 7 ft, 4 ft, and 1 ft pressures experienced errors at 245 s, 328 s, and 319 s, respectively. Therefore, this data is not shown.

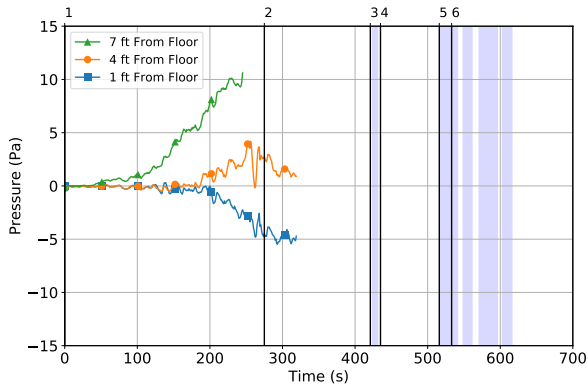

(a) Bedroom 3 Pressure

Action/Event	Time (s)
1 Ignition	0
2 Flashover	275
3 Exterior Water, Bedroom 3 Window	421
4 Front Door Open, Second-Floor Windows Vented	435
5 Flow from Fire Room Doorway	516
6 Suppression Crew Entered Fire Room	533

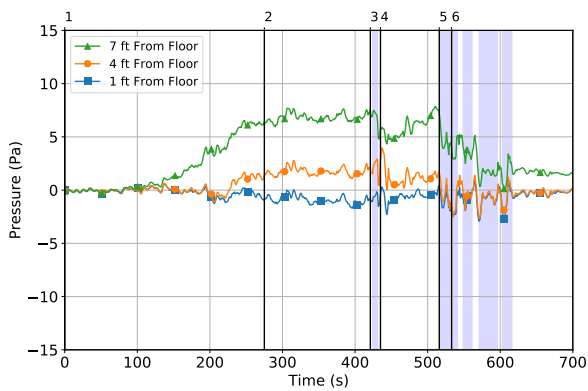

(b) Hallway Pressure

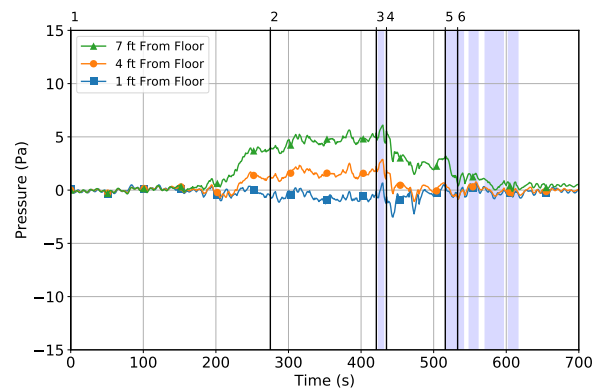

(c) Bedroom 1 Pressure

Figure 3.145: Second-floor pressures during Experiment 12. Blue vertical bars indicate time and duration of water flow.

Hallway pressure followed a similar initial trend to the fire room (bedroom 3), with the 7 ft pressure being the first to increase as smoke traveled into this area of the second-floor. As the fire grew, the 4 ft pressure increased above 0 Pa, while the 1 ft pressure decreased below 0 Pa. This profile was maintained until fire department intervention. Exterior suppression did not affect the 1 ft or 4 ft pressures substantially, but decreased the 7 ft pressure. The 7 ft pressure increased approximately 450 s post ignition, mirroring the regrowth of the temperatures. The opening of the front door and horizontal ventilation of the second-floor windows caused a drop in pressure at the 4 ft elevation, which did not decrease in the period leading up to interior suppression. After interior suppression, all pressures converged to 0 Pa.

Bedroom 1 pressures also followed a similar trend, although the magnitude of the pressures were lower. Fresh air entrained through the windows caused both the 1 ft and 4 ft pressures to decrease below 0 Pa.

Gas concentrations were measured at the same locations as heat flux—1 ft and 3 ft above the floor in the hallway, and 1 ft above the floor in bedroom 1—in an effort to examine the effects of

ventilation on potential trapped occupants. As the fire grew and smoke filled the hallway, the O₂ concentrations decreased, while CO₂ and CO concentrations increased. The 3 ft gas concentrations increased approximately 225 s post ignition and continued to increase through the post-flashover period, reaching steady values of 4%, 16%, and 3% for O₂, CO₂, and CO, respectively. The exterior suppression action and ventilation sequence caused the 3 ft O₂ to increase and the 3 ft CO₂ and CO to decrease. The improvement in conditions was halted approximately 480 s post ignition as the fire regrew. Interior suppression from the fire room doorway caused the 3 ft gas concentrations to rapidly trend to ambient.

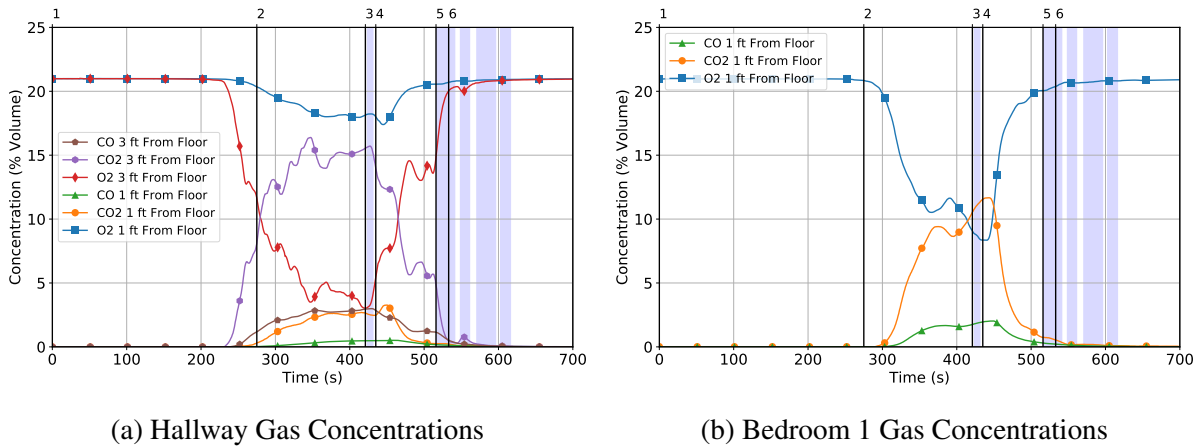

	Action/Event	Time (s)
1	Ignition	0
2	Flashover	275
3	Exterior Water, Bedroom 3 Window	421
4	Front Door Open, Second-Floor Windows Vented	435
5	Flow from Fire Room Doorway	516
6	Suppression Crew Entered Fire Room	533

Figure 3.146: Gas concentrations at remote locations for Experiment 12. Blue vertical bars indicate time and duration of water flow.

The 1 ft O₂ concentrations in the hallway were greater and the CO₂ and CO concentrations were less than the 3 ft values at the same location. The gas concentrations at this elevation increased approximately 260 s post ignition, at approximately the same time the camera in the hallway lost visibility. The gas concentrations at the time of intervention were 18%, 3%, and 1% for O₂, CO₂, and CO respectively. One of the reasons for the greater O₂ and lower CO and CO₂ concentrations is that fresh air from the first-floor was still flowing past this sensor location into the fire room. Immediately after the exterior suppression action, there was a brief change in gas concentrations, with the O₂ decreasing from 18.2% to 17.5%, the CO₂ increasing from 2.5% to 3.3%, and the CO increasing from 0.5 to 0.6%. The entrainment of fresh air through the front door of the structure quickly reduced the gas concentrations to approximately pre-ignition conditions by the time the suppression crew had started interior water flow from the fire room doorway.

Since the 1 ft gas concentration measurement port in bedroom 1 was not located in the fresh air portion of the flow path, gas concentrations reached notably lower peak O₂ volume percent and greater CO₂ and CO volume percent than the corresponding elevation in the hallway. The gas concentrations first started to increase approximately 290 s post ignition, at around the same time the camera in this room lost visibility. At the time of fire department intervention, the O₂ was still decreasing and CO₂ and CO were still increasing, and had values of 9%, 11%, and 3%, respectively. The gas concentrations continued to decrease and increase through exterior suppression. After the bedroom 1 windows were horizontally ventilated and the front door was opened, the gas concentrations reached a peak and began to trend to ambient with 10 s.

The increase and decrease in temperatures and toxic gas concentrations highlights the changes in gas flow over the course of the experiment, shown in Figure 3.147. As the fire became ventilation-limited, bi-directional flows were established through the fire room windows and doorway (see Figure 3.147a). Fresh air from the exterior of the structure was entrained into the windows, while hot gases were exhausted to the exterior. Similarly, fresh air was entrained from remote areas of the first and second-floors through the fire room doorway and were replaced with smoke. When the front door was opened, a flow path was created from the front door to the fire room (see Figure 3.147b), along which fresh air was entrained, keeping temperatures and gas concentrations low. Additionally, flow paths were created through the bedroom 1 windows, which allowed smoke trapped in this room to exhaust and be replaced with fresh air (see Figure 3.147c). Eventually, temperatures increased again as the effect of suppression subsided and the additional air provided by the ventilation action allowed the fire to regrow before final suppression resulted in a permanent decrease in temperatures.

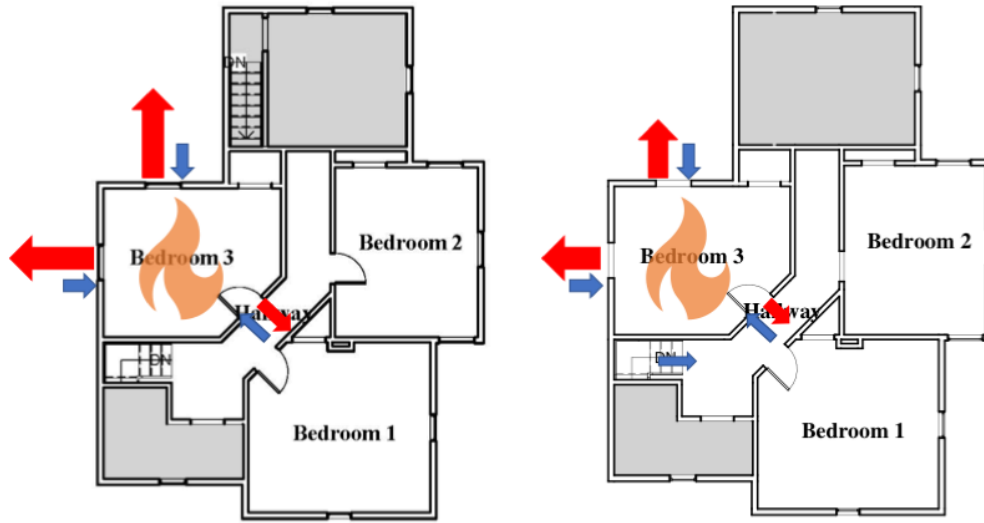

(a) Prior to Front Door Opened

(b) After Front Door Opened

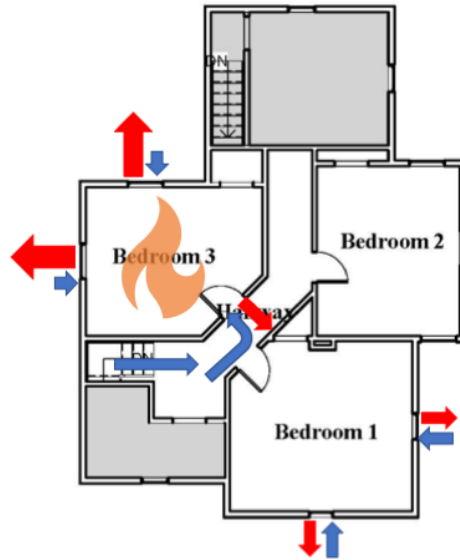

(c) After Horizontal Ventilation

Figure 3.147: Changes in flow during Experiment 12. Red arrows indicate flow out of the compartment, blue arrows indicate entrainment into the compartment, and the sizes of the arrows indicate the relative magnitude of the flow through each opening.

Bedroom Fires Method 4

3.13 Experiment 13 — Exterior Fire Control with Failed Ceiling

Experiment 13 was designed to evaluate exterior suppression with a failed fire room ceiling followed by a transition to interior suppression; this experiment used Coordination Method 4. At 1492 Dayton Xenia Road in Xenia, Ohio, a two-story, 2,100 sq ft, wood frame structure was instrumented to conduct this second-floor bedroom fire experiment. The four exterior sides of the structure appear in Figure 3.148. The structure was stick-built with rough cut lumber framing and wood-slat siding. The foundation was a mix of concrete block and stone. The hip-style roof was constructed using 1 in.-by-6 in. sheathing covered with asphalt shingles. Detailed dimensioned drawings for the first and second story appear in Appendix Figures B.14 and B.15, respectively.



Figure 3.148: Exterior photographs of the structure for Experiment 13.

The first-floor of the structure had a living room, dining room, and kitchen. The second-floor had

three bedrooms along a shared hallway. A stairwell located in the A/D corner of the structure connected the two floors. These areas defined the experimental volume of the structure. Various closets, bathrooms, and a flex space were separated from the internal volume of the structure and used to protect instrumentation. The structure was instrumented for temperature, pressure, heat flux, IR, and standard video to capture the fire dynamics during experimentation. Instrumentation was also installed to characterize the potential for skin burns and occupant toxic exposure during the experiment. Figure 3.149 shows the layout of the first and second-floors with instrumentation locations.

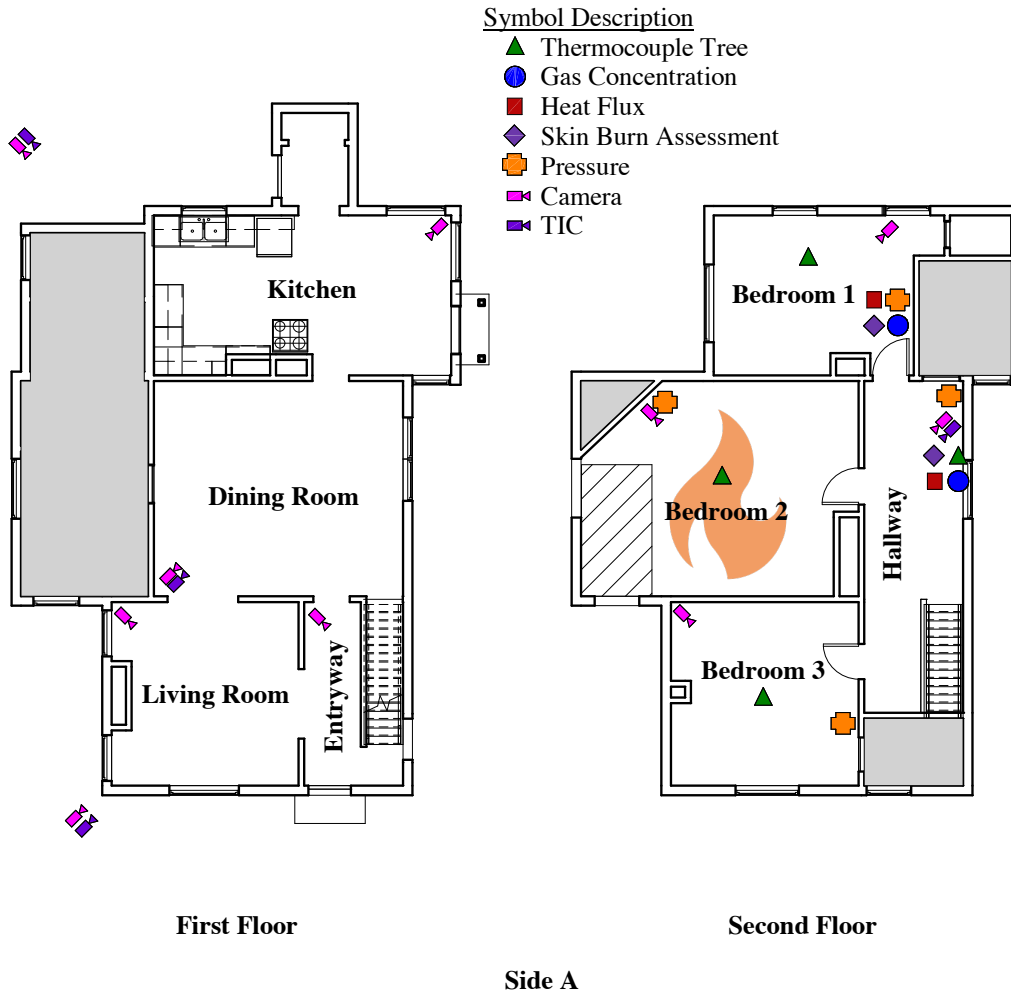

Figure 3.149: Instrumentation and floor plan for Experiment 13. The gray areas were isolated from the remainder of the structure and utilized as space for instrumentation. The diagonal hatched box indicates the size and location of the failed ceiling.

The fire room (bedroom 2) was furnished with the standard bedroom fuel package described in Section 2.4.1. The fuel package was increased to also contain a sofa, described in Section 2.4.1. Photographs of the fire room prior to ignition are presented in Figure 3.150. A dimensioned layout

of the fire room is included in Figure 3.151. The windows located on the side A and side B of the structure were left open (numbered 21 and 22 in Figure 3.151) to ensure repeatable fire growth.



(a) A/B Corner



(b) B/C Corner



(c) Side C Wall



(d) Side D Wall

Figure 3.150: Interior photographs of fire room for Experiment 13.

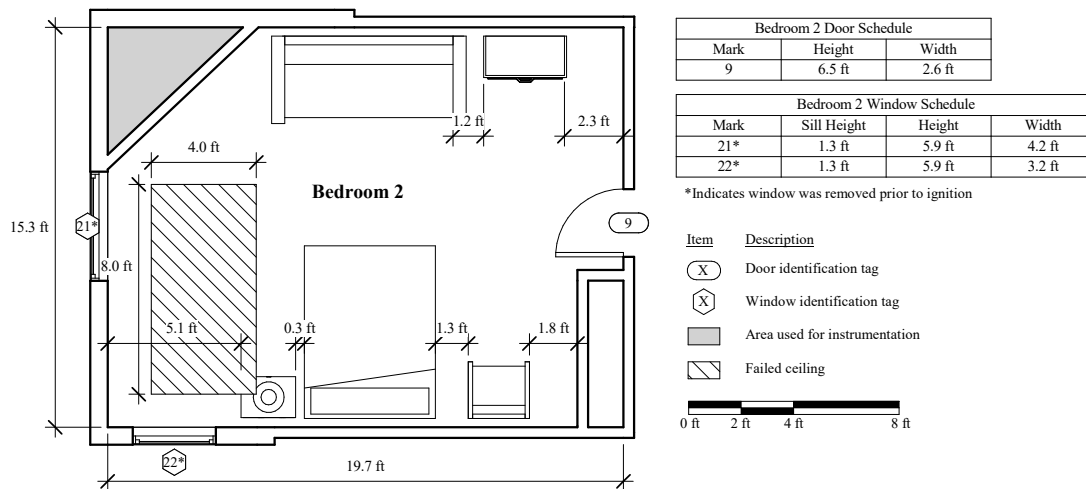

Figure 3.151: Fire room layout for Experiment 13. The diagonal hatched box indicates the size and location of the failed ceiling.

Experiment 13 examined the effectiveness of two different exterior water flow techniques during a failed ceiling scenario followed by interior water flow to extinguish the fire. The first exterior water flow technique utilized a straight stream directed into the fire room's failed ceiling, resulting in a steep angle between the stream and the ceiling. The second exterior water flow technique utilized a straight stream directed onto the side B window lintel (window header), at steep angle between the stream and the lintel. A 8 ft by 4 ft ceiling hole was cut and removed in the fire room (bedroom 2). A 9 ft by 5 ft drywall-plywood cover was placed over the hole and sealed within insulation to prevent air leakage. The cover was constructed to be removed remotely by the ventilation crew located outside the structure. The cover was removed after ignition but before any fire department intervention, replicating a failed ceiling. The cover before ignition and hole after suppression are presented in Figure 3.152.



Figure 3.152: Interior photographs of the failed ceiling prior to ignition (see Figure 3.152a) and after suppression (see Figure 3.152b) for Experiment 13.

The upholstered chair located next to the mattress was ignited ($t = 0$ s). Flames were first visible from the fire room camera 72 s post ignition (1:12). As the fire grew in size, the room filled with smoke, exhausting into the hallway 126 s (2:06) post ignition. Approximately 150 s (2:30) post ignition, smoke first appeared from the side A window (labeled 22 in Figure 3.152). Flames first became intermittently visible from this window and in the hallway approximately 250 s (4:10) post ignition. As the fire spread to the floor, 272 s (4:32) post ignition, flames became continuous from the side A window and intermittently visible from the side B window (labeled 21 in Figure 3.152). Approximately 282 s (4:42) post ignition, flames spread to the sofa and became continuous from the side B window. Shortly thereafter, flashover of the fire room occurred, 287 s (4:47) post ignition. The fire reached a steady post-flashover state before the simulated ceiling failure occurred 360 s (6:00) post ignition.

Fire department interventions began 420 s (7:00) post ignition with the first exterior water flow application through the side B window. For 17 s, the stream was directed into the failed ceiling and a steep angle was ensured. An evaluation period to determine the tactic's effectiveness took place before the second exterior water flow technique occurred. At 720 s (12:00) post ignition, the second exterior water flow through the side B window occurred. For 15 s the stream was directed off the window lintel and dispersed water throughout the fire room.

The front door was opened 751 s (12:31) post ignition just before the suppression crew transitioned to a secondary hoseline. The suppression crew advanced inside the structure and halfway up the stairwell. Once in the stairwell, the suppression crew initiated an interior water flow 825 s (13:45) post ignition for 7 s in duration. The suppression crew advanced to the top of the stairs and onto the landing before a second interior water flow application occurred 847 s (14:07) post ignition with a duration of 19 s. The crew advanced to the fire room doorway before flowing water for a third time 873 s (14:33) post ignition with a duration of 26 s. Once the fire room was sufficiently cool, the suppression crew entered for final extinguishment 915 s (15:15) post ignition. Final extinguishment occurred for a duration of 15 s. Following final interior suppression, the secondary crew used the primary hoseline still located on the exterior of the structure to extinguish flames on side A and side B of the structure at 959 s (15:59) post ignition, for duration of 23 s. The total tactic time from initial exterior suppression to interior extinguishment was 405 s (6:45). The total water flowed for initial suppression was 192 gal, 111 gal from the primary hoseline and 81 gal from the secondary hoseline. The total water flowed for initial suppression did not include water flowed during mop-up operations.

Two 1.75 in. hoselines both with a combination nozzle set to straight stream were used during this experiment. The primary hoseline was placed on side B of the structure and used to apply water to the fire from the exterior and extinguish exterior surface flames. The secondary hoseline was placed on side A of the structure and advanced inside to apply water from the interior. Figure 3.153 indicates the time and sequence of fire department interventions along with an isometric drawing of the structure.

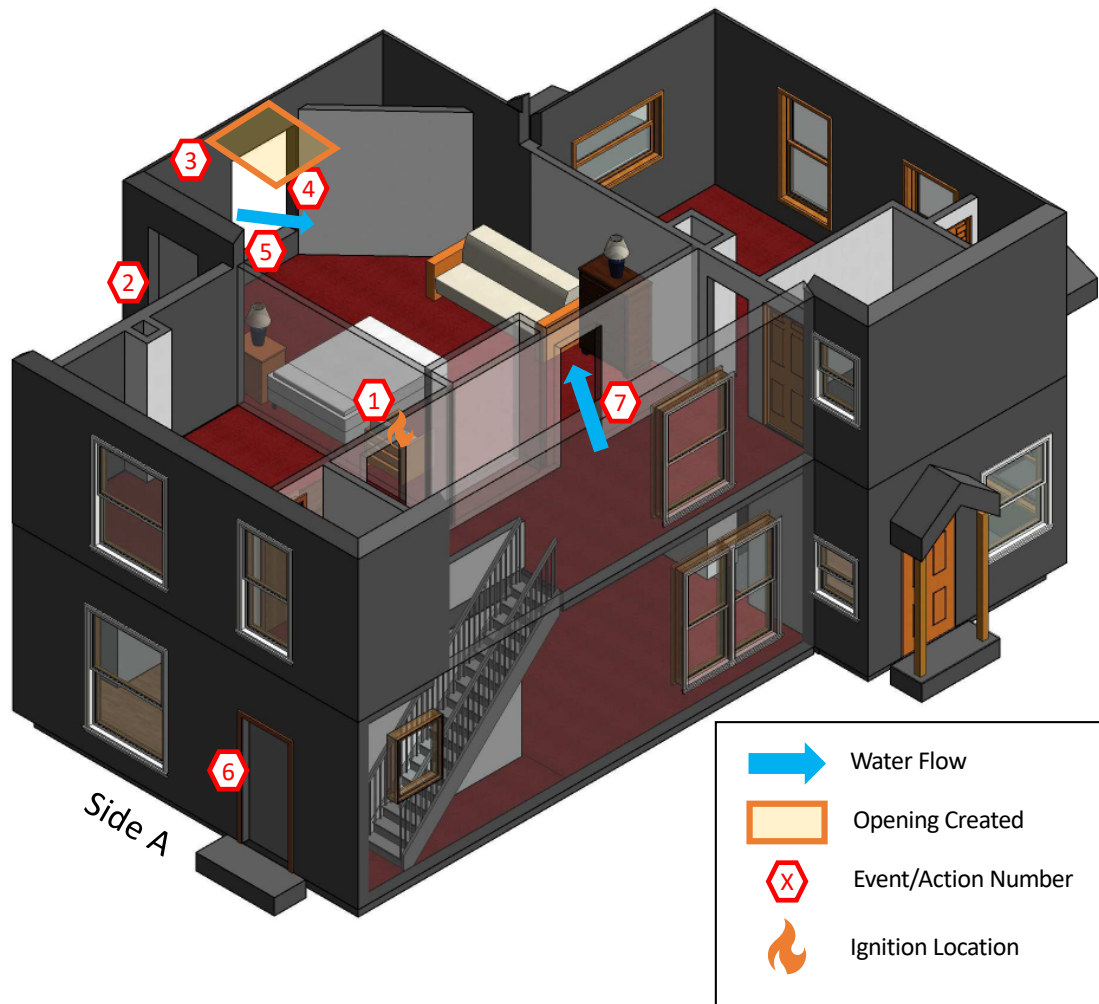

Action/Event	Time (mm:ss)	Time (s)
1 Ignition	00:00	0
2 Flashover	04:47	287
3 Ceiling Failure	06:00	360
4 Exterior Flow - Ceiling	07:00	420
5 Exterior Flow - Lintel	12:00	720
6 Front Door Open	12:31	751
7 Interior Flow	13:45	825

Figure 3.153: Time and sequence of actions and events for Experiment 13.

The fire room (bedroom 2) temperatures were monitored by a thermocouple array, presented in Figure 3.154. Temperatures 5 ft and above began to increase approximately 100 s post ignition, corresponding to smoke accumulation at the ceiling of the fire room. Temperature near the floor of the fire room increased just prior to flashover at 287 s post ignition. Temperatures during flashover

exceed the listed calibration for the thermocouple wire used, causing an increased uncertainty associated with the measurements for the duration of the experiment. Post-flashover conditions produced steady temperatures within the fire room. The simulated ceiling failure caused an increase in fire room temperatures as gases within the room began to fill the attic with smoke which entrained more air in the room. Temperatures 6 ft and above increased just prior to the first exterior water flow application. Temperatures decreased during and after the first exterior water flow, but increased again 470 s post ignition. The fire then regrew before the second exterior water flow application. Temperatures returned to near pre-ignition conditions after the second water flow application.

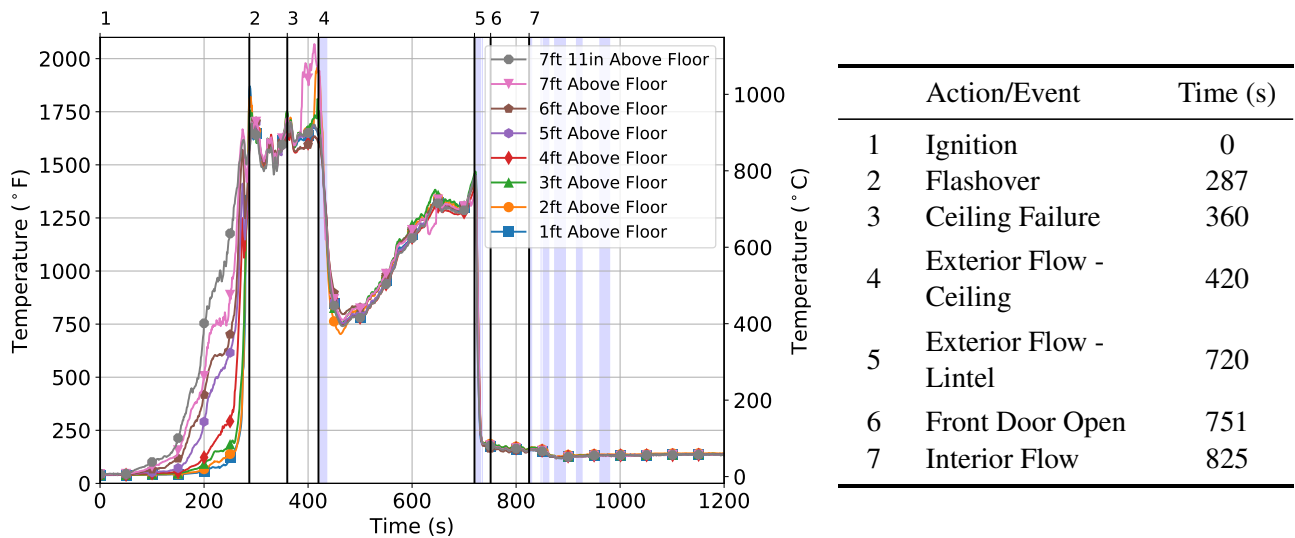
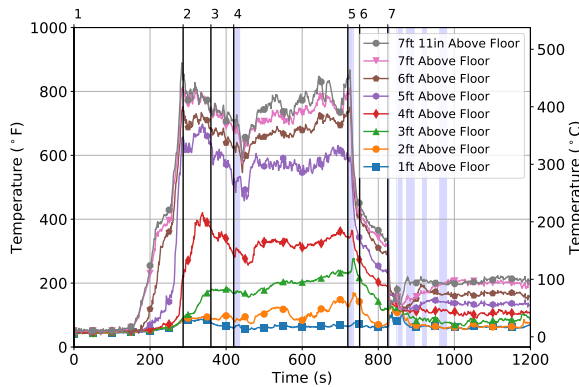

Figure 3.154: Fire room (bedroom 2) temperatures for Experiment 13. Blue vertical bars indicate time and duration of water flow.

Temperature data for locations on the second-floor are presented in Figure 3.155. Hallway temperatures were greater than bedroom temperatures. Hallway temperatures 5 ft and above began to increase approximately 180 s post ignition. This corresponded to the smoke layer exhausting into the hallway. All temperatures increased just prior to flashover in the fire room at 287 s. Temperatures 4 ft and below continued to increase after flashover, while temperatures above 4 ft became steady. Temperatures remained steady until the second exterior water application. Bedroom 1 and bedroom 3 temperatures behaved similarly. Temperatures increased in both locations approximately 200 s post ignition. Following flashover in the fire room at 287 s post ignition, temperatures within the structure became steady. A decrease in remote temperatures did not occur until after the second exterior water flow occurred at 720 s post ignition. Temperatures returned to pre-ignition conditions after interior water flow at 825 s post ignition.



(a) Hallway Temperatures

Action/Event	Time (s)
1 Ignition	0
2 Flashover	287
3 Ceiling Failure	360
4 Exterior Flow - Ceiling	420
5 Exterior Flow - Lintel	720
6 Front Door Open	751
7 Interior Flow	825

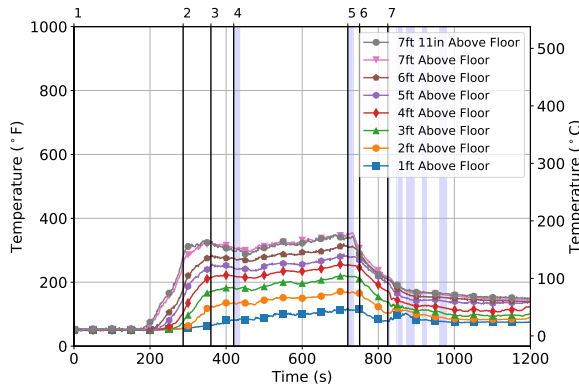

(b) Bedroom 1 Temperatures

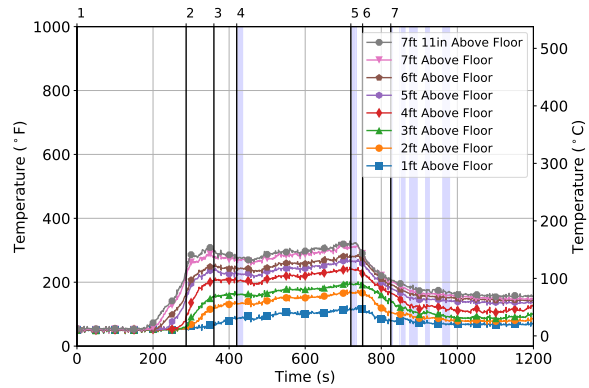

(c) Bedroom 3 Temperatures

Figure 3.155: Second-floor temperatures (hallway, bedroom 1 and bedroom 3) for Experiment 13. Blue vertical bars indicate time and duration of water flow.

The fire caused a pressure gradient within the fire room (bedroom 2) as shown in Figure 3.156. The pressure began to change around 100 s post ignition as the smoke layer at the ceiling began to form. Pressure at the 7 ft elevation increased with the production and accumulation of smoke at the ceiling and expansion of gases due to elevated temperatures. Pressure at the 1 ft elevation began to decrease around 200 s as the fire entrained air. Prior to flashover at 287 s, the pressure at the 4 ft elevation increased. Post-flashover conditions created stable pressures at all three elevations that were unaffected by the failed ceiling. During the fire regrowth following the first exterior water application, the top two pressure transducers failed. After the second exterior water application, the 1 ft elevation pressure began to return to pre-ignition levels. Following interior water application, the pressure sensor was affected by the the water flow as illustrated by the large spikes in the data.

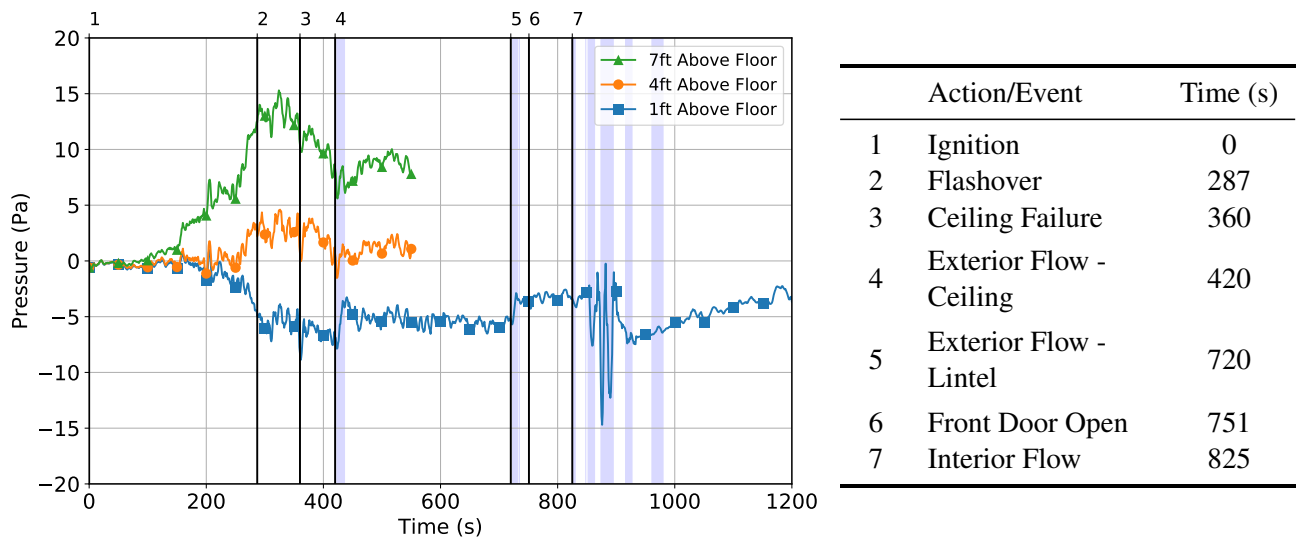
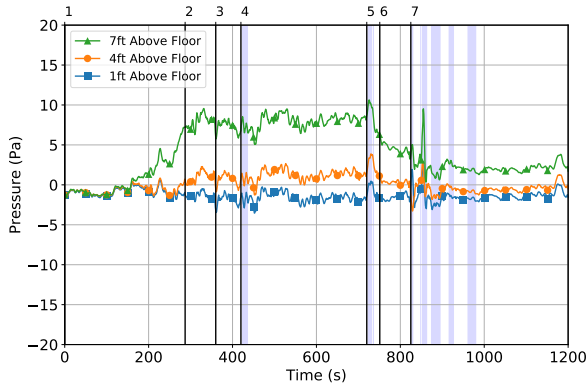
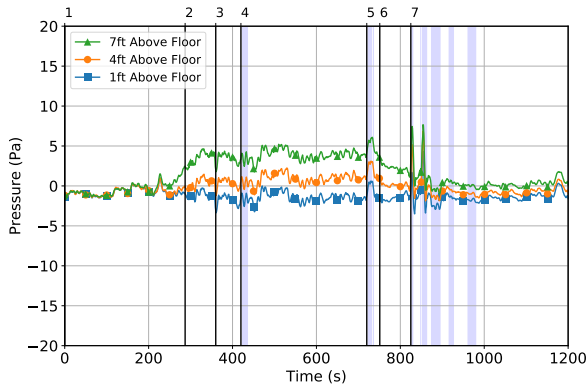

Figure 3.156: Pressures in the fire room (bedroom 2) for Experiment 13. Blue vertical bars indicate time and duration of water flow.

Pressures remote from the fire room (hallway, bedroom 1, and bedroom 3) indicate a bi-directional flow of gases throughout the structure. Pressure at all three remote locations began to change approximately 200 s post ignition as the smoke traveled throughout the structure. The 7 ft elevation was highest in the hallway as it was closest to the fire room. The positive pressure at the 7 ft elevation indicates gas expansion at the ceiling. Pressure at the 4 ft elevation remained at atmospheric until flashover, when it increased with the smoke layer descent. Pressure at the 1 ft elevation was lowest in the hallway because it was closest to the fire room. Pressure at the 1 ft elevation became negative, indicating air entrainment throughout the structure toward the fire room (bedroom 2). After flashover, pressures within the structure became stable. After the second exterior water application, pressures at all locations and elevations began to return to atmospheric pressure.



(a) Hallway Pressure



(b) Bedroom 1 Pressure

	Action/Event	Time (s)
1	Ignition	0
2	Flashover	287
3	Ceiling Failure	360
4	Exterior Flow - Ceiling	420
5	Exterior Flow - Lintel	720
6	Front Door Open	751
7	Interior Flow	825

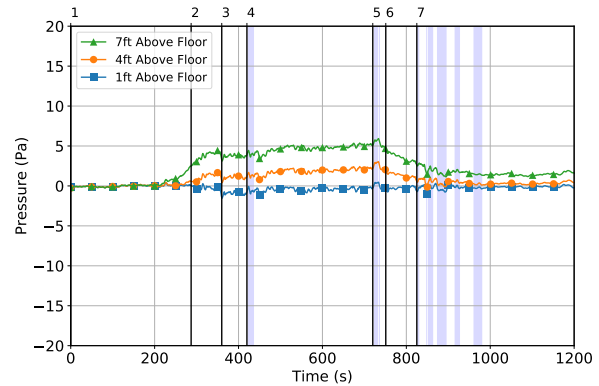

(c) Bedroom 2 Pressure

Figure 3.157: Pressure remote from the fire room for Experiment 13. Blue vertical bars indicate time and duration of water flow.

The pressure differential between remote locations within the structure were an indication of flows. Figure 3.158 indicates the flow path within the structure before and after fire department ventilation of the front door. Prior to fire department intervention, pressure at the 7 ft elevation in the fire room (bedroom 2) was greater than the pressure at the 7 ft elevation in the hallway or remote bedrooms. Similarly, the pressure at the 1 ft elevation in the fire room was less than the pressure at the 1 ft elevation in any remote location. These pressure gradients reflect entrainment into the fire room through the bottom of the fire room doorway and hot gases out through the top of the fire room doorway. The flow path prior to fire department intervention is illustrated in Figure 3.158a. Initially, the only ventilation openings were the fire room windows, which entrained fresh air and exhausted hot gases. After the ceiling failed, a new exhaust vent was established (see Figure 3.158b). This new exhaust vent resulted in increased entrainment from remote areas of the structure. Finally the front door was opened (see Figure 3.158c which provided another inlet vent for air flow into the structure.

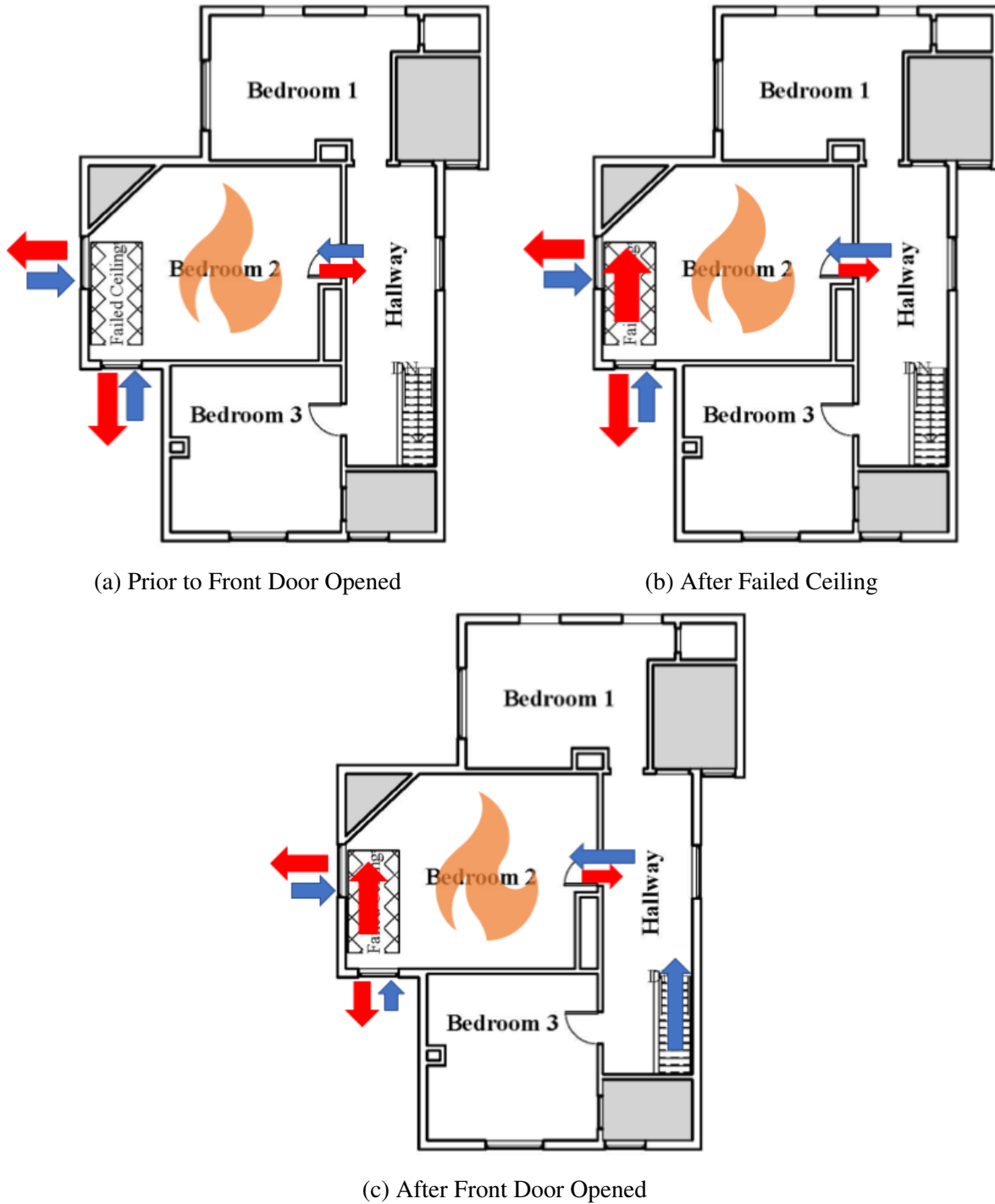
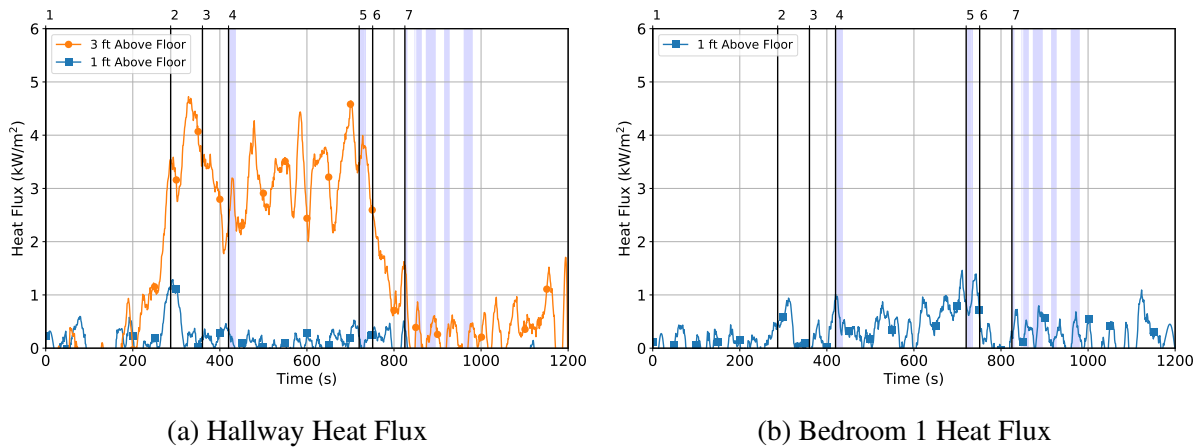

Figure 3.158: Changes in flow path for Experiment 13. The red arrows indicate flow out of the compartment, the blue arrows indicate entrainment into the compartment, and the sizes of the arrows indicate the relative magnitude of the flow through each opening.

Two measurement locations were established to monitor conditions throughout the structure, hallway, and bedroom 1. Heat flux was monitored at both locations; the data collected is presented

in Figure 3.159. The hallway heat flux was measured at 1 ft and 3 ft elevations above the floor. Heat flux first began to increase approximately 200 s post ignition. Heat flux at both elevations increased just prior to flashover at 287 s. The 3 ft elevation was greater than the 1 ft elevation because this elevation was closer to the smoke layer. After flashover, the 1 ft elevation decreased back to atmospheric conditions and remained constant throughout the remainder of the experiment. The 3 ft elevation increased until the simulated ceiling failure. After which, the 3 ft heat flux decreased and remained steady until the second exterior water flow application. The 3 ft elevation began returning to atmospheric conditions before interior water flow.

The bedroom 1 heat flux was measured at the 1 ft elevation above the floor. Heat flux remained below 1 kW/m² for the majority of the experiment as the measurement location was more remote from the fire room than the hallway. There was a peak around 1.5 kW/m² prior the second exterior water flow application and dropped following the front door being opened.



	Action/Event	Time (s)
1	Ignition	0
2	Flashover	287
3	Ceiling Failure	360
4	Exterior Flow - Ceiling	420
5	Exterior Flow - Lintel	720
6	Front Door Open	751
7	Interior Flow	825

Figure 3.159: Heat flux versus time in the hallway and bedroom 1 for Experiment 13. Blue vertical bars indicate time and duration of water flow.

The aforementioned locations also monitored gas concentrations for CO, CO₂, and O₂ at the elevations as heat flux. An increase in CO₂ and CO corresponded to a decrease in O₂. The gas concentrations for the location in the hallway began to change just after fire room flashover 287 s post ignition. CO₂ and CO gas concentrations were greater at the 3 ft elevation than at the 1 ft elevation throughout the experiment. After the first exterior water flow application, O₂ gradually decreased, while CO and CO₂ gradually increased. After the second water flow application, con-

ditions improved briefly. The front door was opened at 751 s, corresponding to decreasing CO₂ and CO and increasing O₂ concentrations in the structure. At 800 s, conditions began returning to pre-ignition concentrations.

Bedroom 1 gas concentrations did not begin to change until the ceiling failure in the fire room. The ceiling failure led to increased mixing of gases which brought smoke to the 1 ft elevation. Gas concentrations did not improve at either measurement location following the first exterior water application though conditions did improve after the second exterior water application and the front door was opened. After the first interior water flow at 825 s post ignition mixing led to gas concentrations to worsen, but conditions began returning to pre-ignition conditions after the second interior water flow at 842 s after interior suppression.

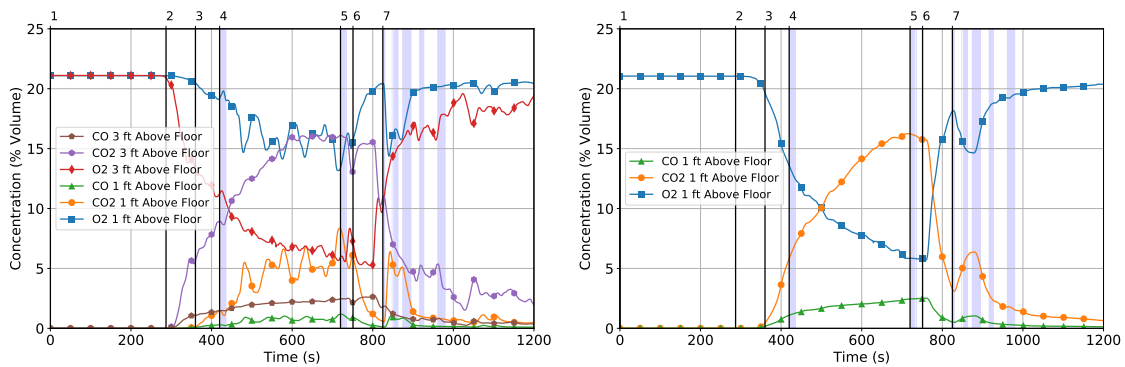

(a) Hallway Gas Concentrations

(b) Bedroom 1 Gas Concentrations

Action/Event	Time (s)
1 Ignition	0
2 Flashover	287
3 Ceiling Failure	360
4 Exterior Flow - Ceiling	420
5 Exterior Flow - Lintel	720
6 Front Door Open	751
7 Interior Flow	825

Figure 3.160: Gas concentrations for remote locations in Experiment 13. Blue vertical bars indicate time and duration of water flow.

3.14 Experiment 14 — Exterior Fire Control with Failed Ceiling

Experiment 14 was conducted to evaluate exterior suppression with a failed fire room ceiling followed by a transition to interior suppression; this experiment used Coordination Method 4. At 1030 Hilltop Road in Xenia, Ohio, a two-story, 2,200 sq ft wood frame structure was instrumented to conduct this second-floor bedroom fire experiment. The four exterior sides of the structure appear in Figure 3.161. The structure was stick-built with rough cut lumber framing with wood-slat siding. The foundation was a combination of block and stone. The original house had a hip-style tin roof supported by wood members and the rear addition had a peaked roof constructed using 1 in.-by-6 in. sheathing covered with asphalt shingles. Detailed dimensioned drawings for the first and second story appear in Appendix Figures B.12 and B.13, respectively.



(a) Side A



(b) Side B



(c) Side C



(d) Side D

Figure 3.161: Exterior photographs of the structure for Experiment 14.

The first-floor had an entryway, flex space, living room, dining room, and kitchen. The second-floor had three bedrooms and a flex space connected by a common hallway. The stairwell located on side A connected the two floors. These areas defined the experimental volume of the structure.

Various rooms located on the first and second-floors of the structure were isolated and utilized as instrumentation space. The structure was instrumented for temperature, pressure, heat flux, IR, and standard video to capture the fire dynamics during experimentation. Instrumentation was also installed to characterize the potential for skin burns and occupant toxic exposure during the experiment. Figure 3.162 shows the layout of the second-floor with the instrumentation locations.



Figure 3.162: Instrumentation and floor plan for Experiment 14. The gray areas were isolated from the remainder of the structure and utilized as space for instrumentation. The diagonal hatched box indicates the size and location of the failed ceiling.

The fire room (bedroom 2) was furnished with the standard bedroom fuel package described in Section 2.4.1. The fuel package was increased to also contain a sofa, described in Section 2.4.1. This fuel package included a mattress with associated frame, headboard, and furnishings, a nightstand, a dresser, an upholstered chair, an upholstered sofa, and two lamps. Photographs of the fire room prior to ignition are presented in Figure 3.163. A dimensioned layout of the fire room is included in Figure 3.164. To replicate a similar total structure volume found in other experiments, the doors to bedroom 1 and bedroom 3 remained closed throughout the experiment. To allow for

repeatable fire growth, both side A windows (labeled 15 and 16 in Figure 3.103) were removed prior to ignition.



(a) A/D Corner



(b) Side A



(c) B/C Corner



(d) C/D Corner

Figure 3.163: Interior photographs of fire room for Experiment 14.

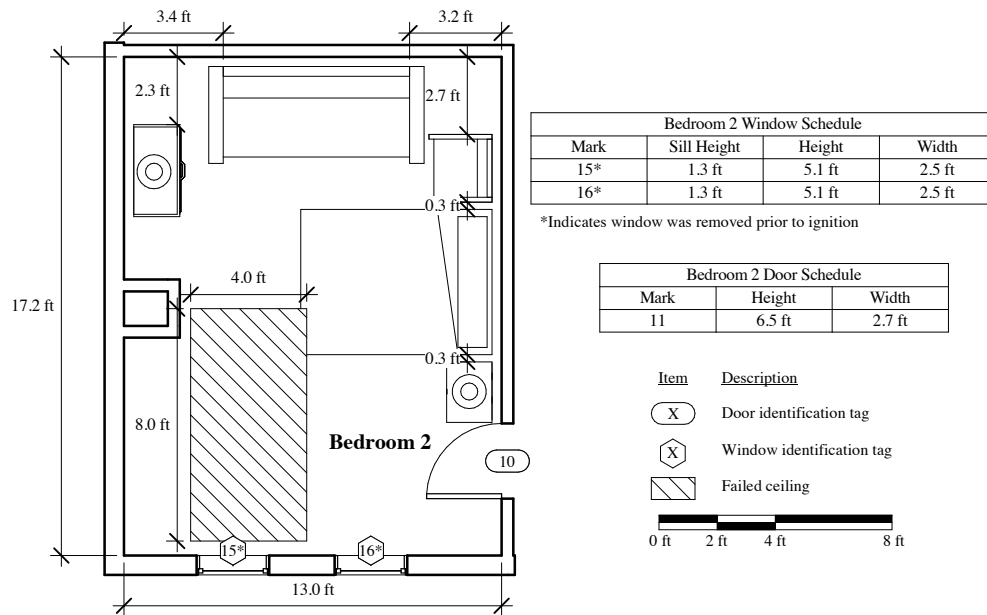

Figure 3.164: Fire room layout for Experiment 14. The diagonal hatched box indicates the size and location of the failed ceiling.

A 8 ft by 4 ft ceiling hole was cut and removed prior to ignition. A 9 ft by 5 ft drywall-plywood cover was placed over the hole and sealed within insulation to prevent air leakage. The cover was constructed to be removed from the exterior of the structure, replicating a failed ceiling. Figure 3.165 indicates the ceiling cover prior to ignition.



(a) A/D Corner

(b) A/B Corner

Figure 3.165: Interior photographs of the failed ceiling prior to ignition for Experiment 14.

The fire was ignited on the upholstered chair located in the C/D corner of the fire room ($t = 0$ s). Flames were first visible from the chair 64 s post ignition (1:04). As the fire grew, the room

filled with smoke, producing a distinctive smoke layer at the ceiling approximately 95 s (1:35) post ignition. Smoke began to exhaust from the side A windows at 108 s post ignition (1:48). Flames were visible out of the side A window closest to side D approximately 236 s (3:56) post ignition. Flames became continuous from this window at 243 s (4:03) post ignition. Flames became continuous from the side A window closest to side B roughly 5 s later, 248 s (4:08) post ignition. At 261 s (4:21) post ignition, the fire reached flashover conditions. After which, the fire transitioned into a post-flashover state. The simulated ceiling failure was conducted 361 s (6:01) post ignition.

The first fire department intervention occurred 421 s (7:01) post ignition as the first exterior water flow was applied through the side A window (labeled 15 in Figure 3.164) into the fire room. The suppression crew applied an exterior straight stream for 15 s into the failed ceiling, at a steep angle. After an evaluation period, a second exterior water application occurred 542 s (9:02) post ignition. The suppression crew applied the exterior straight stream for 18 s onto the side A window lintel (window header) at steep angle. During the second evaluation period, the front door to the structure was opened at 582 s (9:42). The suppression crew then entered the structure 629 s (10:29) post ignition and made their way to the fire room. After making entry to the fire room, the crew initiated interior water flow at 636 s (10:36) for 32 s. Additional interior water applications occurred at 674 s (11:14), 705 s (11:45), 729 s (12:09), and 759 s (12:39) for of 18 s, 12 s, 6 s, and 9 s, respectively. The total tactic time from initial exterior suppression to extinguishment was 215 s (3:35). The total water flowed for initial suppression was 242 gal, 237 gal from the primary line and 5 gal from the secondary line. Total water flowed for initial suppression did not include water flowed during mop-up operations.

A single 1.75 in. hoseline with a combination nozzle set to straight stream was used to flow water from both the exterior and interior of the structure. The line was initially placed on side A for exterior suppression and moved inside the structure for interior suppression. Figure 3.166 shows the sequence of events with an isometric image of the structure.

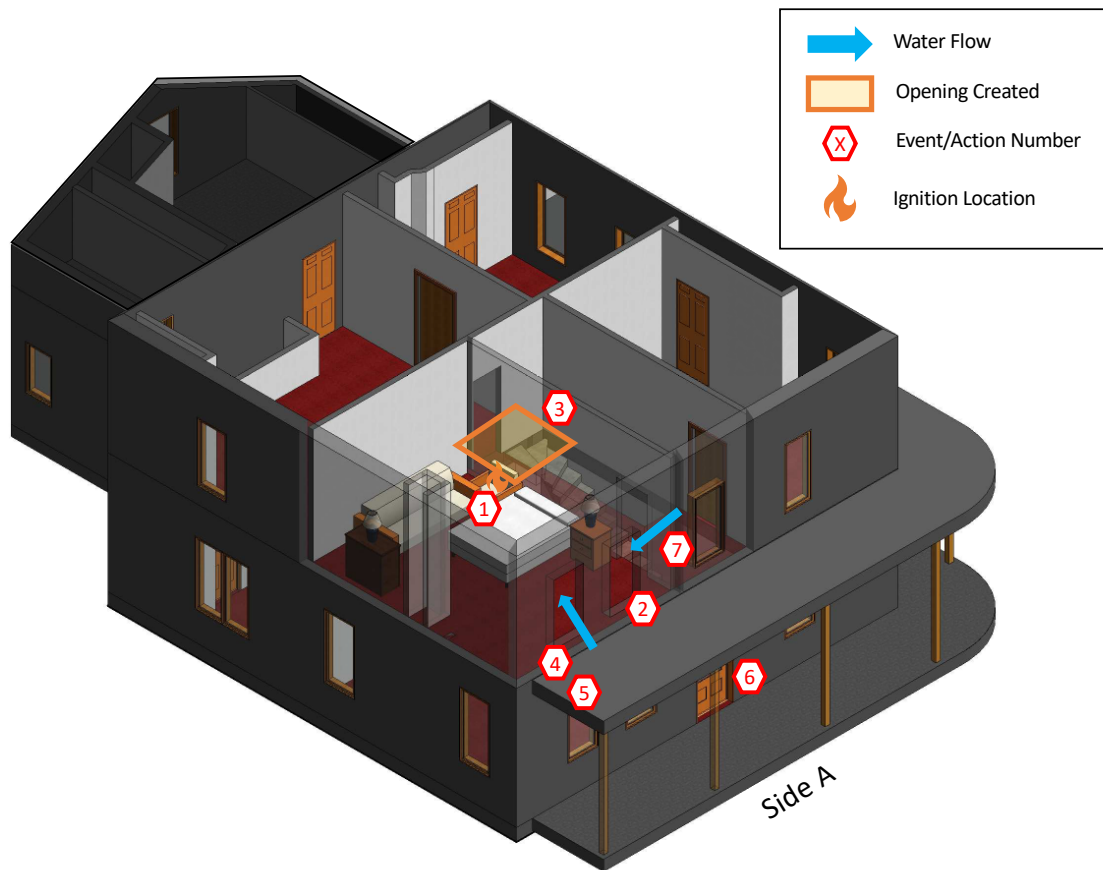

Action/Event	Time (mm:ss)	Time (s)
1 Ignition	00:00	0
2 Flashover	04:21	261
3 Ceiling Failure	06:01	361
4 Exterior Flow - Ceiling	07:01	421
5 Exterior Flow - Lintel	09:02	542
6 Front Door Open	09:42	582
7 Interior Flow	10:36	636

Figure 3.166: Time and sequence of actions and events for Experiment 14.

Thermocouples within the fire room (bedroom 2) recorded fire room temperatures throughout the experiment. Figure 3.167 shows these temperature measurements as a function of time in the fire room. Temperatures 6 ft and above began to increase around 100 s post ignition, corresponding to the accumulation of smoke at the ceiling of the fire room. Temperatures within the fire room increased in descending height from the ceiling, corresponding to the descent of the smoke layer. Just prior to flashover 261 s post ignition, all temperatures within the structure increased. Temperatures during flashover exceed the listed calibration of the thermocouple wire, causing an unknown

increase in uncertainty associated with such measurements for the duration of the experiment. After flashover, temperatures within the fire compartment decreased to a steady state. During steady state, the simulated ceiling failure occurred, causing a small decrease in compartment temperatures 370 s post ignition. The failed ceiling caused hot gases closest to the ceiling to be mixed with cool gases nearest the floor, increasing temperatures within the structure. Temperatures remained steady until the first exterior water flow occurred. Temperatures decreased for an additional 10 s post suppression. After which, temperatures within the space began to increase. A second flashover occurred approximately 510 s post ignition. A post-flashover state was reached before the second exterior water application began at 542 s. Temperatures decreased for approximately 60 s post suppression. Temperatures began to increase just prior to interior water flow at 636 s post ignition. After which, the fire was extinguished and temperatures returned to pre-ignition conditions.

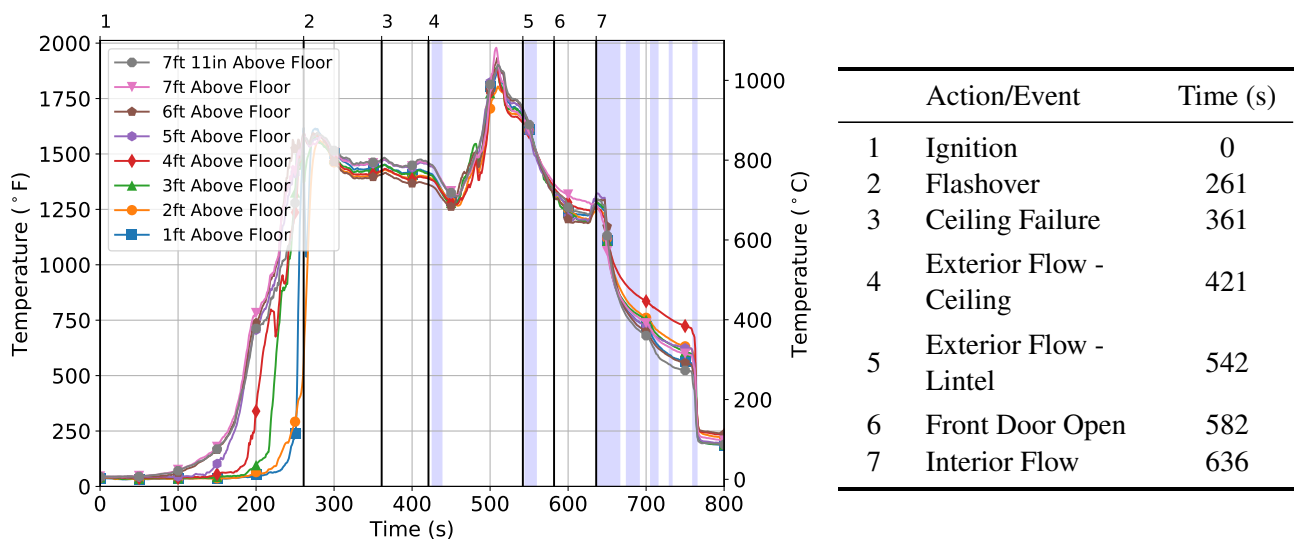
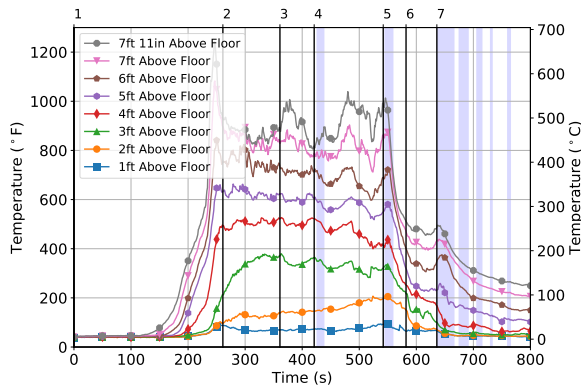

Figure 3.167: Fire room (bedroom 2) temperatures for Experiment 14. Blue vertical bars indicate time and duration of water flow.

Temperatures throughout the structure began to increase as the fire grew. Figure 3.168 presents temperature data collected in remote locations of the structure. Hallway temperatures were greater than the flex space and bedroom 1 temperatures. Hallway Temperatures higher than 3 ft peaked during flashover, but temperatures below continued to increase after the fire room reached flashover. Exterior water directed off the lintel (window header) dropped temperatures through the hallway, with 5 ft and above having the largest decreases. Temperatures in the second-floor flex space also increased just prior to flashover within the fire room. These temperatures did not increase to hallway temperature magnitudes as the flex space was further from the fire room. The door to bedroom 1 remained closed, resulting in lower temperatures during experimentation.



Action/Event	Time (s)
1 Ignition	0
2 Flashover	261
3 Ceiling Failure	361
4 Exterior Flow - Ceiling	421
5 Exterior Flow - Lintel	542
6 Front Door Open	582
7 Interior Flow	636

(a) Hallway Temperatures

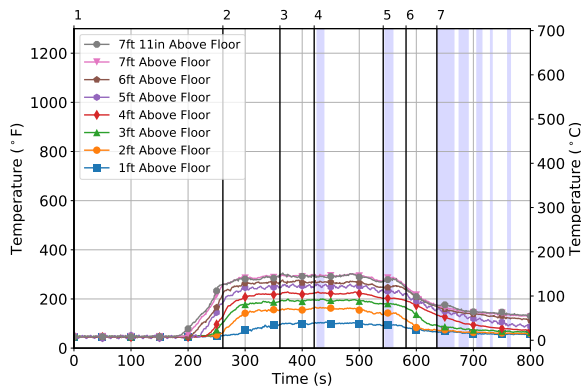

(b) Flex Space Temperatures

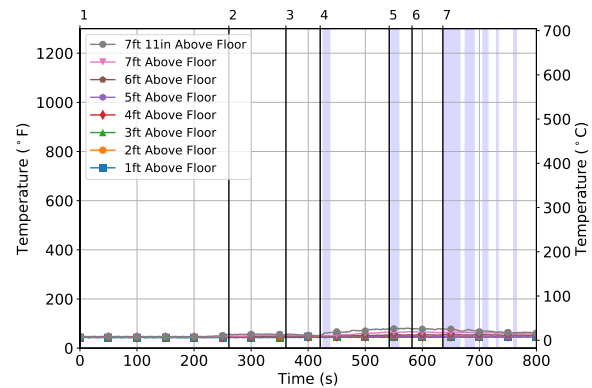

(c) Bedroom 1 Temperatures

Figure 3.168: Second-floor (hallway, flex space, and bedroom 1) temperatures for Experiment 14. Blue vertical bars indicate time and duration of water flow.

As the fire grew, the exchange of hot and cool gases created a pressure differential within the fire room. Figure 3.169 shows the fire room pressure at three elevations during the experiment. At approximately 90 s post ignition, pressures changed as a result of the production of high temperature combustion gases. Prior to flashover, the pressure at the 7 ft elevation increased, the pressure at the 4 ft elevation remained near initial values, and the pressure at the 1 ft elevation decreased.

This indicated a bi-directional flow. Hot gases accumulated at the ceiling, increasing pressure, and exhausted through the room openings. Cool gases were entrained near the floor, decreasing pressure. Post-flashover conditions created steady pressures within the room until the ceiling failed at 361 s. Pressures within the space decreased before becoming steady. Pressures decreased again at approximately 450 s post ignition, corresponding to air entrainment by the fire as it regrew. Pressures increased as the fire regrew at 510 s post ignition, prior to the second exterior suppression at 542 s post ignition. After which, pressures remained steady until interior suppression. Interior suppression affected the sensors, causing failure.

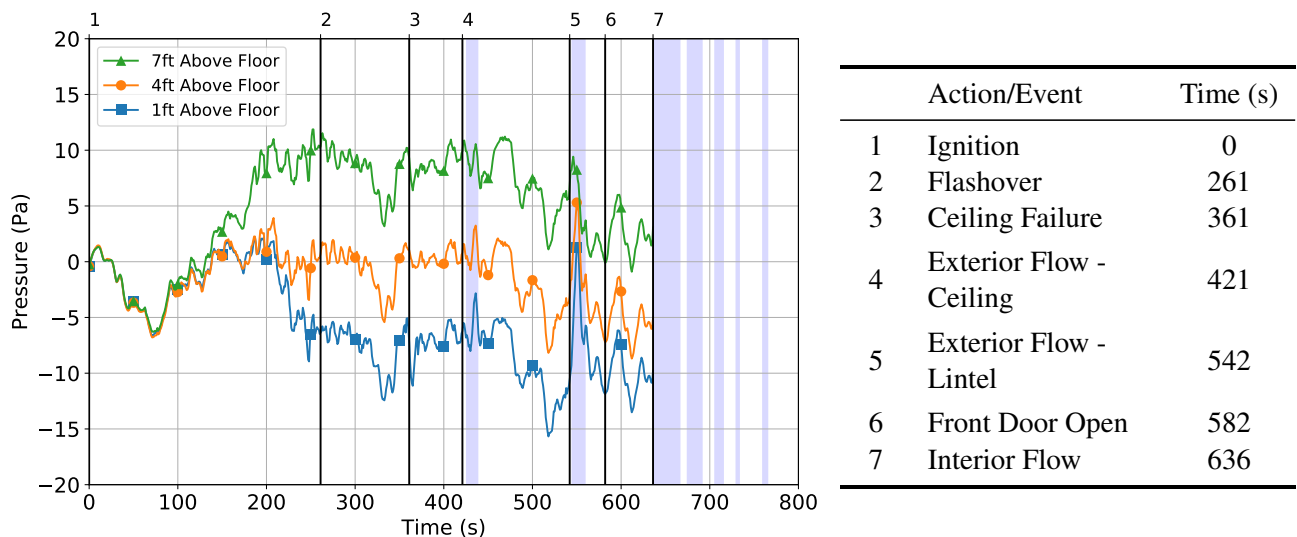
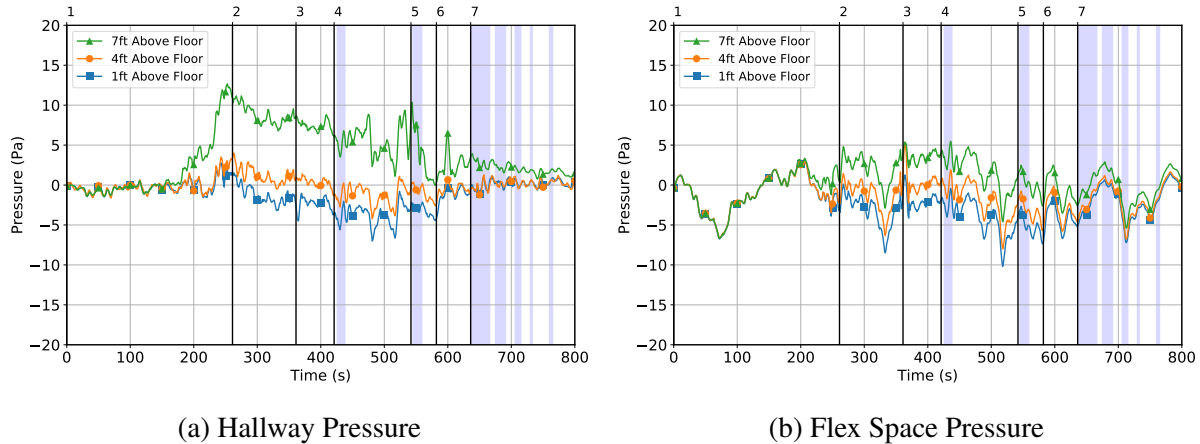

Figure 3.169: Pressures in fire room (bedroom 2) for Experiment 14. Interior suppression caused sensor error. Blue vertical bars indicate time and duration of water flow.

Pressures in the hallway and flex space were also monitored and are presented in Figure 3.170. The pressure in the hallway remained at atmospheric pressure at all three elevations until 190 s post ignition. The pressure at the 7 ft elevation increased as the smoke layer began to descend from the ceiling in the hallway. Pressure at the 4 ft and 1 ft elevations increased just prior to flashover, indicating exhaust of smoke. Post-flashover conditions created a bi-directional flow in the hallway. Pressure at the 7 ft elevation indicated the exhaust of smoke, while the pressure at the 1 ft elevation indicated entrainment of air. The pressure at the 4 ft elevation remained at atmospheric pressure, which indicated the presence of neutral plane. Pressures remained steady until the front door was opened. That ventilation caused the pressure at all three elevations to return toward atmospheric pressure.

All pressures in the flex space began to increase approximately 190 s post ignition. Just prior to flashover, the pressure at the 4 ft and 1 ft elevations decreased, while the 7 ft elevation continued to increase. Pressures remained constant throughout the experiment until the front door was opened at 582 s post ignition. After which, all pressures began returning to near atmospheric pressure.



Action/Event	Time (s)
1 Ignition	0
2 Flashover	261
3 Ceiling Failure	361
4 Exterior Flow - Ceiling	421
5 Exterior Flow - Lintel	542
6 Front Door Open	582
7 Interior Flow	636

Figure 3.170: Pressure remote from fire room for Experiment 14. Blue vertical bars indicate time and duration of water flow.

The pressure differentials between remote locations within the structure led to the production of flow paths. Figure 3.171 indicates the flows within the structure before the front door was opening, after the ceiling failed, and after fire department ventilation of the front door. Prior to fire department intervention, the pressure at the 7 ft elevation in the fire room was greater than the pressure at the 7 ft elevation in the hallway or flex space. Similarly, the pressure at the 1 ft elevation in the fire room was less than the pressure at the 1 ft elevation in the hallway or flex space. These pressure gradients reflect an exchange of cool air into the fire room through the bottom of the doorway in bedroom 2 and hot gases out of the fire room through the top of the doorway. The flow path prior to fire department intervention is illustrated in Figure 3.171a. Initially the only ventilation openings were the fire room windows and doorway. Fresh air was entrained and hot gases were expelled through these openings. After the ceiling failed, a new exhaust vent was established (see Figure 3.171b). After the vertical exhaust vent was established, less gases were exhausted through the fire room windows and doorway, allowing more fresh air to be entrained. The front door was opened, establishing a new inlet vent (see Figure 3.171c). Fresh air was entrained at the front door, which was a more efficient inlet, leading to less flow through the fire room windows.

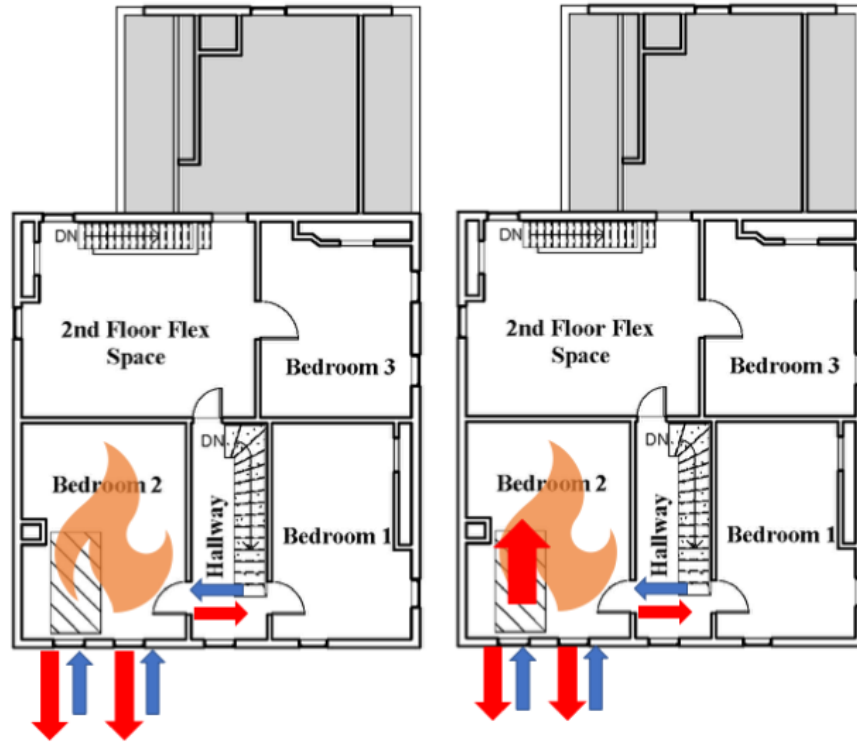

(a) Prior to Front Door Opened

(b) After Failed Ceiling

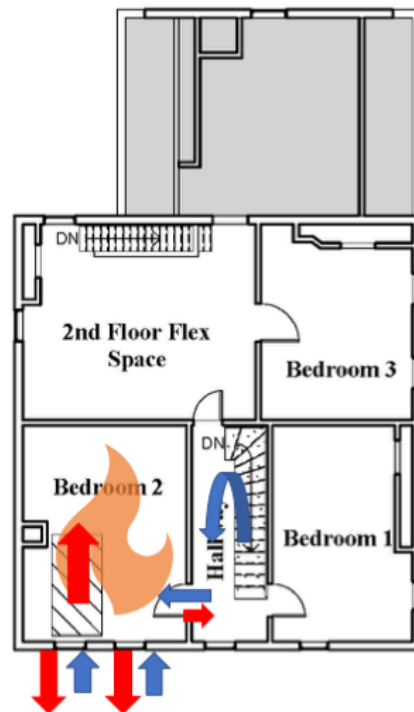

(c) After Front Door Opened

Figure 3.171: Changes in flow path for Experiment 14. Red arrows indicate flow out of the compartment, blue arrows indicate entrainment into the compartment, and the sizes of the arrows indicate the relative magnitude of the flow through each opening.

Heat flux was monitored at the hallway and in the second-floor flex spaces; the data collected is presented in Figure 3.172. The location in the hallway measured heat flux 1 ft above the floor. Heat flux first began to rise approximately 200 s post ignition. The smoke layer in the fire room was approximately at the height of the bed. Just prior to flashover at 261 s post ignition, heat flux at 1 ft peaked and began to decrease. Post-flashover conditions produced a steady heat flux to the location in the hallway. After the exterior water stream directed at the lintel occurred, heat flux decreased to pre-ignition conditions.

The location in the flex space monitored heat flux at two elevations, 1 ft and 3 ft above the floor. Heat flux at both locations remained low until flashover occurred in the fire room at 261 s. The 3 ft elevation gradually increased, peaking just prior to the first exterior water flow directed at the failed ceiling. The 3 ft elevation heat flux steadily decreased until the front door was opened. After which, heat flux at the 3 ft elevation returned to pre-ignition conditions. The 1 ft elevation remained close to 0 kW/m² but increased several times to 1.25 kW/m².

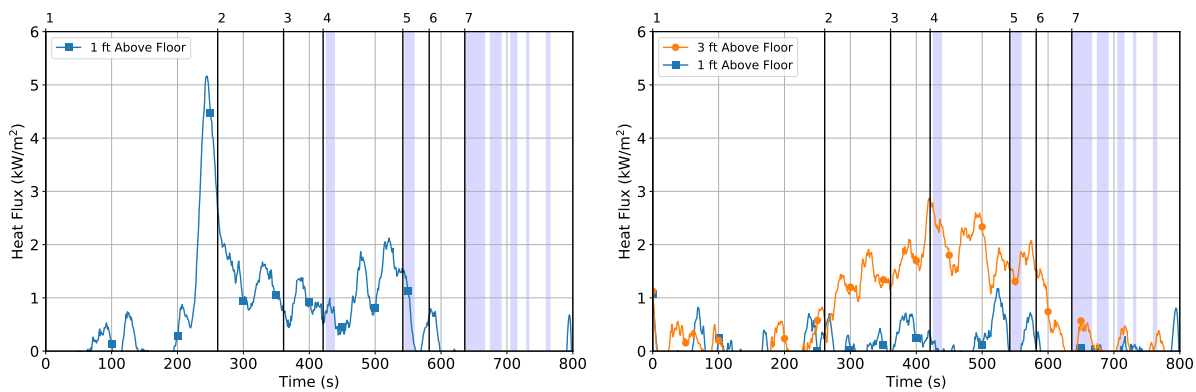

(a) Hallway Heat Flux

(b) Flex Space Heat Flux

Action/Event	Time (s)	
1	Ignition	0
2	Flashover	261
3	Ceiling Failure	361
4	Exterior Flow - Ceiling	421
5	Exterior Flow - Lintel	542
6	Front Door Open	582
7	Interior Flow	636

Figure 3.172: Heat flux versus time in the hallway and flex space for Experiment 14. Blue vertical bars indicate time and duration of water flow.

The aforementioned locations also monitored gas concentrations for CO, CO₂, and O₂ at the respective heights. The gas concentrations in the hallway peaked just after the front door was opened. CO₂ increased to 0.5% and O₂ decreased to 20%, while CO remained unchanged. The gas concentrations in the flex space began to change as flashover occurred in the fire room 261 s post ignition. CO and CO₂ concentrations were greater at the 3 ft elevation than at the 1 ft elevation.

A peak increase of CO₂ and CO occurred simultaneously as O₂ was at its lowest concentration. This occurred between the two exterior water applications. Gas concentrations trended toward pre-ignition conditions after the front door was opened at 582 s post ignition.

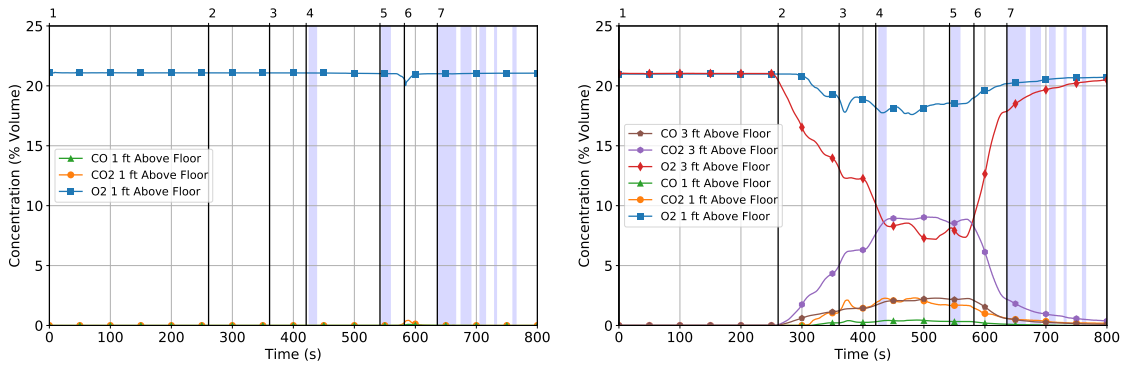

(a) Gas Concentrations in Hallway

(b) Gas Concentrations in Flex Space

Action/Event	Time (s)
1 Ignition	0
2 Flashover	261
3 Ceiling Failure	361
4 Exterior Flow - Ceiling	421
5 Exterior Flow - Lintel	542
6 Front Door Open	582
7 Interior Flow	636

Figure 3.173: Gas concentrations for remote locations in Experiment 14. Blue vertical bars indicate time and duration of water flow.

Kitchen Fires Method 5

3.15 Experiment 15 — Interior Suppression without Additional Ventilation

Experiment 15 was conducted to examine interior suppression without additional ventilation. This was the control experiment for Coordination Method 5. A one-and-a-half-story, single-family home located at 775 Hilltop Road in Xenia, Ohio, was instrumented to conduct this first-floor kitchen fire experiment. Each exterior side of this 1,004 sq ft, wood-framed structure appears in Figure 3.174. The structure was built with rough cut lumber framing with a combination of various wood sidings. The foundation was a mix of poured concrete and concrete block. The peaked roof was constructed using 1 in.-by-6 in. sheathing covered with asphalt shingles. Interior wall finishes included a combination of plaster and lath, plasterboard (kitchen), gypsum wallboard, and wood paneling (flex space), while interior floor finishes were a combination of tile (kitchen) and carpet (flex space, etc.). Detailed dimensioned drawings for the first and second floor appear in Appendix Figures B.10 and B.11, respectively.



Figure 3.174: Exterior photographs of the structure for Experiment 15.

The experimental volume of the structure included all spaces on the first and second-floors except the first-floor bathroom. The first-floor bathroom was separated from the experimental volume of the structure and used to protect instrumentation. This experiment utilized the first-floor kitchen as the fire room. The structure was instrumented for temperature, pressure, heat flux, IR, and standard video to capture the fire dynamics during experimentation. Instrumentation was also installed to characterize the potential for skin burns and occupant toxic exposure during the experiment. The layout of the first and second-floors with the instrumentation locations are shown in Figure 3.175.

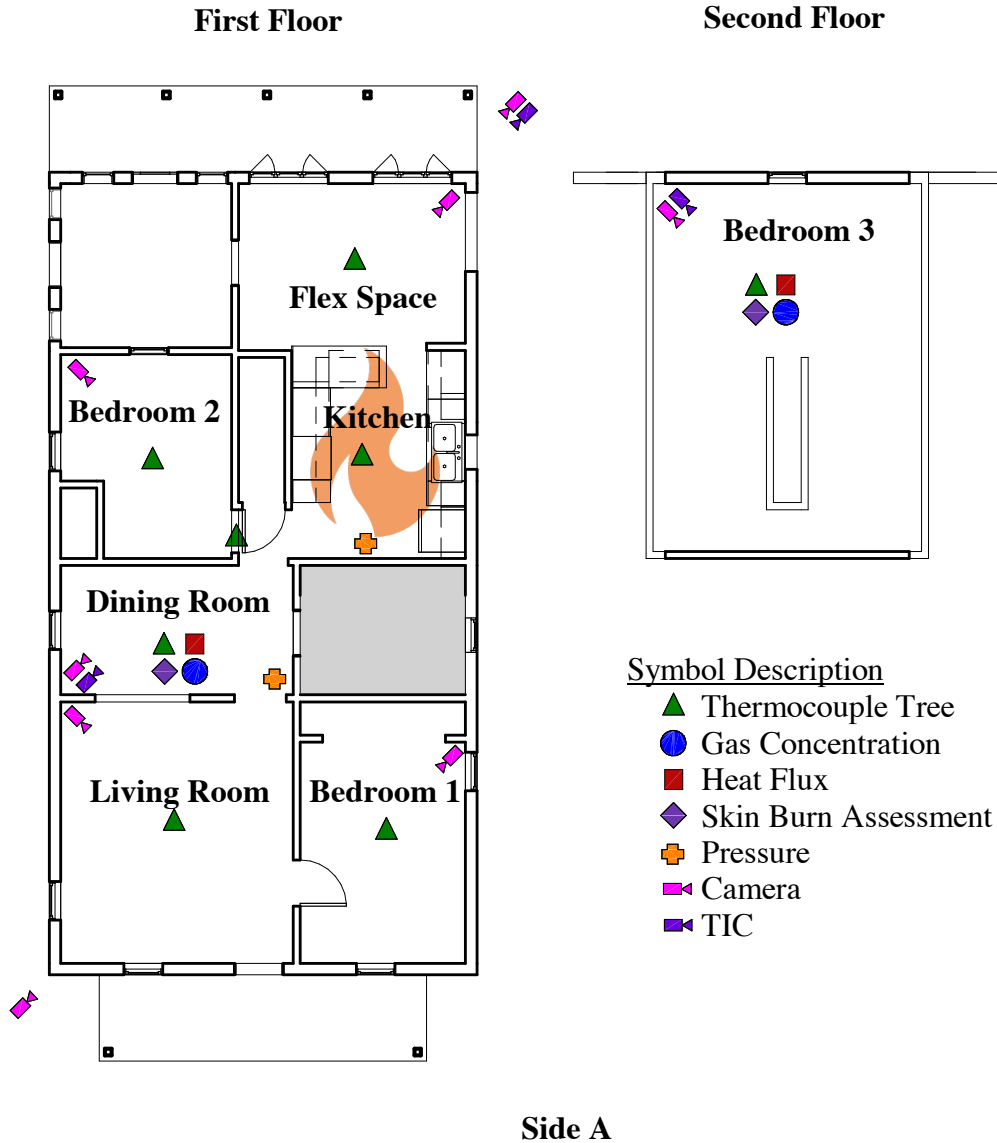

Figure 3.175: Instrumentation and floor plan for Experiment 15. The gray area was isolated from the remainder of the structure and utilized as space for instrumentation.

The fire room (kitchen) was located along side D of the home. The fire room was open to the vestibule connecting the stairwell, bedroom 2, the dining room, and the flex space located in the C/D corner. The flex space contained a table and two chairs.

To have consistent pre-ignition ventilation compared to the other experiments and to provide sufficient oxygen needed for flashover, two windows were removed prior to ignition. The first window was located along side D of the fire room (labeled 14 in Figure 3.176), and the second window was located along side D of the flex space (labeled 13 in Figure 3.176). A dimensioned layout of the kitchen and flex space are included in Figure 3.176.

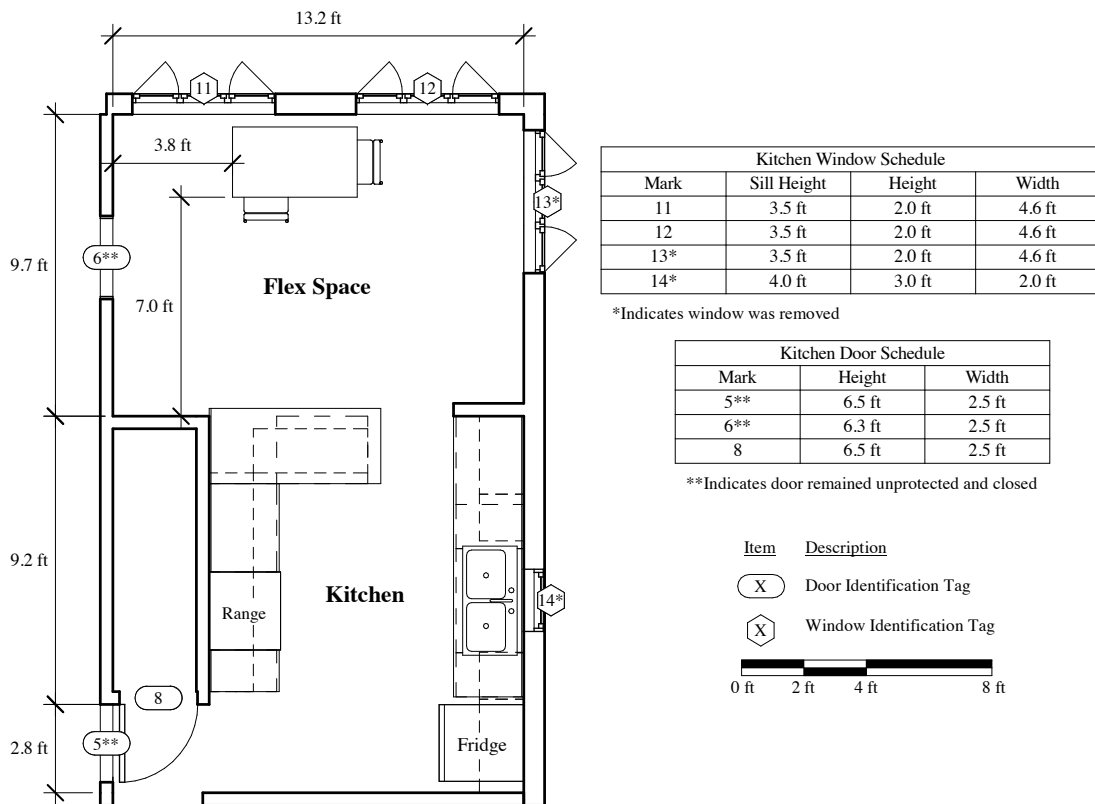

Figure 3.176: Fire room and flex space layout for Experiment 15.

The kitchen was furnished with the fuel package described in Section 2.4.2 and contained a range and a refrigerator. The ignition location was surrounded by 1250 paper cups, a coffee maker, and six paper towel rolls. The paper cups were distributed between the counter top and the open wall cabinets above the ignition location. Four additional paper towel rolls were located on top of the refrigerator. Figure 3.177 presents the fuel package.



Figure 3.177: Photograph of the fuel package for Experiment 15.

The furnishings in the kitchen included pre-existing wood cabinetry. Wall and base cabinets were located against the perimeter of the kitchen on sides B, C, and D. Wall cabinets were 26 in. high by 17 in. deep, and the base cabinets were 36 in. high by 26 in. deep. A detailed drawing of these cabinets are included in Figure 3.178.

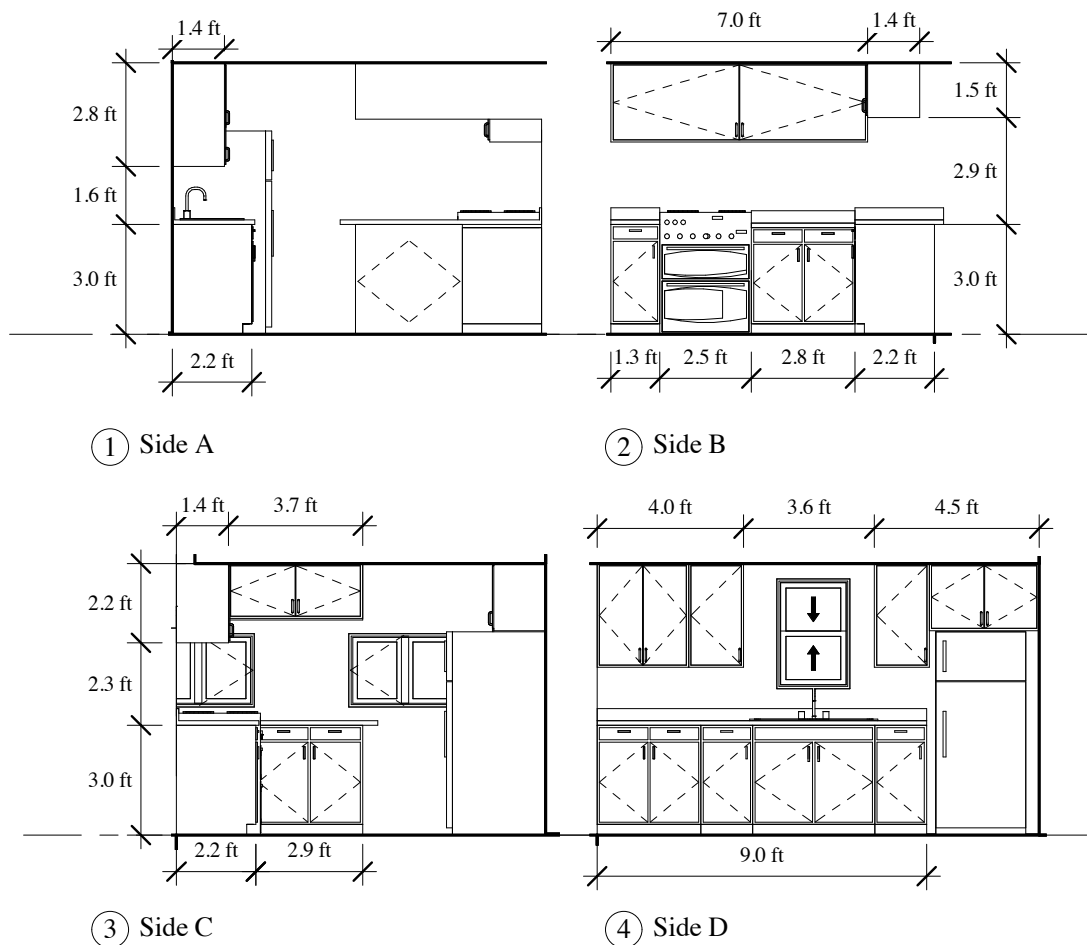
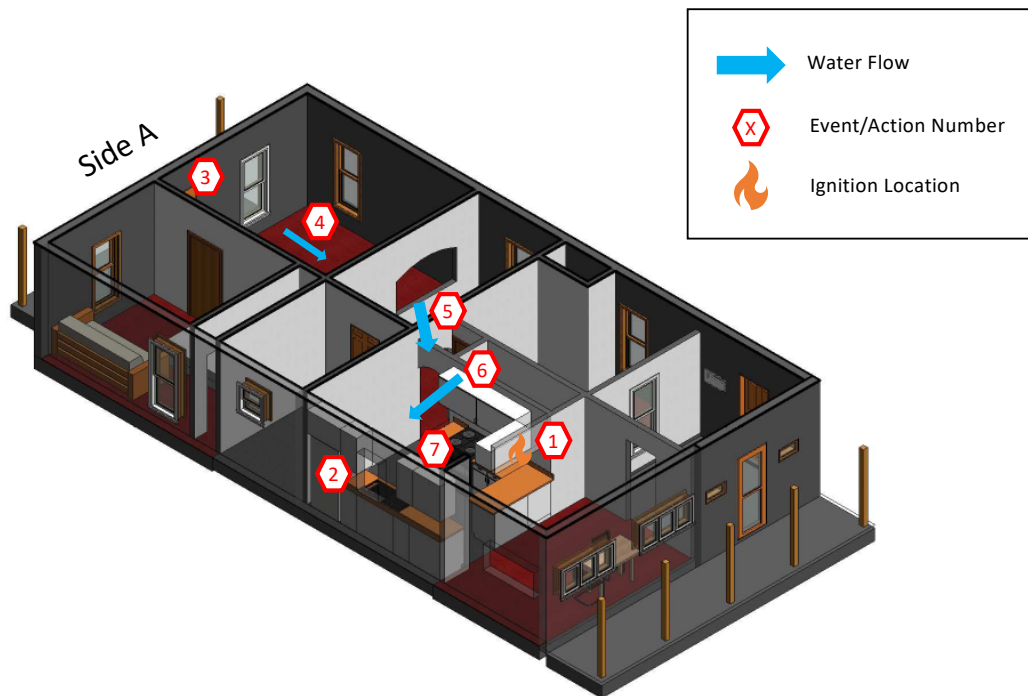

Figure 3.178: Wall and base cabinet locations, dimensions, and elevations within the kitchen for Experiment 15.

The fire was ignited in the cluster of cups and paper towels located on the kitchen counter ($t = 0$ s). Once the fire was ignited and flashed over (294 s (4:54) post ignition), fire department interventions began. The ventilation crew opened the front door 360 s (6:00) post ignition. The suppression crew entered the structure 8 s later and advanced a 1.75 in. hoseline with a combination nozzle set to straight stream into the living room. The nozzle operator flowed water for 2 s, 378 s (6:18) post ignition. The suppression crew advanced into the dining room and flowed water for 12 s, 389 s (6:29) post ignition. The crew advanced to the kitchen doorway and flowed water for 14 s, 410 s (6:50) post ignition. Final suppression began 436 s (7:16) post ignition as the suppression crew made entry into the kitchen.

From front door open to fire room entry, the total tactic duration was 75 s (1:15). The total water flowed for initial suppression was 99 gal, which does not include the additional water used during mop-up operations. The location and sequence of events are presented in Figure 3.179.



Action/Event	Time (mm:ss)	Time (s)
1 Ignition	00:00	0
2 Flashover	04:54	294
3 Front Door Open	06:00	360
4 Flow from Living Room	06:18	378
5 Flow from Dining Room	06:29	389
6 Flow from Kitchen Doorway	06:50	410
7 Suppression Crew Entered Fire Room	07:16	435

Figure 3.179: Time and sequence of actions and events for Experiment 15.

Figure 3.180 shows the time history of the temperature variations within the fire room and attached flex space. Kitchen temperatures (see Figure 3.180a) nearest the ceiling began to increase 25 s post ignition as products of combustion began to accumulate. Temperatures 5 ft and below began to increase approximately 70 s post ignition, as flames reached the ceiling in the kitchen. The fire grew to flashover 294 s post ignition, indicated by floor temperatures exceeding 1100 °F. Post-flashover, ceiling temperatures decreased to 1475 °F and floor temperatures decreased to 1150 °F. The opening of the front door provided additional ventilation to the structure. Fresh air entrainment through this opening caused the heat release rate of the fire to increase. Temperatures continued to steadily increase until water flow from the living room was initiated. Flow from the living room at 376 s post ignition results in a drop in temperature to below 500 °F.

Because the flex space was open to side C of the kitchen, temperatures within this space increased

as kitchen temperatures increased. Flex space ceiling temperatures (see Figure 3.180b) increased 50 s post ignition, as smoke accumulated at the kitchen ceiling spilled into the flex space. Temperatures nearest the floor increased 100 s post ignition. Similar to kitchen temperatures, temperatures at all elevations had a sharp rise during the 30 s prior to flashover of the kitchen. Unlike conditions within the kitchen, the flex space did not achieve flashover, as temperatures nearest the floor peaked to 790 °F, 302 s post ignition. After the kitchen reached flashover, temperatures within the flex space decreased to a steady state. Temperatures within this space increased with additional ventilation from the front door being opened. Temperatures at the floor reached 660 °F and temperatures at the ceiling reached 1075 °F. Suppression from the living room decreased temperatures below 600 °F (Action 6). Extinguishment of the kitchen fire caused temperatures to permanently decrease (Action 7).

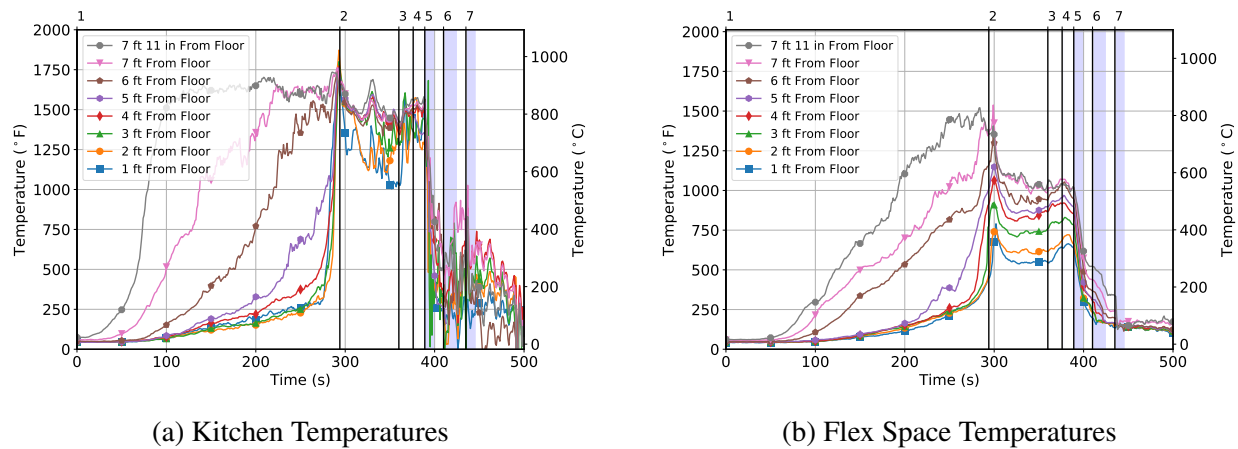

Action/Event	Time (s)	
1	Ignition	0
2	Flashover	294
3	Front Door Open	360
4	Flow from Living Room	376
5	Flow from Dining Room	389
6	Flow from Doorway	410
7	Suppression Crew Entered Fire Room	435

Figure 3.180: Temperatures in fire room (kitchen) for Experiment 15. Temperature measurements post suppression were compromised by the water flow of the interior hoseline. The flow from the hoseline dislodged the thermocouple array from its anchor point at approximately 400 s. Blue vertical bars indicate time and duration of water flow.

First-floor temperatures remote from the fire room (kitchen) began to increase relative to their proximity to the fire room (temperature data presented in Figure 3.181). Dining room (see Figure 3.181a) and living room (see Figure 3.181b) ceiling temperatures (7 ft and above) began to increase as smoke spread throughout the structure. Approximately 100 s after the ceiling temperatures increased, temperatures lower in elevation began to increase as the smoke layer filled the space. These remote locations reached a steady elevated temperature after flashover in the kitchen,

which remained the case until fire department interventions. Temperatures within the dining room ranged from 175 °F at the floor to 1100 °F at the ceiling, while temperatures in the living room ranged from 90 °F at the floor to 530 °F at the ceiling. In these areas, the open front door caused temperatures nearest the floor, 5 ft and below in the dining room, and 6 ft and below in the living room, to decrease. The entrainment of air from the front door brought cool air into these spaces. Temperatures nearest the ceiling increased similar to the kitchen and flex space, additional ventilation allowed the fire to grow producing more products of combustion. Temperatures in both of these spaces decreased after suppression in the dining room occurred and continued to decrease with suppression in the living room and fire room doorway. Extinguishment of the kitchen fire resulted in temperatures returning to pre-ignition conditions.

The kitchen fire began to exhaust hot products of combustion into adjacent areas of the structure 150 s post ignition. These hot gases traveled up the stairwell into bedroom 3, causing temperatures (see Figure 3.181c) 4 ft and above to increase. All temperatures within bedroom 3 began to increase 200 s post ignition. The temperatures increased at a greater rate approximately 30 s prior to kitchen flashover, 294 s post ignition. Kitchen flashover caused temperatures to peak; ceiling temperatures reached 760 °F and floor temperatures reached 170 °F. After the kitchen transitioned through flashover, temperatures reached a range of 200 °F to 560 °F until suppression in the living room.

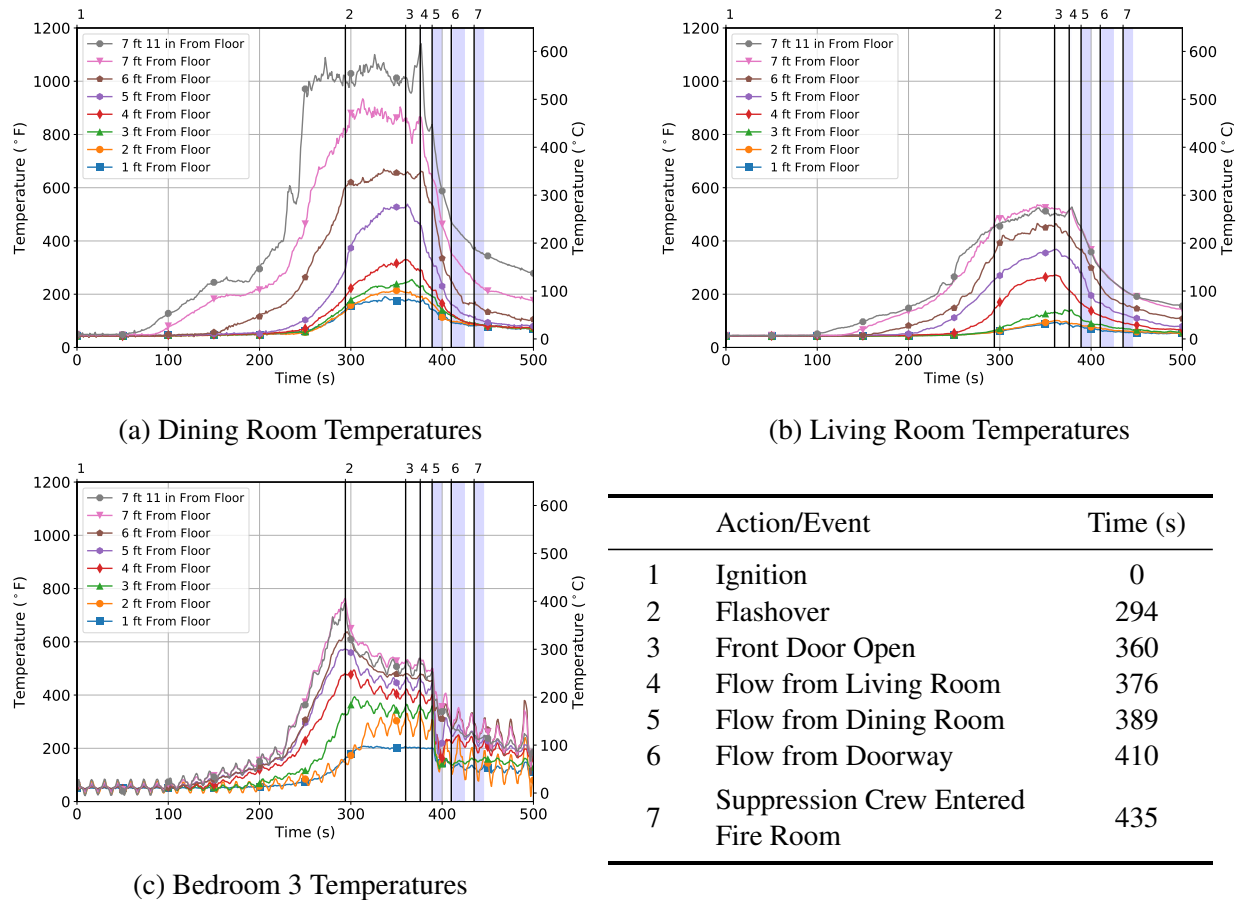

Figure 3.181: Temperatures remote from the fire room (kitchen). Blue vertical bars indicate time and duration of water flow.

The kitchen pressures, displayed in Figure 3.182, began to deviate from ambient at approximately 50 s post ignition. The pressure 7 ft above the floor increased due to gas expansion of the combustion products that began to fill the kitchen. The pressure 1 ft above the floor began to decrease approximately 100 s post ignition as cool air was entrained into the fire room. As the fire approached flashover, the pressure at the 4 ft elevation started to increase as the hot gas layer descended from the ceiling. During flashover, the 7 ft and 4 ft pressures peaked to 12.4 Pa and 3.6 Pa, respectively. After flashover, all kitchen pressures remained relatively constant at approximately 10.0 Pa, 2.0 Pa, and -7.0 Pa, respectively, until suppression.

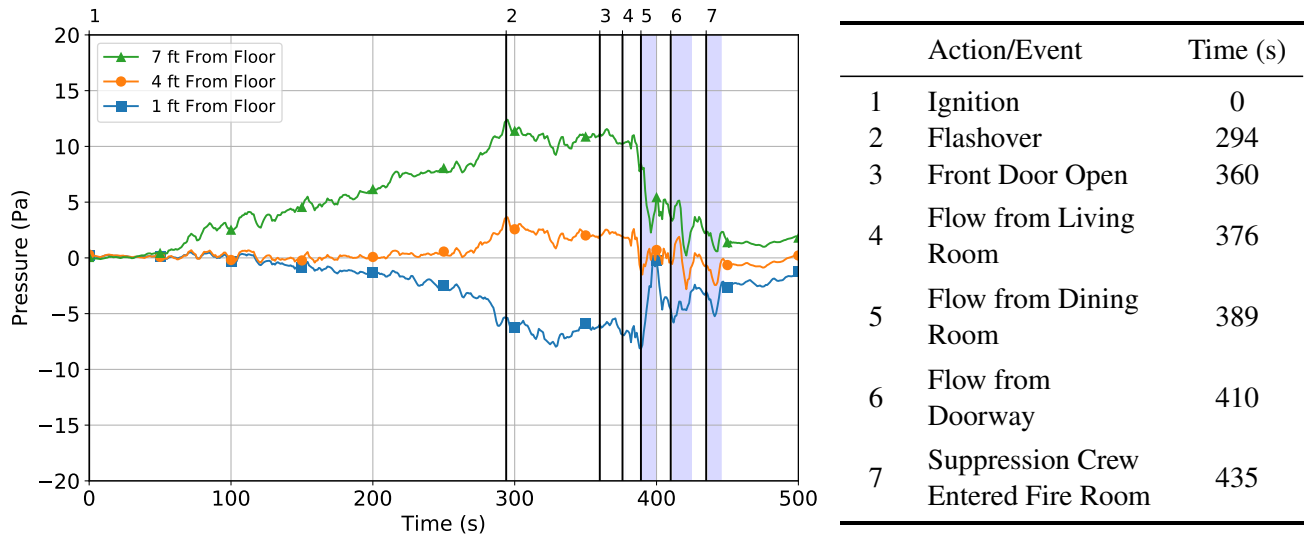
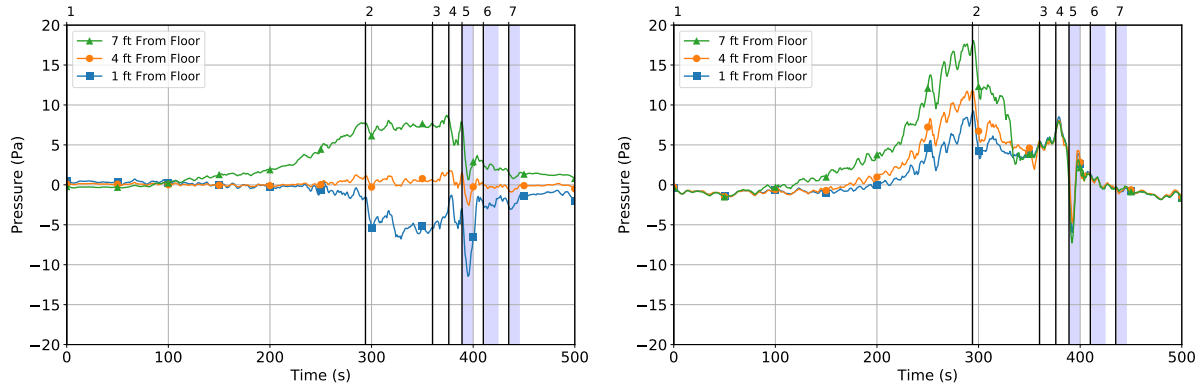

Figure 3.182: Pressures in the fire room (kitchen) for Experiment 15. Blue vertical bars indicate time and duration of water flow.

Pressure data measured in remote locations in the structure is presented in Figure 3.183. Pressures in the dining room began to change approximately 100 s post ignition (see Figure 3.183a). The pressure at the 7 ft elevation began to increase as the hot gases began to flow into the dining from the kitchen. The pressure at the 1 ft elevation began to decrease approximately 250 s, post ignition, as air was entrained to the fire room. The pressure at the 4 ft elevation remained relatively constant over the duration of the experiment, indicating there was a neutral plane approximately 4 ft above the floor. Post-flashover conditions created steady pressures at approximately 7.0 Pa, 1.0 Pa, and -5.0 Pa, respectively. Interior suppression returned pressures to near ambient conditions.

An increase in pressure in bedroom 3 (see Figure 3.183b) also occurred approximately 100 s post ignition. However, unlike the kitchen and dining room, the pressure at all three elevations in bedroom 3 increased. Pressures peaked during flashover to 18.0 Pa, 12.0 Pa, and 9.0 Pa, respectively. All three elevations showed an increase in pressure from the front door ventilation, peaking to 8.5 Pa. The buoyant, hot gases rose and naturally pressurized the second-floor.



(a) Dining Room Pressures

(b) Bedroom 3 Pressures

	Action/Event	Time (s)
1	Ignition	0
2	Flashover	294
3	Front Door Open	360
4	Flow from Living Room	376
5	Flow from Dining Room	389
6	Flow from Doorway	410
8	Suppression Crew Entered Fire Room	435

Figure 3.183: Pressures remote from the fire room (kitchen) for Experiment 15. Blue vertical bars indicate time and duration of water flow.

Diagrams expressing the flow paths within the structure are presented in Figure 3.184 as a function of ventilation. The fire growth in the kitchen created bi-directional flows throughout the structure. Initially, hot gases flowed away from fire and cool gases were entrained in low (see Figure 3.184a). Prior to fire department interventions, the pressure at the 7 ft elevation in the fire room (kitchen) was greater than the pressure at the same height in the remote room (dining room). Similarly, the pressure at the 1 ft elevation in the fire room was less than the pressure at the same height in the remote room. These pressure changes reflect an exchange of cool air into the fire room through the bottom of the kitchen doorway and hot gases out of the fire room through the top of the doorway. The fire room and kitchen doorway were bi-directional vents. Opening the front door (see Figure 3.184b) provided a new inlet for fresh air to be entrained. The air entrainment through the front door decreased the air entrainment from the kitchen windows, leading to increased hot gas exhaust. Additional exhaust flow was established through the front door.

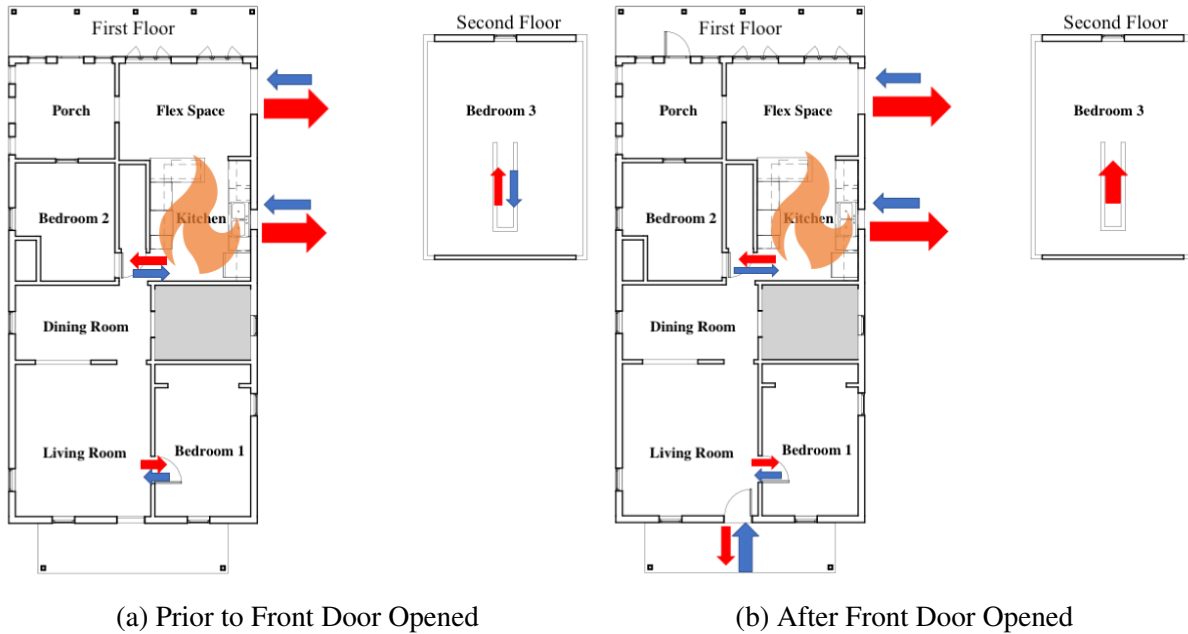
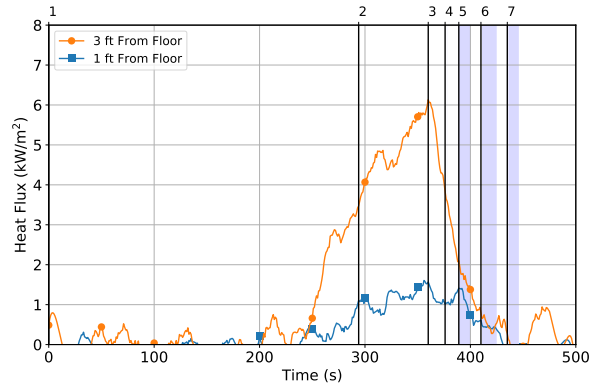

Figure 3.184: Changes in flow during Experiment 15. Red arrows indicate the flow of combustion products, the blue arrows indicate the flow of fresh air, and the sizes of the arrows indicate the relative magnitude of the flow.

Heat flux data recorded in remote locations within the structure are presented in Figure 3.185. Dining room heat flux (see Figure 3.185a) began to increase in the minute before flashover. Heat flux steadily increased, peaking at the time the front door was opened to 1.6 kW/m^2 and 6.0 kW/m^2 at the 1 ft and 3 ft elevations, respectively. Once the door was opened, the hot gas layer exhausted out of the structure, decreasing the heat flux at the measured locations. Heat flux returned to pre-ignition conditions after interior water flow.

Bedroom 3 heat flux (see Figure 3.185b) began to increase 250 s post ignition. The heat flux peaked during flashover to 4.5 kW/m^2 . Post-flashover heat flux at this elevation decreased to a steady 1.0 kW/m^2 prior to front door ventilation. As interior water flow occurred, heat flux in bedroom 3 briefly increased to approximately 2.2 kW/m^2 , then decreased to near pre-ignition values.



(a) Dining Room Heat Fluxes

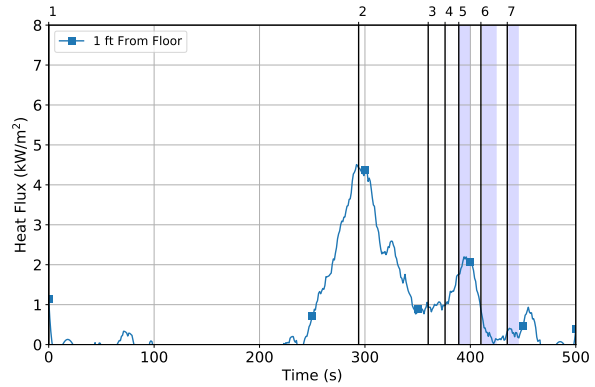

(b) Bedroom 3 Heat Fluxes

	Action/Event	Time (s)
1	Ignition	0
2	Flashover	294
3	Front Door Open	360
4	Flow from Living Room	376
5	Flow from Dining Room	389
6	Flow from Doorway	410
8	Suppression Crew Entered Fire Room	435

Figure 3.185: Heat flux in remote locations for Experiment 15. Blue vertical bars indicate time and duration of water flow.

Gas concentration data for remote locations within the structure are presented in Figure 3.186. Dining room gas concentrations (see Figure 3.186a) began to change approximately 30 s before flashover occurred. The greatest concentration of CO and CO₂ and least concentration of O₂ were measured at the 3 ft elevation in the dining room and occurred approximately 8 s after the front door was opened: 6.6% CO, 1.8% CO₂, and 15.5% O₂. Opening the front door affected gas concentrations at the 3 ft elevation but not at the 1 ft elevation. Suppression decreased gas concentrations of CO and CO₂ and increased O₂ concentration at both elevations in the dining room.

Gas concentrations within bedroom 3 (see Figure 3.186b) did not begin to change until after the front door was opened and suppression efforts were initiated. Gas concentrations peaked at 0.2% CO, 1.2% CO₂, and 20.0% O₂ before returning to pre-ignition conditions after interior water flow was completed.

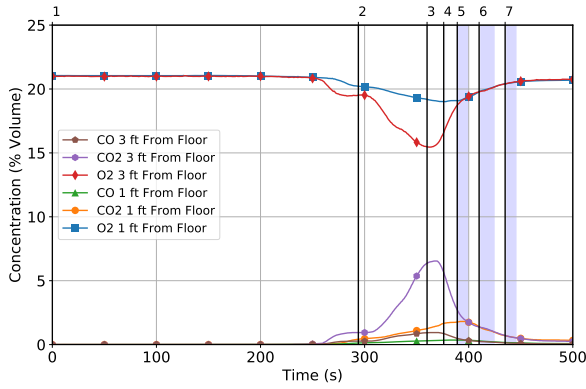

(a) Dining Room Gas Concentrations

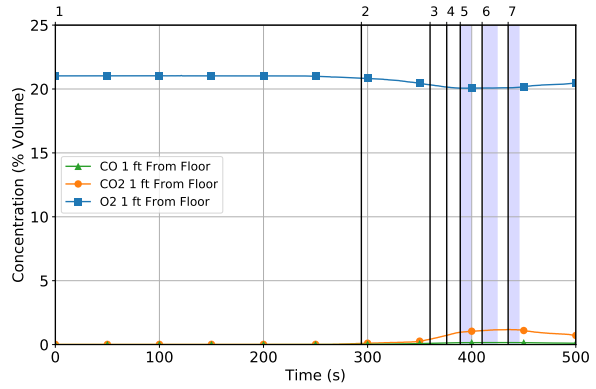

(b) Bedroom 3 Gas Concentrations

	Action/Event	Time (s)
1	Ignition	0
2	Flashover	294
3	Front Door Open	360
4	Flow from Living Room	376
5	Flow from Dining Room	389
6	Flow from Doorway	410
8	Suppression Crew Entered Fire Room	435

Figure 3.186: Gas concentrations in remote locations in Experiment 15. Figure 3.186b ends at 500 s to show that gas concentrations returned to pre-ignition values in bedroom 3. Blue vertical bars indicate time and duration of water flow.

3.16 Experiment 16 — Interior Suppression with Additional Horizontal Ventilation

Experiment 16 was conducted to examine the impact of additional horizontal ventilation prior to interior suppression. A one-story, single-family home located at 773 Hilltop Road in Xenia, Ohio, was instrumented to conduct this kitchen fire experiment. Exterior photos of this 1,169 sq ft, wood-framed structure are presented in Figure 3.187. The structure was built with rough cut lumber framing with a combination of various vinyl sidings and stone facade. The foundation was a mix of poured concrete and concrete block. The gable style roof was constructed using 1 in.-by-6 in. sheathing covered with asphalt shingles. Interior walls and ceilings were constructed with lath finished with plaster skim in the kitchen and drywall in all other areas. Floor finishes included carpet in the kitchen and wood in bedroom 1, while the living and dining room floors were left unfinished. Detailed dimensioned drawings for the structure appear in Appendix Figure B.9.



Figure 3.187: Exterior photographs of the structure for Experiment 16.

The structure had a living room, dining room, kitchen, and bedroom. These areas formed the experimental volume of the structure, accounting for 649 sq ft. The remaining areas within the

structure were separated from this volume and used as instrumentation space. This experiment utilized the first-floor kitchen as the fire room. The structure was instrumented for temperature, pressure, heat flux, IR, and standard video to capture the fire dynamics during experimentation. Instrumentation was also installed to characterize the potential for skin burns and occupant toxic exposure during the experiment. The layout of the structure is presented by Figure 3.188.

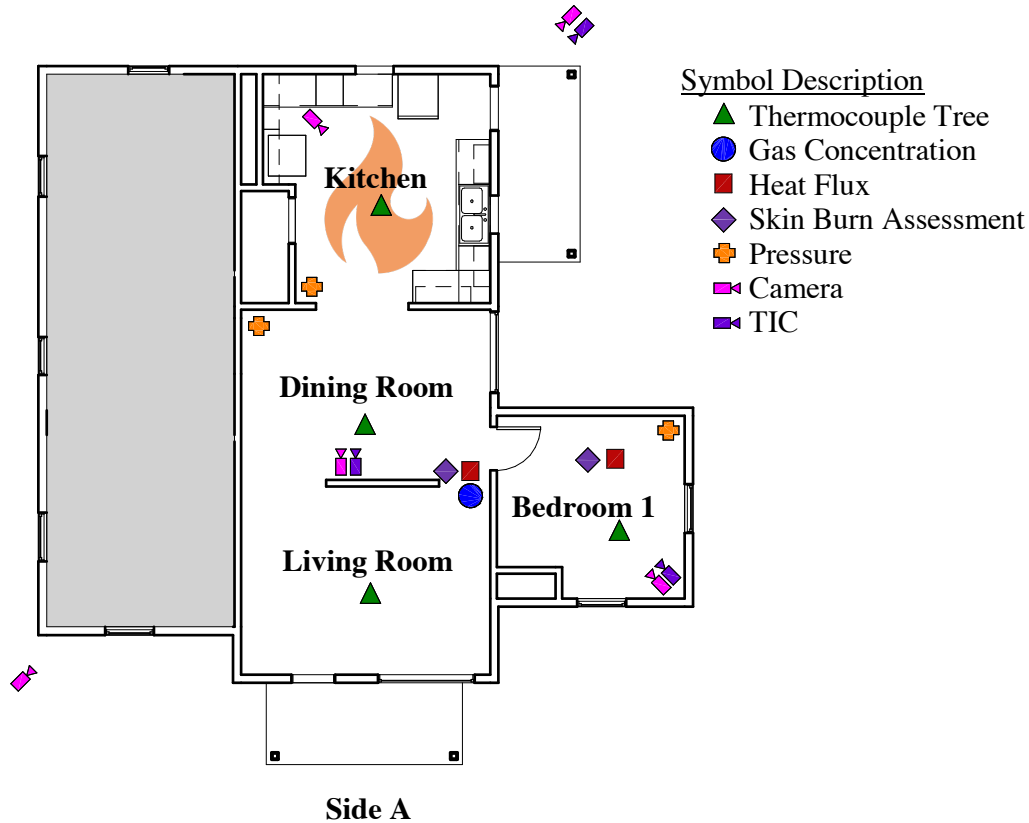

Figure 3.188: Instrumentation and floor plan for Experiment 16. The gray area was isolated from the remainder of the structure and utilized as space for instrumentation.

The fire room (kitchen) was located in the C/D corner of the structure. The fire room was open to the adjacent dining room, which was furnished with a table and two chairs. The kitchen windows, located on side C and side D, were removed prior to ignition to allow for sufficient ventilation to support flashover in the kitchen. The single exterior door located on side D remained closed for the duration of the experiment.

The fire room was furnished with the kitchen fuel package described in Section 2.4.2 and contained a range and refrigerator. The ignition location was surrounded by a large bag of potato chips, a coffee maker, and four paper towel rolls. The wall cabinets located above the ignition location contained approximately 1250 paper cups and eight paper towel rolls. Two additional paper towel

rolls were located on top of the refrigerator. Photographs of the fire room containing the fuel package prior to ignition are presented in Figure 3.189. A dimensioned layout of the kitchen is included in Figure 3.190.



(a) Side A

(b) Side C



(c) Side D

Figure 3.189: Interior photographs of the fire room for Experiment 16.

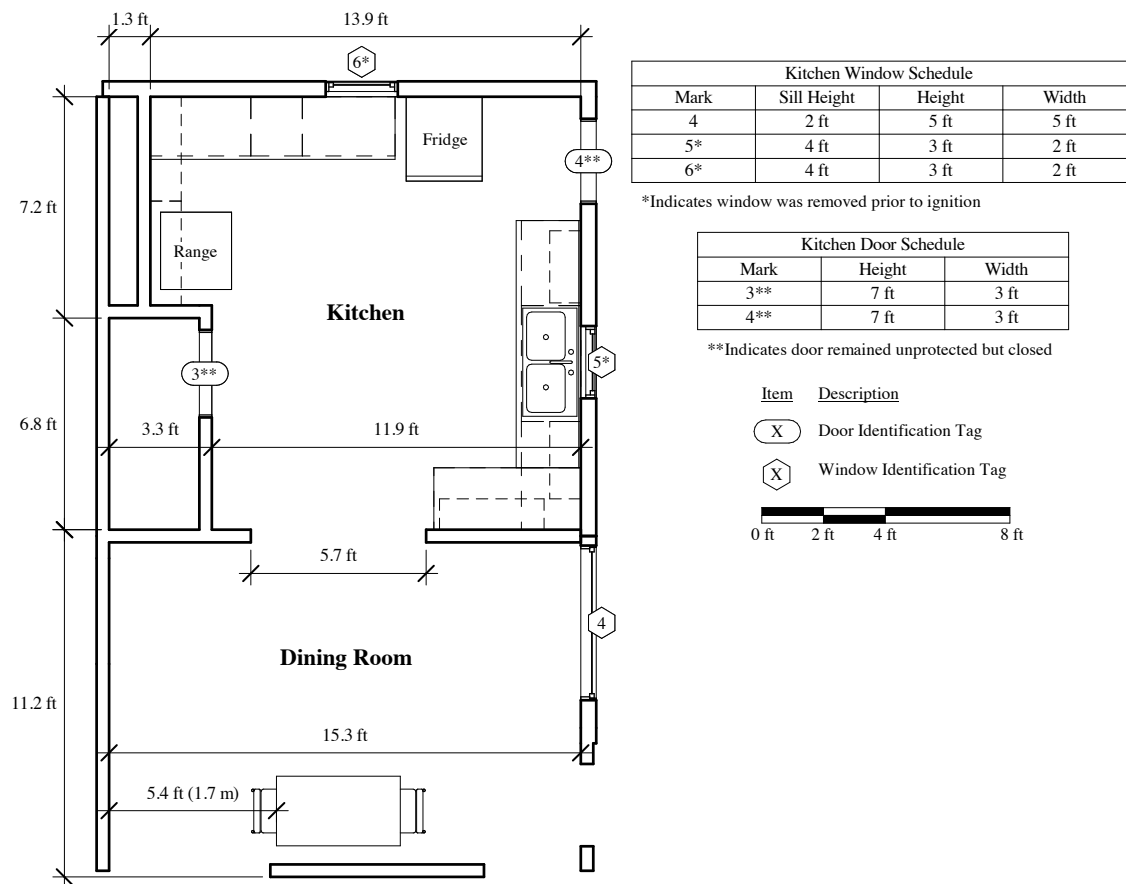

Figure 3.190: Fire room layout for Experiment 16.

The kitchen was furnished with wood cabinets. Wall and base cabinets were located against the perimeter of the kitchen along the side C and side D walls. Wall cabinets were located on the side B wall over the range and were 38 in. high and 12 in. deep. The base cabinets were 35 in. high and 23 in. deep. The cabinets directly above the ignition location were left partially open. A detailed drawing of the kitchen cabinets is included in Figure 3.191.

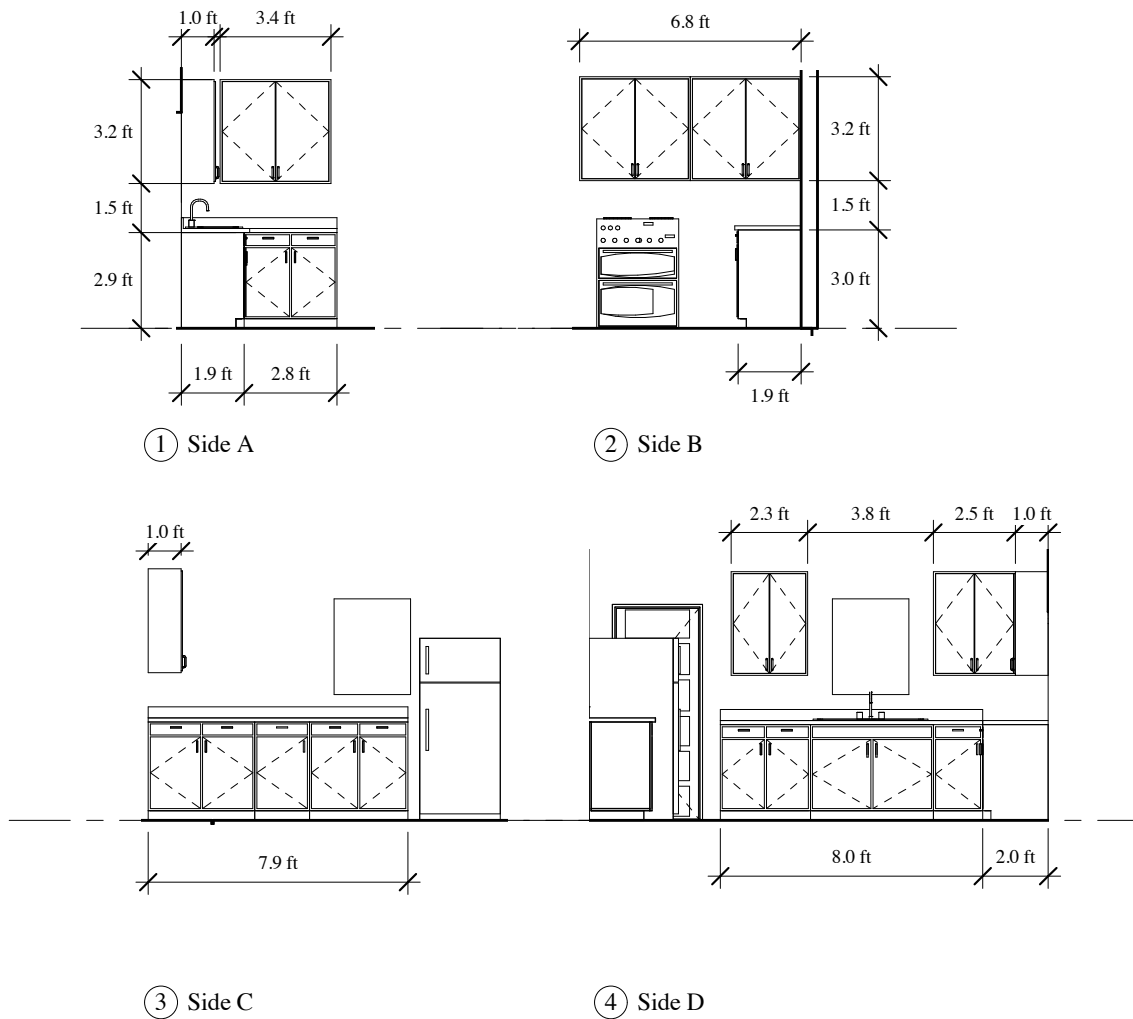

Figure 3.191: Wall and base cabinet locations, dimensions, and elevations within the kitchen for Experiment 16.

Horizontal ventilation was provided by breaking a 71 in. by 61 in. window located on side A of the structure. The remote window location was 22.5 ft from the kitchen. Photographs of the side A window before and after ventilation are presented in Figure 3.192.



(a) Before Ventilation

(b) After Ventilation

Figure 3.192: Photographs of the additional horizontal ventilation for Experiment 16.

The ignition package located on the counter in the A/D corner of the kitchen was ignited to begin the experiment ($t = 0$ s). Flames were first visible from the side D window (labeled 5 in Figure 3.190) 120 s (2:00) post ignition. However, flames did not pass the threshold of the side D window until 470 s (7:50) post ignition. Flames surpassed the side C window (labeled 6 in Figure 3.190) approximately 525 s (8:45) post ignition. The fire room reached flashover 532 s (8:52) post ignition.

The ventilation crew opened the front door 600 s (10:00) post ignition and began horizontal ventilation on side A 611 s (10:11) post ignition. The suppression crew entered the structure through the front door and began flowing water 626 s (10:26) post ignition. A combination nozzle set to straight stream attached to a 1.75 in. hoseline was utilized for interior suppression. The nozzle operator opened the bale completely and flowed water for approximately 3 s. The nozzle operator then closed the bale approximately halfway while flowing water for an additional 32 s. During this time, the suppression crew made their way to the doorway of the kitchen, and then the bale was opened completely and water was flown for an additional 44 s. The total flow time for the first water application was 79 s. The crew then entered the fire room and the second water application occurred 742 s (12:22) post ignition and lasted 19 s. The total tactic time from front door ventilation to fire room entrance was 128 s (2:08). The total water flowed for initial suppression was 217 gal. This value does not include additional water used for mop-up operations. The sequence of events with an isometric image of the structure are presented in Figure 3.193.

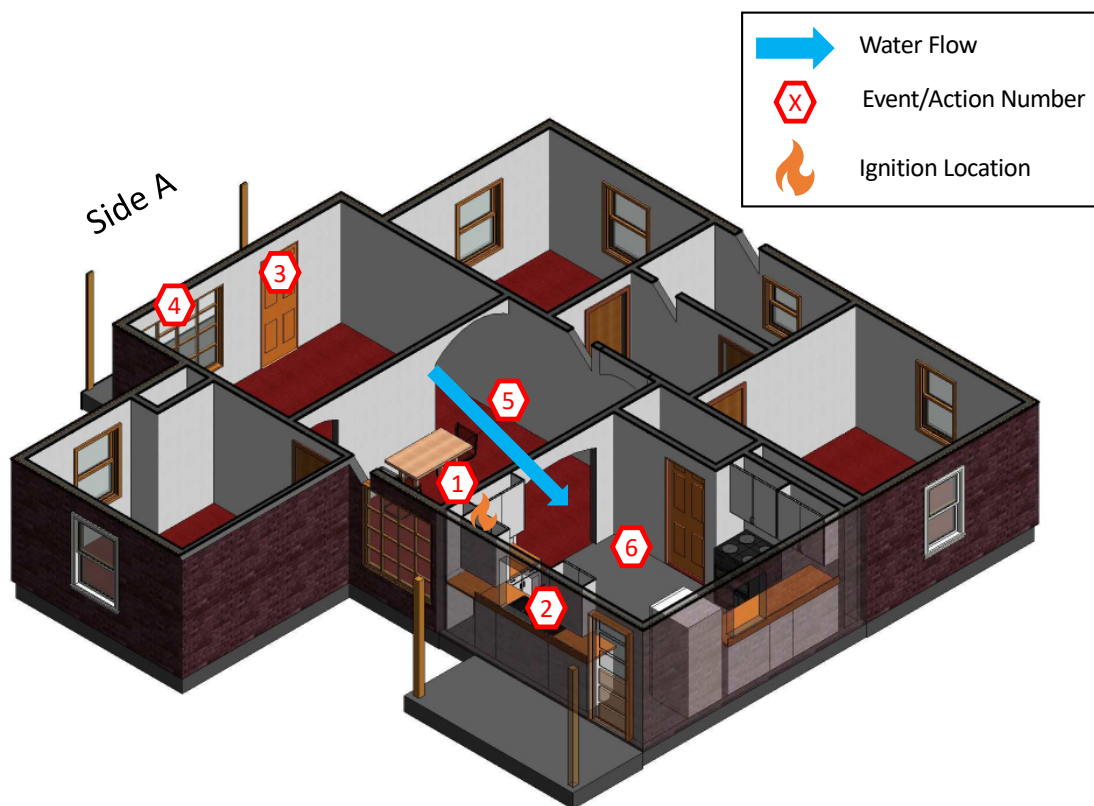

Action/Event	Time (mm:ss)	Time (s)
1 Ignition	00:00	0
2 Flashover	08:52	532
3 Front Door Open	10:00	600
4 Horizontal Ventilation	10:11	611
5 Flow throughout Structure	10:26	626
6 Suppression Crew Entered Fire Room	12:08	728

Figure 3.193: Time and sequence of actions and events for Experiment 16.

Figure 3.194 shows the time history of the temperature variations in the fire room (kitchen). Temperatures nearest the ceiling began to increase approximately 25 s post ignition as products of combustion began to collect near the ceiling. Temperatures below 5 ft began to increase around 100 s post ignition as the smoke layer filled the kitchen. Temperatures at all elevations increased steadily until 30 s prior to flashover. At such time, temperatures increased at a greater rate. Shortly after flames crossed the threshold of both kitchen windows, the fire room transitioned to flashover 532 s post ignition. Flashover is defined here as the point in which temperatures 1 ft above the kitchen floor surpassed 1100 °F. After flashover, temperatures in the kitchen decreased to 1200 °F at the floor and 1400 °F at the ceiling. The conditions within the structure began to change after the ventilation crew opened the front door and completed horizontal ventilation (opened side A win-

dow) approximately 615 s post ignition. Fresh air was entrained through these openings, resulting in increased fire growth; ceiling temperatures were approximately 1700 °F, and floor temperatures were approximately 1600 °F. Water flow decreased temperatures approximately 635 s post ignition.

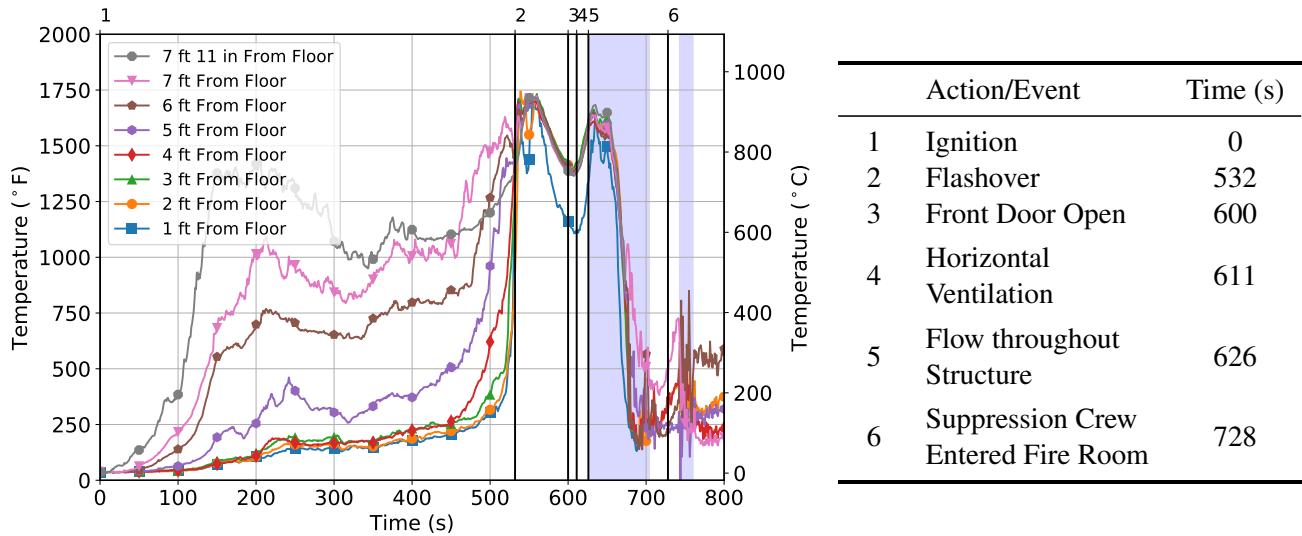
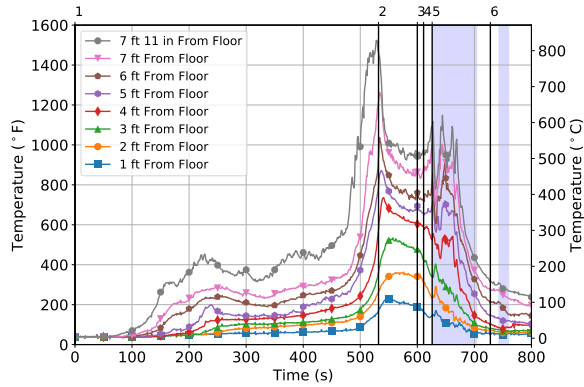

Figure 3.194: Temperatures in fire room (kitchen) for Experiment 16. Blue vertical bars indicate time and duration of water flow.

Temperatures in the remaining open areas of the structure are presented in Figure 3.195. As the fire began to exhaust hot products of combustion into adjacent areas of the structure, temperatures in these areas began to increase relative to their proximity to the kitchen fire. Dining room temperatures increased before living room and bedroom 1 temperatures approximately 100 s, 150 s, and 150 s post ignition, respectively. Temperatures in the structure remote from the fire room increased to local peaks as the upper kitchen cabinets became fully involved in flames 225 s post ignition. Temperatures within all three spaces increased steadily for approximately 400 s as the kitchen fire grew. Approximately 30 s prior to kitchen flashover, temperatures within all three spaces increased at a greater rate. Flashover was not achieved in any of these locations as temperatures at the floor reached 250 °F (dining room), 125 °F, (living room) and 225 °F (bedroom). After kitchen flashover, temperatures in all areas remained stable: The dining room temperatures ranged from 200 °F to 1000 °F, living room temperatures ranged from 150 °F to 450 °F, and bedroom 1 temperatures ranged from 200 °F to 400 °F. Ventilation increased air entrainment to the structure resulting in increased fire growth. Temperatures 4 ft and below in the dining and living rooms decreased after ventilation while temperatures 5 ft and above in the dining and living rooms increased, suggesting air was entrained near the floor and gases were exhausted near the ceiling. Suppression caused a greater reduction in dining room temperatures than in other rooms as the stream from the nozzle was directed into this space.



(a) Dining Room Temperatures

	Action/Event	Time (s)
1	Ignition	0
2	Flashover	532
3	Front Door Open	600
4	Horizontal Ventilation	611
5	Flow throughout Structure	626
6	Suppression Crew Entered Fire Room	728

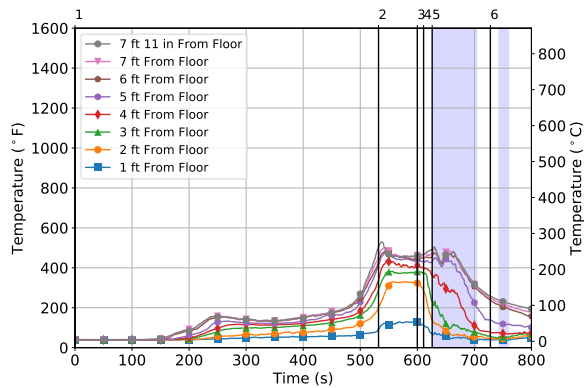

(b) Living Room Temperatures

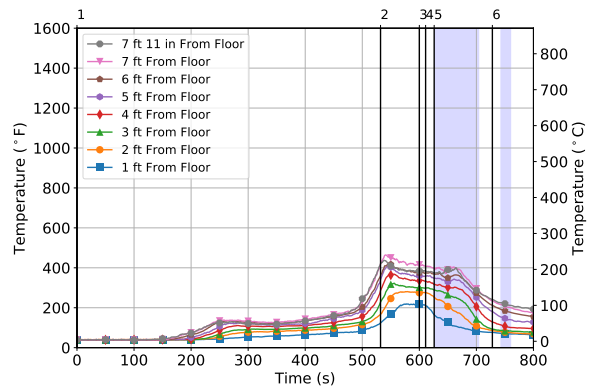

(c) Bedroom 1 Temperatures

Figure 3.195: Temperatures remote from the fire room for Experiment 16. Blue vertical bars indicate time and duration of water flow.

Pressure data collected from the kitchen are presented in Figure 3.196. Kitchen pressure at the 7 ft elevation was effected by the kitchen fire 40 s post ignition. The pressure increased due to expansion of the the hot gases that began to fill the kitchen. Pressure at the 4 ft elevation remained near ambient. Pressure at the 1 ft elevation began to decrease 120 s post ignition. The pressure decreased as the fire grew and entrained air from surrounding areas. Pressures changed at a faster rate during the minute prior to kitchen flashover. Post flashover, the pressure at the 7 ft and 4 ft elevations peaked to 12.6 Pa and 3.1 Pa, respectively. Pressure at all three elevations remained steady during the time between flashover and the front door being opened. The 7 ft elevation was 10.0 Pa, the 4 ft elevation was 1.0 Pa, and the 1 ft elevation was -7.5 Pa. Pressures increased after horizontal ventilation and increased as the water from the hose stream entered the kitchen. Pressures returned to ambient post suppression.

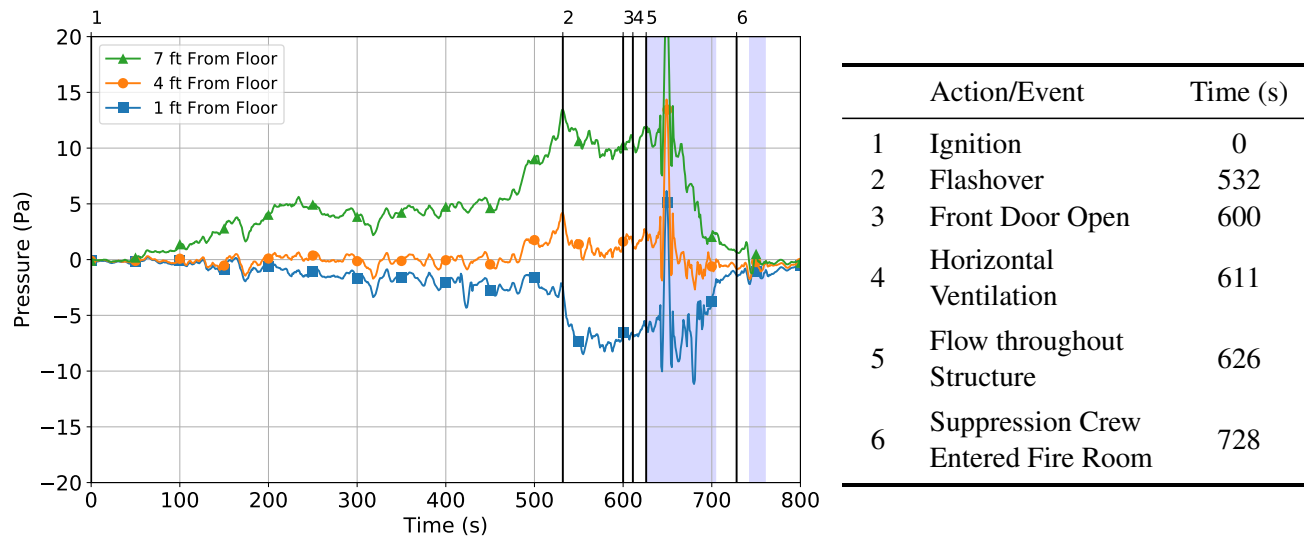
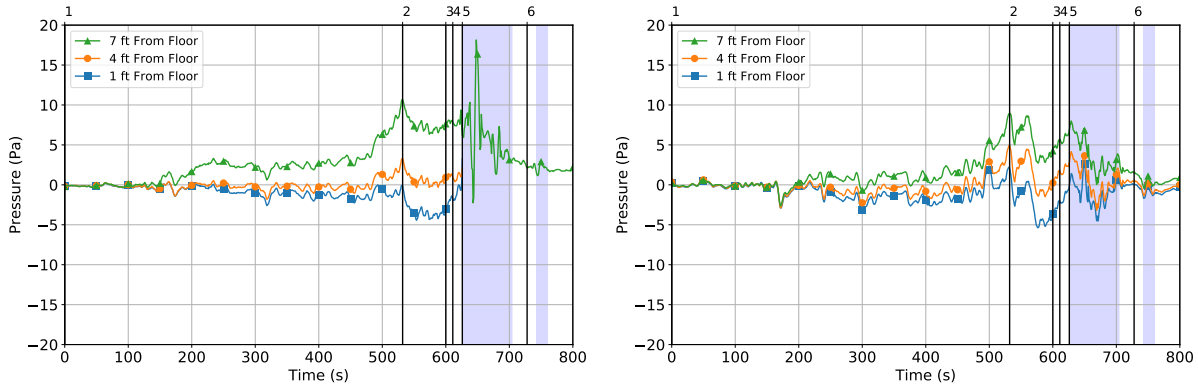

Figure 3.196: Pressures in the fire room (kitchen) for Experiment 16. Blue vertical bars indicate time and duration of water flow.

Pressure data collected in remote areas of the structure are presented in Figure 3.197. Dining room pressures were effected by the kitchen fire before bedroom 1 pressures; the dining room was closer in proximity and more open to the fire room than bedroom 1. The dining room pressure at the 7 ft elevation began to increase around 140 s post ignition. The pressure increased as hot gases exhausted from the kitchen into the dining room. The pressure at the 4 ft elevation remained near ambient. The 1 ft elevation decreased 200 s post ignition. The pressure decreased as air was entrained to the fire room. The pressure differences between elevations suggests the establishment of a bi-directional flow within the space with the neutral plane near the 4 ft elevation. Pressure at all three elevations peaked just prior to or at flashover to 9.7 Pa, 2.3 Pa, and -1.0 Pa, respectively. Pressures became stable until horizontal ventilation caused all pressures to increase. Water flow from the hoseline damaged the 4 ft and 1 ft pressure sensors. The 7 ft elevation returned to ambient conditions post suppression.

Bedroom 1 pressures decreased approximately 160 s post ignition, suggesting air from bedroom 1 was beginning to be entrained to the fire. After the initial negative pressurization of the space, a bi-directional flow was established through the doorway of the bedroom. The pressure at the 7 ft elevation increased 200 s post ignition as higher temperature gases filled the space. The pressure at the 1 ft and 4 ft elevations decreased 225 s post ignition as air within bedroom 1 was entrained to the fire room. All pressures increased during the minute prior to flashover and peaked to 7.8 Pa, 3.8 Pa, and 1.4 Pa, respectively. Pressures increased post-flashover in response to the increased ventilation before decreasing in response to suppression. All pressures returned to ambient conditions post suppression.



(a) Dining Room Pressures

(b) Bedroom 1 Pressures

	Action/Event	Time (s)
1	Ignition	0
2	Flashover	532
3	Front Door Open	600
4	Horizontal Ventilation	611
5	Flow throughout Structure	626
6	Suppression Crew Entered Fire Room	728

Figure 3.197: Pressures remote from fire room for Experiment 16. Flow from the hoseline compromised the pressure at the 1 ft and 4 ft elevations in the dining room. Blue vertical bars indicate time and duration of water flow.

Prior to fire department intervention, the pressure at the 7 ft elevation in the kitchen was greater than the pressure at the 7 ft elevation in the dining room. Similarly, the pressure at the 1 ft elevation in the fire room was less than the pressure at the 1 ft elevation in the dining room. These pressure gradients reflect an exchange of cool air into the fire room through the bottom of the kitchen doorway and hot gases out of the fire room through the top of the doorway. The flow path prior to fire department intervention is illustrated in Figure 3.198a. Opening the front door provided a new air inlet to the structure. Air entrainment from the front door decreased air entrainment from the kitchen windows, resulting in greater exhaust through the windows. The flow path after the front door was opened is presented in Figure 3.198b. Additional ventilation provided from the side A window further increased air entrainment from the front of the structure. The entrainment through the windows decreased further, allowing for more exhaust of products of combustion. The flow path after the ventilation of the side A window is shown in Figure 3.198c.

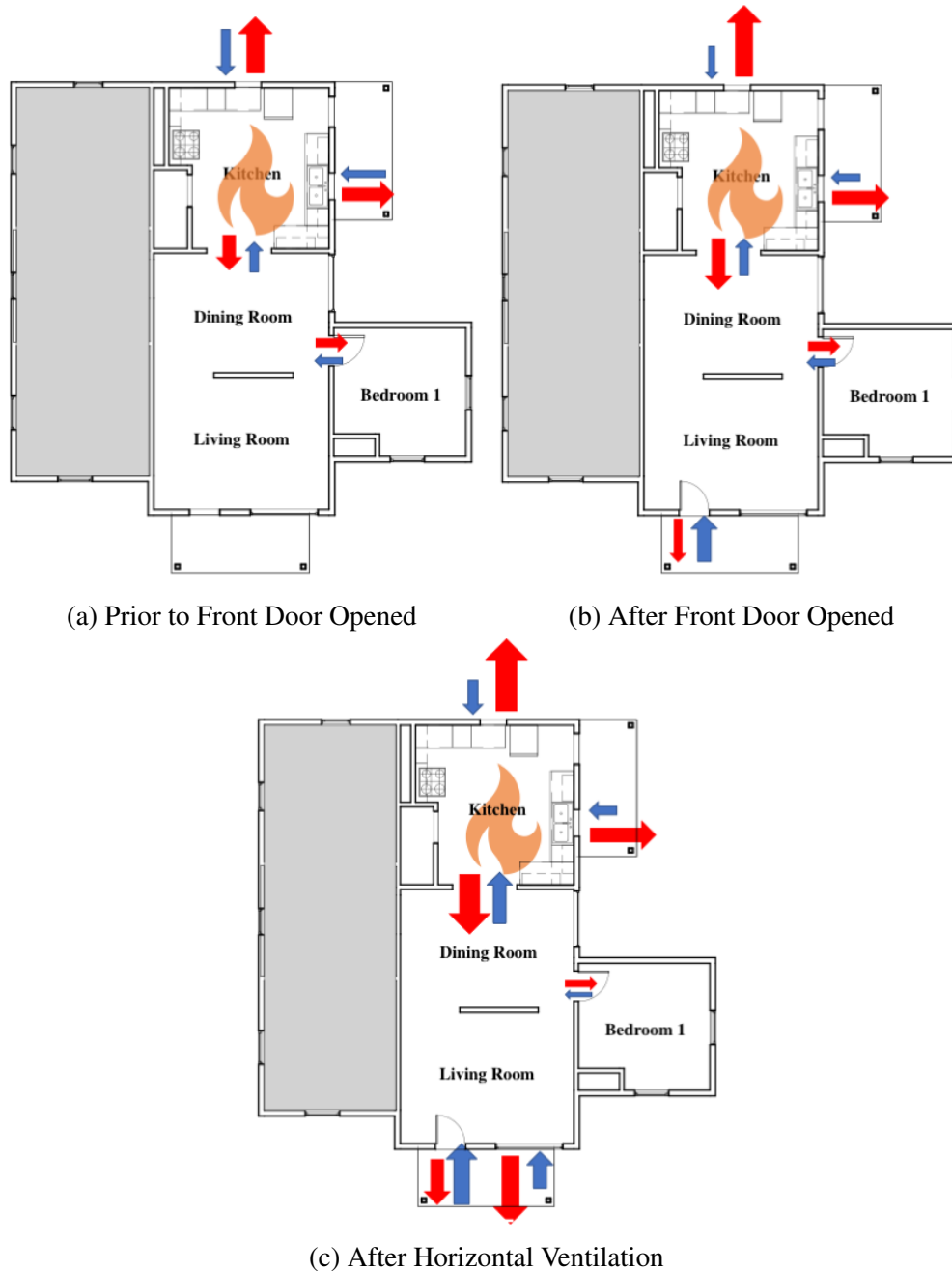
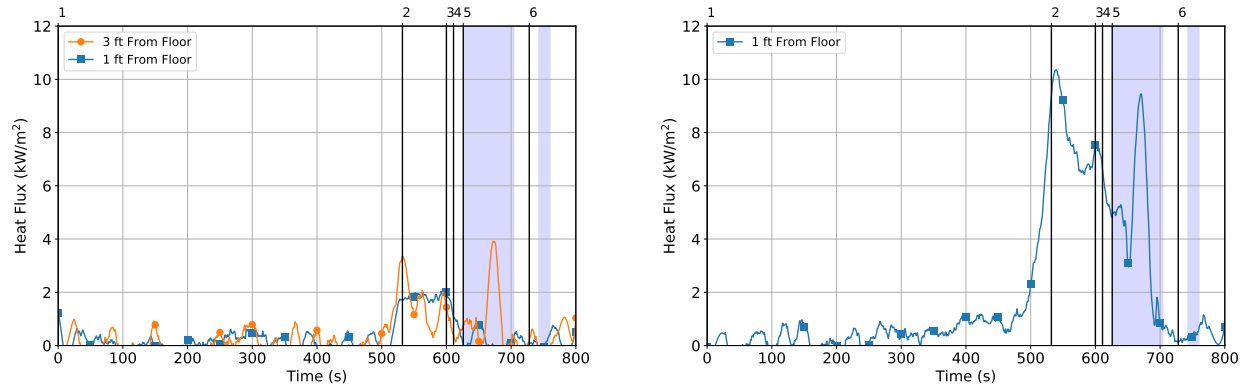

Figure 3.198: Changes in flow path for Experiment 16. Red arrows indicate flow out of the compartment, blue arrows indicate entrainment into the compartment, and the sizes of the arrows indicate the relative magnitude of the flow through each opening.

Heat flux data measured from two locations are presented in Figure 3.199. Dining room heat fluxes measured at 1 ft and 3 ft elevations remained near pre-ignition levels until 30 s prior to flashover when both increased. During flashover, the heat flux at the 3 ft elevation peaked to 3.5 kW/m^2 , while the heat flux at the 1 ft elevation peaked to approximately 2.0 kW/m^2 . Post-flashover conditions caused the heat flux at the 3 ft elevation to decrease and the heat flux at the

1 ft elevation to remain steady. Ventilation of the front door and window increased air entrainment into the structure, resulting in decreased heat flux at both elevations.

Bedroom 1 heat flux measured 1 ft above the floor remained near pre-ignition levels until 30 s prior to flashover, when heat flux increased. Approximately 10 s post flashover, the dining room heat flux peaked to approximately 10.5 kW/m². Post-flashover conditions reduced the heat flux below 7.0 kW/m². Ventilation of the front door and window further decreased the heat flux to approximately 5.0 kW/m². Heat fluxes, post suppression, returned to ambient conditions.



(a) Dining Room Heat Fluxes

(b) Bedroom 1 Heat Flux

	Action/Event	Time (s)
1	Ignition	0
2	Flashover	532
3	Front Door Open	600
4	Horizontal Ventilation	611
5	Flow throughout Structure	626
6	Suppression Crew Entered Fire Room	728

Figure 3.199: Heat flux in the remote rooms for Experiment 16. Blue vertical bars indicate time and duration of water flow.

CO, CO₂, and O₂ concentrations were measured at two elevations in the dining room; the data collected is presented in Figure 3.200. Gas concentrations at the 3 ft elevation gradually began to change 250 s post ignition, while the 1 ft elevation gradually began to change 280 s post ignition. A simultaneous decrease in O₂ concentration occurred as CO and CO₂ concentrations increased for both elevations. Gas concentrations increased more rapidly during post-flashover conditions. Gas concentrations at the 3 ft elevation peaked after ventilation was complete: CO was 0.7%, CO₂ was 4.6%, and O₂ was 16.8%. Gas concentrations at the 1 ft elevation increased gradually after ventilation occurred. Gas concentrations at both elevations returned to pre-ignition conditions after suppression.

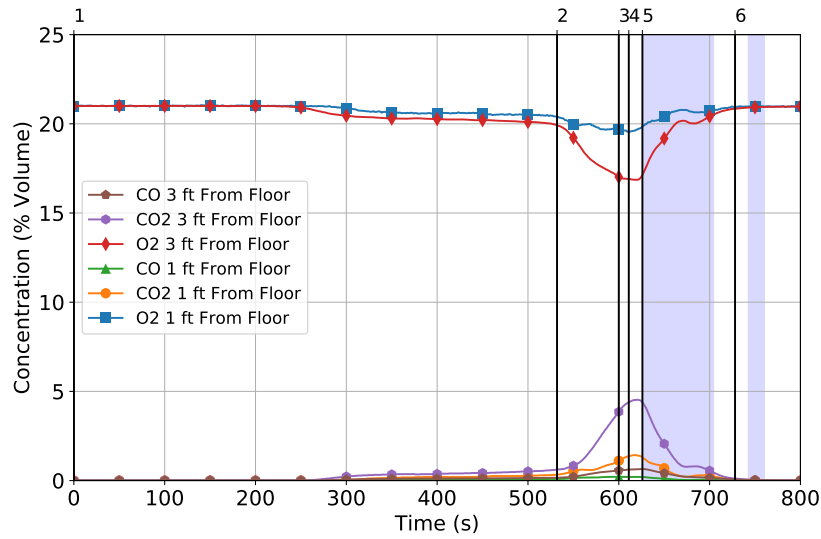

	Action/Event	Time (s)
1	Ignition	0
2	Flashover	532
3	Front Door Open	600
4	Horizontal Ventilation	611
5	Flow throughout Structure	626
6	Suppression Crew Entered Fire Room	728

Figure 3.200: Dining room gas concentrations in Experiment 16. Blue vertical bars indicate time and duration of water flow.

3.17 Experiment 17 — Interior Suppression with Coordinated Positive Pressure Ventilation

Experiment 17 was conducted to evaluate the effect of positive pressure ventilation coordinated with interior suppression (positive pressure attack) on a first-floor kitchen fire. Positive pressure ventilation (PPV) was established by placing a fan at the front door. A two-story, single-family home located at 230 North Walnut Street in Sidney, Ohio, was instrumented to conduct this first-floor kitchen fire experiment. Exterior photos of this wood-framed structure appear in Figure 3.187. The structure was stick-built with rough cut lumber framing and finished with a combination of wood and vinyl siding and brick. The foundation was a combination of brick and concrete block. The peaked roof was constructed using 1 in.-by-6 in. sheathing covered with asphalt shingles. Interior walls and ceilings were constructed with plaster and lath, while the entryway walls were finished with wood paneling. The ceilings on the first-floor were 10 ft in height. Interior floors were finished with vinyl tile in the kitchen, carpet in the bedrooms, and wood in all other areas. Detailed dimensioned drawings for the structure appear in Appendix Figures B.3 and B.4.



(a) Side A



(b) B/C Corner



(c) Side C



(d) Side D

Figure 3.201: Exterior photographs of the structure for Experiment 17.

This structure had two levels and a partial basement. The first-floor had a living room, family room, dining room, and kitchen. The second-floor contained three bedrooms. The A/B corner stairwell connected the two floors. These areas defined the experimental volume of the structure. A second-floor bedroom, bathroom, and rear stairwell were separated from the experimental volume to protect sensitive instrumentation. This experiment utilized the first-floor kitchen as the fire room. The structure was instrumented for temperature, pressure, heat flux, IR, and standard video to capture the fire dynamics during experimentation. Instrumentation was also installed to characterize the potential for skin burns and occupant toxic exposure during the experiment. Figure 3.202 shows the layout of the structure with the instrumentation locations.

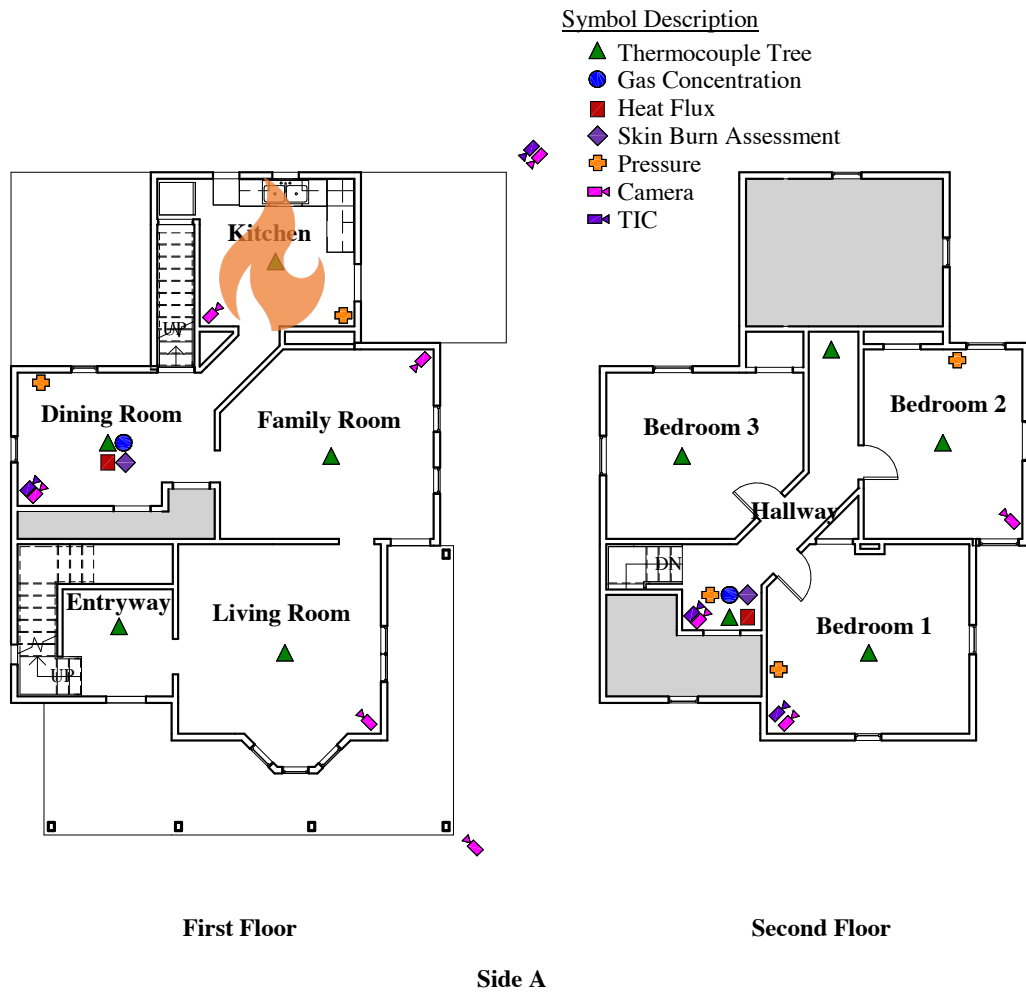

Figure 3.202: Instrumentation and floor plan for Experiment 17. Gray areas were isolated from the remainder of the structure and utilized as instrumentation space.

The fire room (kitchen) was furnished with the kitchen fuel package described in Section 2.4.2 and contained a range, refrigerator, table, and two chairs. The ignition location in the C/D corner of the room was surrounded by a large bag of potato chips, a coffee maker, and two paper towel rolls.

The cabinets directly above the ignition location were filled with approximately 1250 paper cups and the doors were left partially open. The kitchen pantry located along side A contained 17 paper towel rolls, while five paper towel rolls were located on top of the refrigerator. The kitchen windows located on side C were removed to provide comparable ventilation to other experiments that was sufficient to support flashover. The kitchen door on side D remained closed for the duration of the experiment. Photographs of the fire room prior to ignition are presented in Figure 3.203. A dimensioned layout of the kitchen is included in Figure 3.204. A detailed drawing of the kitchen cabinets is included in Figure 3.205.



(a) A/B Corner

(b) Side C



(c) Side D

Figure 3.203: Interior photographs of fire room (kitchen) for Experiment 17.

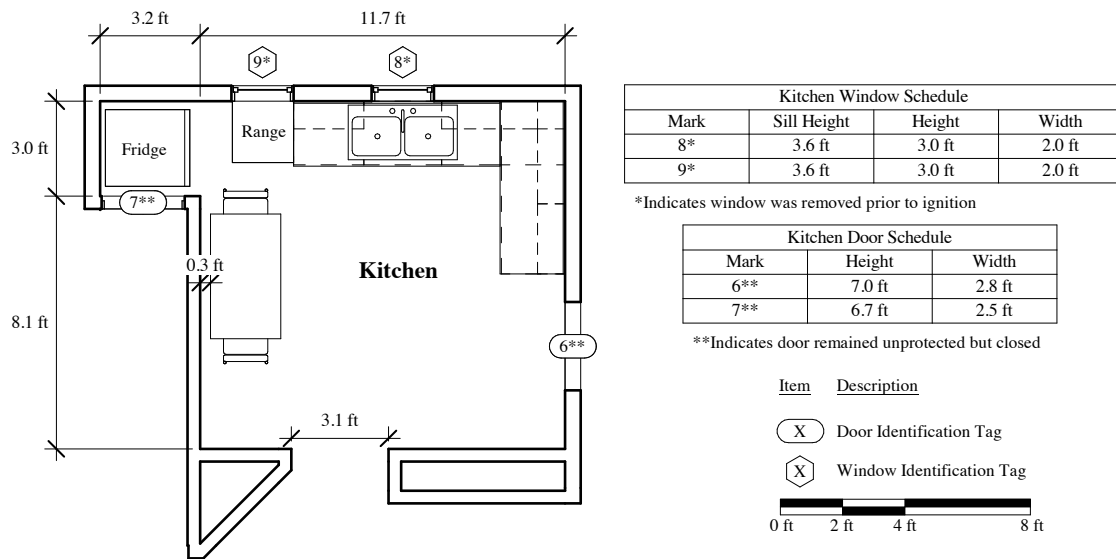

Figure 3.204: Fire room layout for Experiment 17.

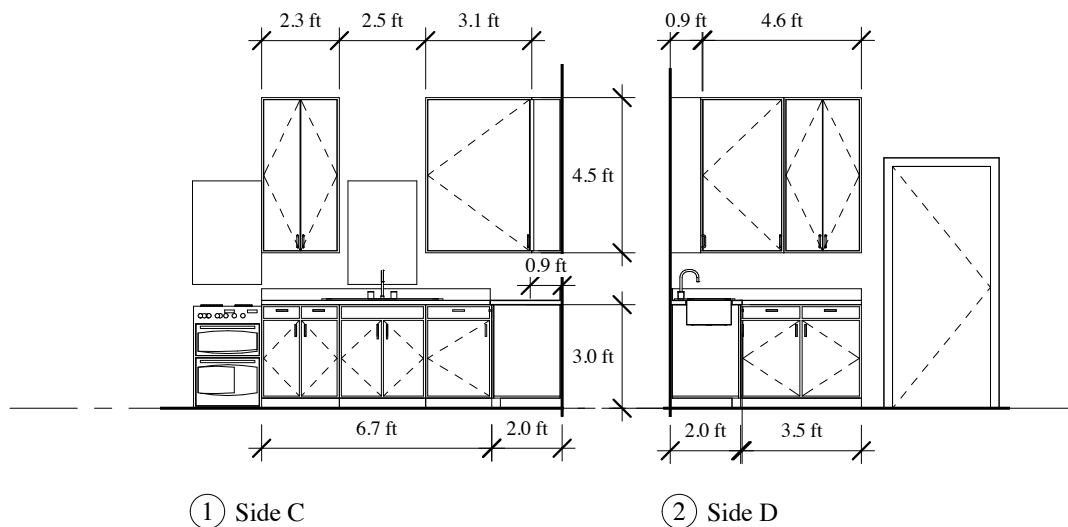
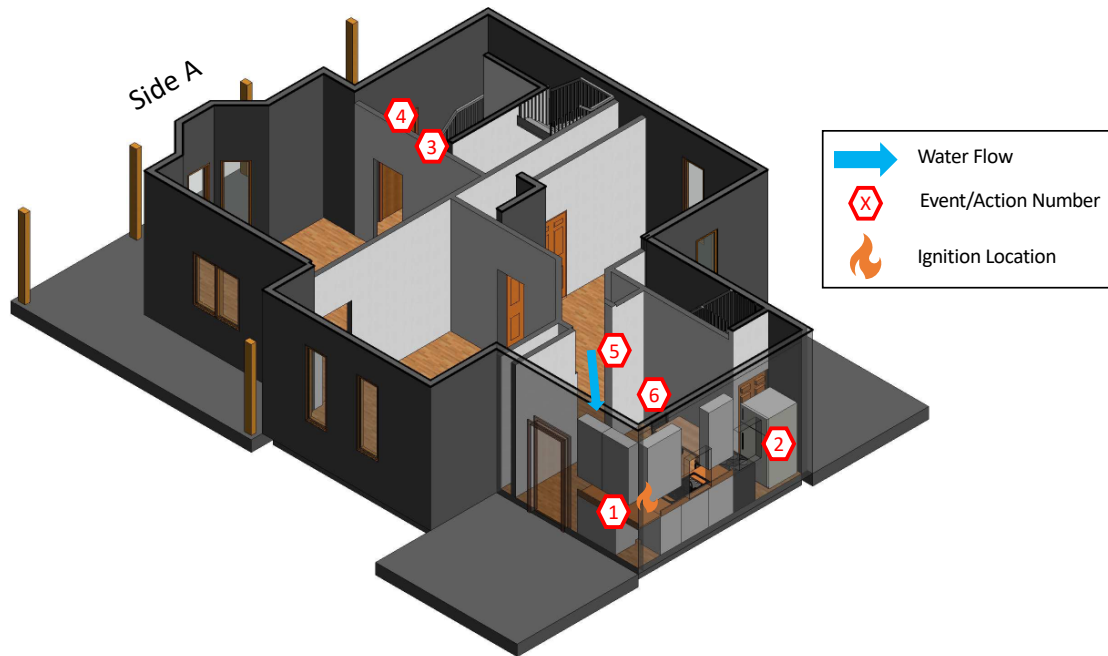

Figure 3.205: Wall and base cabinet locations, dimensions, and elevations within the kitchen for Experiment 17.

The ignition package located on top of the C/D corner counter was ignited ($t = 0$ s). Flames were visible from the kitchen window (labeled 8 in Figure 3.204) 436 s (7:16) post ignition. Flashover occurred at 650 s (10:50) post ignition. The fire transitioned to a post flashover state with fire continuously venting from window 8 before any fire department intervention occurred.

The front door was opened 781 s (13:01) post ignition. The PPV fan⁴ was turned on prior to the front door opening and was positioned to face the front door 791 s (13:11) post ignition. The suppression crew entered the structure through the front door advancing a 1.75 in. hoseline with a combination nozzle set to straight stream. The crew advanced to the dining room, where they stopped to flow water into the kitchen 851 s (14:11) post ignition for 9 s. The stream was directed toward the side B wall of the hallway leading into the kitchen. The suppression crew then moved closer to the kitchen, entering the fire room, before flowing water 869 s (14:29) post ignition for 10 s. While within the fire room, the suppression crew opened the hoseline three additional times at 889 s (14:49), 901 s (15:01), and 918 s (15:18) post ignition. The duration of each water flow was 7 s, 10 s, and 4 s respectively. After the fifth water application, the suppression crew stopped flowing water. The total tactic time, from front door open to entrance to the fire room, lasted 88 s (1:28). The total water flowed for initial suppression was 99 gal, which did not include the water flowed during mop-up operations. Figure 3.206 shows the sequence of events with an isometric image of the structure.

⁴An gas PPV fan with a 14,155 CFM capacity was placed roughly 5 ft from the front door at an approximate angle of 95°. Firefighters ensured flow through the top of the doorway and placed the fan on full throttle.



Action/Event	Time (mm:ss)	Time (s)
1 Ignition	00:00	0
2 Flashover	10:50	650
3 Front Door Open	13:01	781
4 PPV Fan Turned In	13:11	791
5 Flow from Dining Room	14:11	851
6 Suppression Crew Entered Fire Room	14:29	869

Figure 3.206: Time and sequence of actions and events for Experiment 17.

The time history of temperatures recorded in the fire room are shown in Figure 3.207. Temperatures 8 ft above the floor and higher began to increase approximately 50 s post ignition. These temperatures peaked between 675 °F and 1100 °F 340 s post ignition, corresponding to the cabinet door falling into the floor near the thermocouple array. Temperatures at all elevations began increasing more rapidly within the minute prior to flashover, during which the paper towel roll located on the kitchen table became engulfed in flames 588 s post ignition. Flashover occurred when floor temperatures exceeded 1100 °F 650 s post ignition. Temperatures during post-flashover conditions remained stable between 1600 °F at the ceiling and 600 °F at the floor until the front door was opened 781 s post ignition (Action 3). After which, temperatures briefly decreased before increasing back to their post-flashover state. Upon application of water 851 s post ignition, temperatures within the kitchen decreased to pre-combustion conditions.

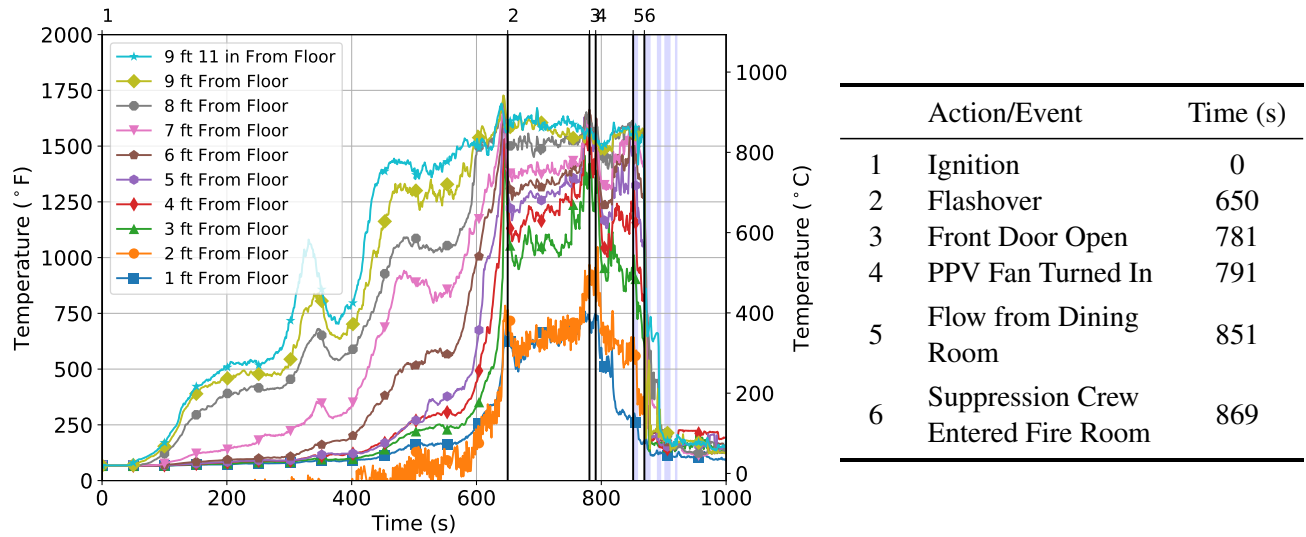
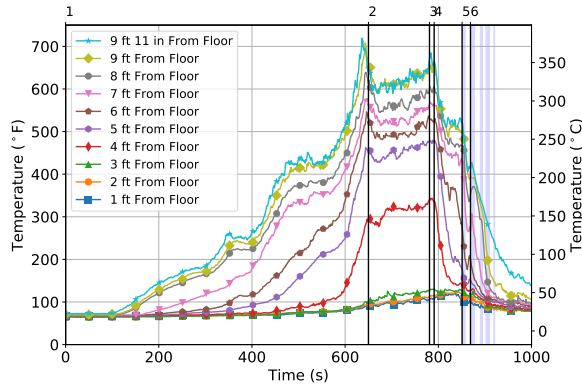

Figure 3.207: Temperatures in fire room (kitchen) for Experiment 17. The thermocouple 2 ft in elevation was compromised by from the water stream. Blue vertical bars indicate time and duration of water flow.

Temperatures recorded at first-floor locations remote from the kitchen are presented in Figure 3.208. Temperatures increased based on their relative proximity to the fire room as products of combustion spread throughout the structure. Dining room temperatures (see Figure 3.208a) increased around 100 s post ignition. Temperatures in the family room (see Figure 3.208b) began to increase around 250 s post ignition. Living room temperatures (see Figure 3.208c) began to increase around 400 s post ignition. Temperatures 4 ft above the floor and higher throughout the remote areas of the first floor peaked during kitchen flashover 650 s post ignition with peak dining room temperatures of 720 °F, family room temperatures of 440 °F, and living room temperatures of 220 °F. Before 3 ft, temperatures remained below 125 °F. This stratification of temperatures indicates the smoke layer did not descend past 3 ft. Post-flashover conditions produced steady temperatures for the smoke layer between 130°F and 620 °F throughout the structure. Temperatures began to decrease after the PPV fan was turned to face the doorway. Temperatures returned to pre-ignition conditions after suppression was complete.



(a) Dining Room Temperatures

	Action/Event	Time (s)
1	Ignition	0
2	Flashover	650
3	Front Door Open	781
4	PPV Fan Turned In	791
5	Flow from Dining Room	851
6	Suppression Crew Entered Fire Room	869

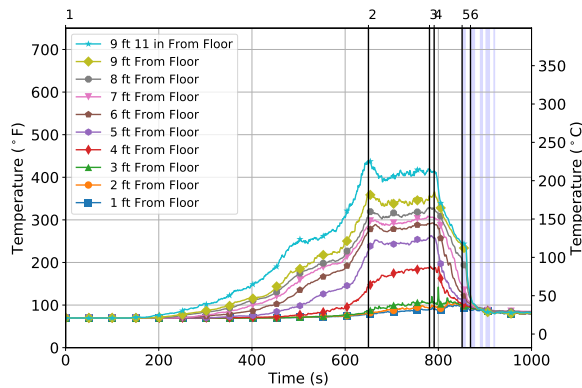

(b) Family Room Temperatures

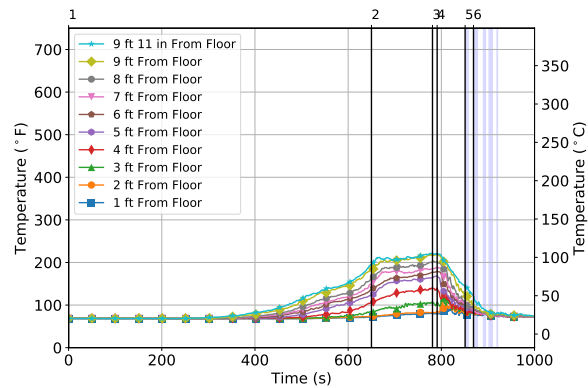

(c) Living Room Temperatures

Figure 3.208: Temperatures remote from the fire room located on the first-floor for Experiment 17. Blue vertical bars indicate time and duration of water flow.

Temperatures recorded on the second-floor are presented in Figure 3.209. Bedroom 1 (see Figure 3.209a) and bedroom 2 (see Figure 3.209b) temperature behaved similarly, increasing just prior to flashover (approximately 650 s post ignition) and reaching a local maximum just after positive pressure ventilation was established. Bedroom 3 (see Figure 3.209c) ceiling temperatures began increasing earlier than the other bedrooms, at approximately 170 s post ignition. Temperatures similarly reached a local maximum just after positive pressure ventilation. Temperatures in all three bedrooms reached a peak of approximately 110 °F. Temperatures steadily decreased after positive pressure ventilation began and continued through suppression, after which temperatures returned to near pre-ignition conditions. Hallway temperatures began increasing most significantly within the minute prior to flashover. Temperatures in the hallway between bedrooms 1 and 3 (see Figure 3.209e) began increasing before temperatures in the hallway between bedrooms 2 and 3 due to the closer proximity to the stairwell. Temperatures within the hallway peaked just after positive pressure ventilation was established reaching peaks of approximately 115 °F. Temperatures decreased after PPV and continued to pre-ignition conditions with suppression of the kitchen fire.

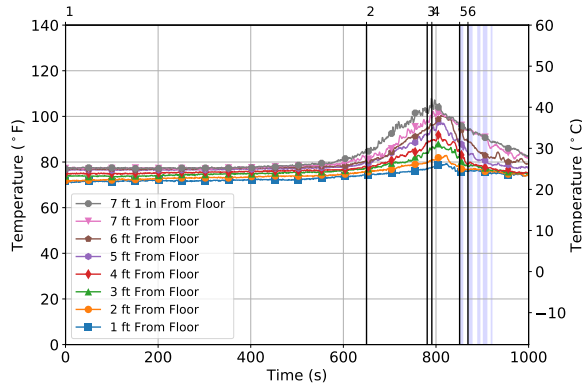

(a) Bedroom 1 Temperatures

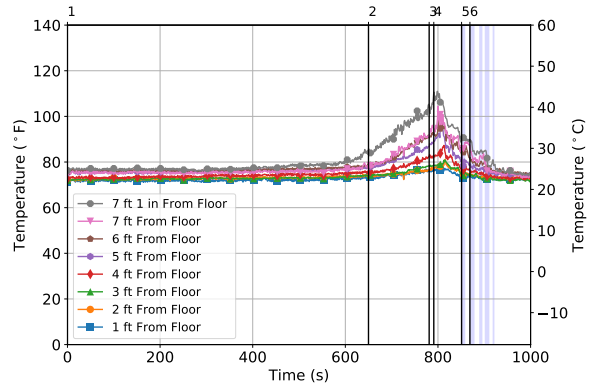

(b) Bedroom 2 Temperatures

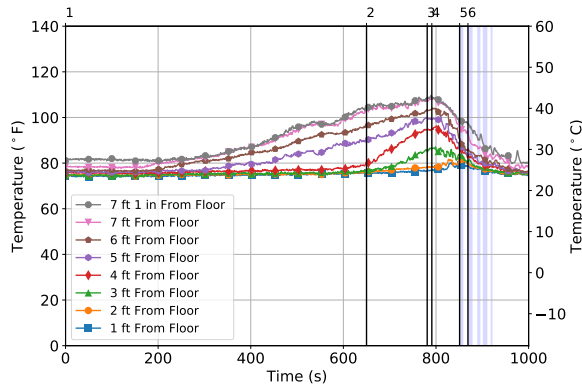

(c) Bedroom 3 Temperatures

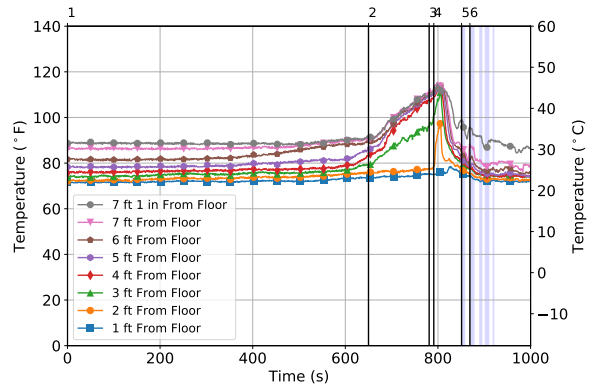

(d) Hallway Temperatures near Bedroom 1

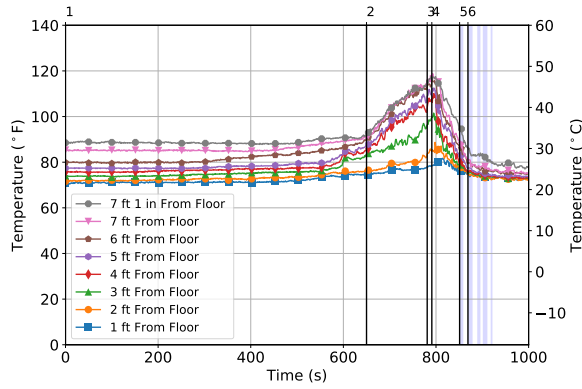

(e) Hallway Temperatures between Bedrooms 2 - 3

	Action/Event	Time (s)
1	Ignition	0
2	Flashover	650
3	Front Door Open	781
4	PPV Fan Turned In	791
5	Flow from Dining Room	851
6	Suppression Crew Entered Fire Room	869

Figure 3.209: Temperatures remote from the fire room located on the second-floor for Experiment 17. Blue vertical bars indicate time and duration of water flow.

The pressure data collected from the fire room is presented in Figure 3.210. Due to the height of the ceiling, pressure at the 7 ft elevation increased 200 s post ignition as the hot gas layer was established and began to bank down. Pressures at the 4 ft and 1 ft elevation initially decreased 200 s post ignition as air was entrained into the fire room. Pressure at the 1 ft elevation began to decrease more rapidly than the 4 ft elevation around 400 s post ignition as flames spread along

the ceiling began. At flashover, pressure at the 7 ft elevation peaked to 8.4 Pa, while the 1 ft elevation decreased to -9.8 Pa. The pressure at the 4 ft elevation returned to atmospheric conditions, indicating the presence of a neutral plane. Post-flashover, pressures at each elevation remained steady near their flashover magnitude. Pressure at all elevations increased approximately 3.0 Pa to 5.0 Pa after the PPV fan was turned to face the doorway, indicating the fan was positively pressurizing the space as desired. Pressures at all elevations returned to atmospheric pressure during suppression.

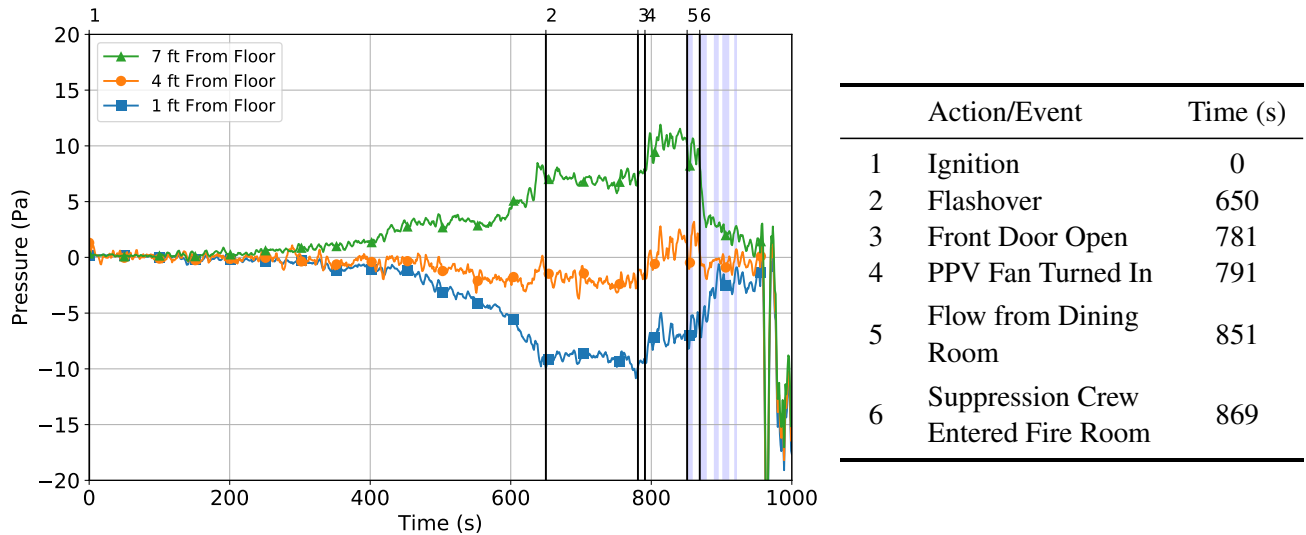
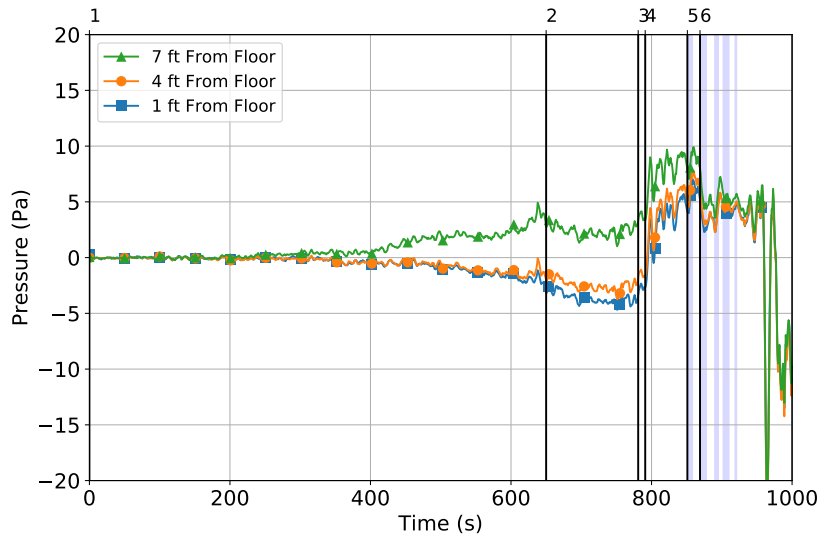

Figure 3.210: Pressures in the fire room (kitchen) for Experiment 17. Blue vertical bars indicate time and duration of water flow.

Dining room pressures (see Figure 3.211) responded to the bi-directional flow created by the kitchen fire 250 s post ignition. Pressure at the 7 ft elevation increased to approximately 5.0 Pa while the 4 ft and 1 ft elevations to decreased to approximately -3.0 and -4.0 Pa, respectively. These pressures remained stable until the PPV fan was turned to face the doorway 791 s post ignition. Pressures increased between 6.0 Pa and 8.0 Pa, and remained at an elevated state until the fan was turned off.



	Action/Event	Time (s)
1	Ignition	0
2	Flashover	650
3	Front Door Open	781
4	PPV Fan Turned In	791
5	Flow from Dining Room	851
6	Suppression Crew Entered Fire Room	869

Figure 3.211: Dining room pressures for Experiment 17. Blue vertical bars indicate time and duration of water flow.

Pressure on the second-floor (i.e., pressures within bedroom 1 (see Figure 3.212a), bedroom 2 (see Figure 3.212b), and the hallway (see Figure 3.211)) were not impacted by the fire growth of the first-floor kitchen fire. Pressures at all elevations remained at pre-ignition values until the front door was opened upon which pressure increased by approximately 1.0 Pa. Following the start of PPV, pressures increased by approximately 8.0 Pa. Pressures remained at an elevated state until the fan was turned off. Bedroom 3 pressure did not record during Experiment 17, as the sensor was damaged in Experiment 12.

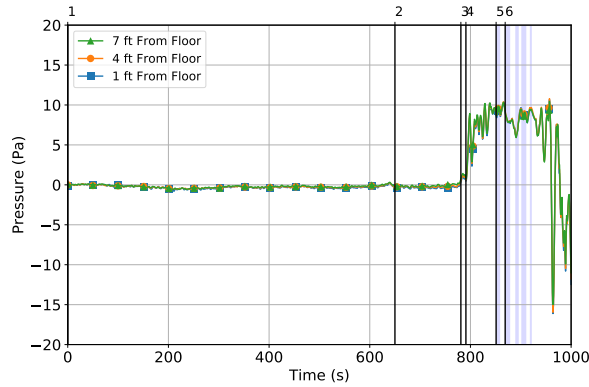

(a) Bedroom 1 Pressures

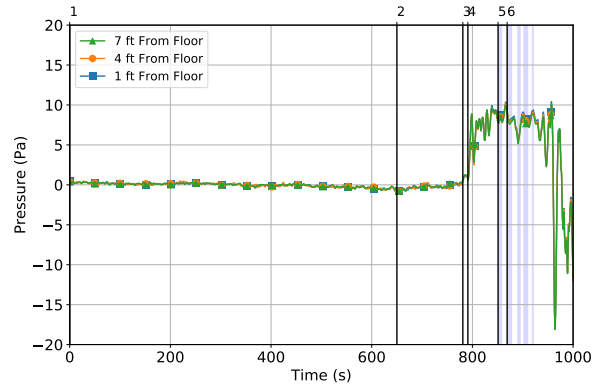

(b) Bedroom 2 Pressures

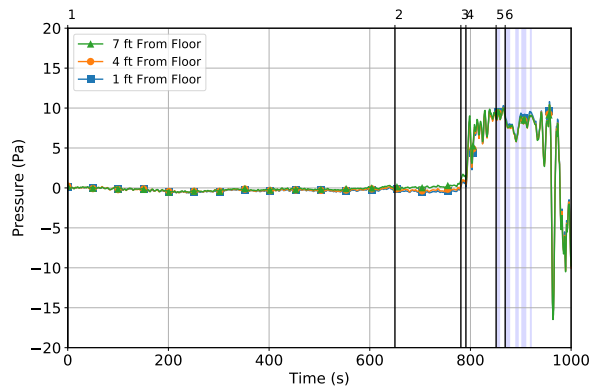

(c) Hallway Pressures

	Action/Event	Time (s)
1	Ignition	0
2	Flashover	650
3	Front Door Open	781
4	PPV Fan Turned In	791
5	Flow from Dining Room	851
6	Suppression Crew Entered Fire Room	869

Figure 3.212: Pressures remote on the second-floor for Experiment 17. Blue vertical bars indicate time and duration of water flow.

The fire growth in the kitchen created bi-directional flows throughout openings within the structure. Differences in pressure between the fire room and remote locations illustrate the changes in flow before and post fire department interventions. Prior to fire department interventions the only exterior ventilation openings were the two kitchen windows on side C. Pressure at the 7 ft elevation in the fire room was greater than the pressure at the same height in the dining room or on the second-floor. Similarly, pressure at the 1 ft elevation in the fire room was less than the pressure at the same elevation elsewhere in the structure. The gradient in pressure confirms the entrainment of air into the fire room near the floor and the exhaust of hot gases out of the fire room near the ceiling. The flows prior to fire department intervention is illustrated in Figure 3.213a.

The front door was opened 781 s post ignition, establishing a third ventilation hole. As fresh air was entrained through the bottom of the front door, less air was entrained through the kitchen windows. As less air was entrained through the bottom of the windows, more gases were exhausted through the top of the windows as well as through the top of the front door. Figure 3.213b represents the flow paths within the structure after the front door was opened.

The PPV fan was turned into the front door approximately 10 s after the front door was opened.

By positively pressurizing the structure from the front door, the doorway became an inlet for fresh air. The kitchen windows became the exhaust for hot gases. Figure 3.213c represents the flow path within the structure after the PPV fan was turned into the front door.

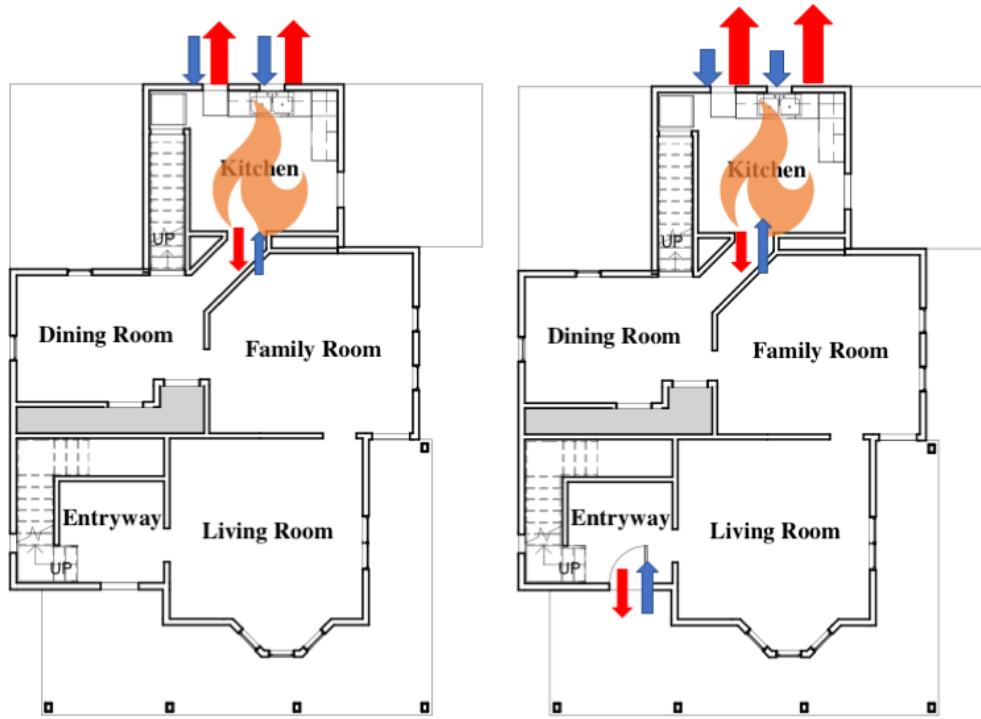

(a) Prior to Front Door Opened

(b) After Front Door Opened

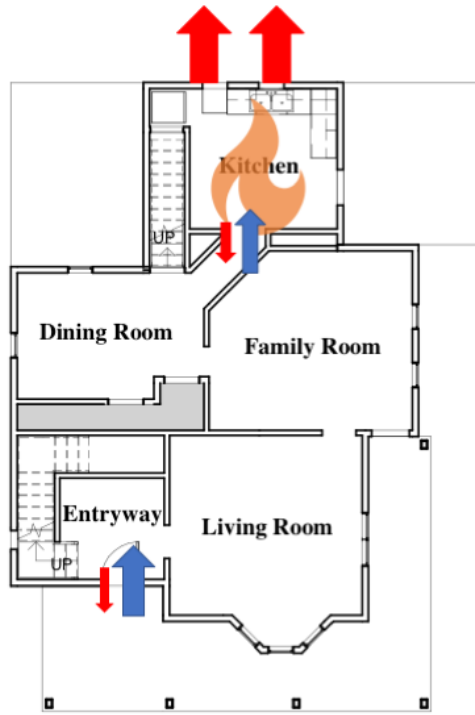

(c) During PPV

Figure 3.213: Changes in flow path for Experiment 17. Red arrows indicate flow out of the compartment, blue arrows indicate entrainment into the compartment, and the sizes of the arrows indicate the relative magnitude of the flow through each opening.

Heat flux data recorded in the dining room and hallway are presented in Figure 3.214. Dining room heat flux at the 1 ft elevation began to increase approximately 400 s post ignition. Heat flux peaked around the time of flashover to 1.7 kW/m^2 . Post-flashover conditions produced a steady heat flux that remained around 2.0 kW/m^2 . Following positively pressurizing the structure, the heat flux decreased to 0.7 kW/m^2 as cool air was entrained through the dining room into the kitchen. The heat flux increased just before suppression efforts began to 1.8 kW/m^2 , but returned to pre-ignition conditions after suppression was complete.

Hallway heat flux at both the 1 ft and 3 ft elevations did not increase above 1.3 kW/m^2 for the duration of the experiment.

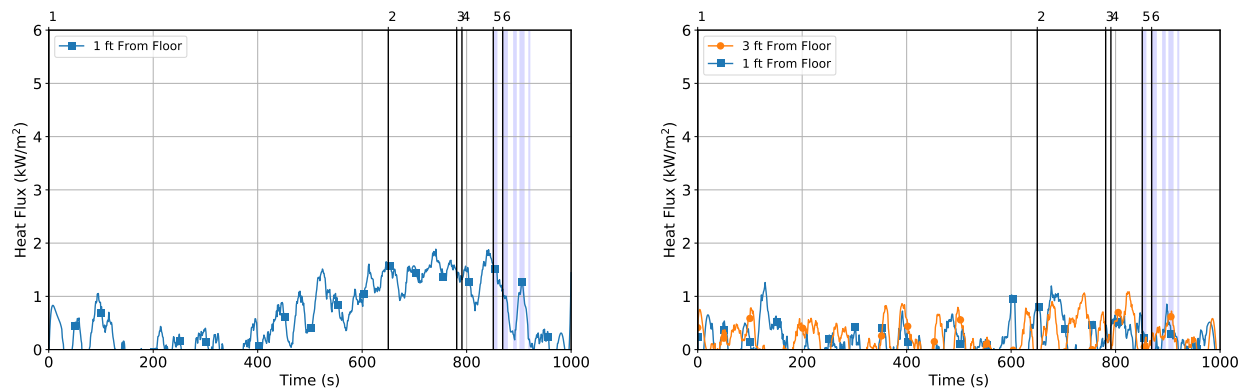

(a) Dining Room Heat Flux

(b) Hallway Heat Fluxes

	Action/Event	Time (s)
1	Ignition	0
2	Flashover	650
3	Front Door Open	781
4	PPV Fan Turned In	791
5	Flow from Dining Room	851
6	Suppression Crew Entered Fire Room	869

Figure 3.214: Heat flux in remote locations for Experiment 17. Blue vertical bars indicate time and duration of water flow.

The aforementioned locations also measured gas concentrations, and the CO , CO_2 , and O_2 data recorded is presented in Figure 3.215. Dining room gas concentrations (see Figure 3.215a) began to change around 500 s post ignition. O_2 concentration during flashover was 19.8%. O_2 concentration continued to decrease throughout the experiment until it reached a minimum 845 s post ignition of 16.5%. CO and CO_2 concentrations during flashover were 0.2% and 0.4%, respectively. Similarly, concentrations increased until reaching a maximum of 0.7% and 3.6% approximately 1 min. after the PPV fan was turned into position.

Hallway gas concentrations (see Figure 3.215b) at the 3 ft elevation began to change around 600 s post ignition, while the 1 ft elevation began to change around 660 s post ignition. Conditions at

the 3 ft elevation were worse than at the 1 ft elevation for the entirety of the experiment. Hallway gas concentrations reached peak concentrations of O₂ at 17.2%, CO at 0.7%, and CO₂ at 2.3%, approximately 10 s after the PPV fan was turned into position. Mechanical ventilation of the structure combined with suppression returned the hallway gas concentration to ambient levels.

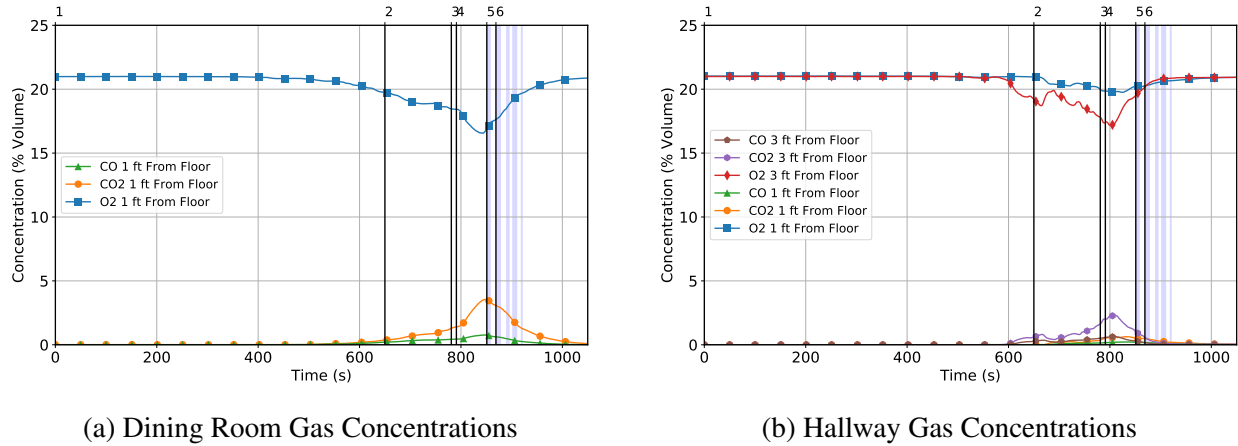

	Action/Event	Time (s)
1	Ignition	0
2	Flashover	650
3	Front Door Open	781
4	PPV Fan Turned In	791
5	Flow from Dining Room	851
6	Suppression Crew Entered Fire Room	869

Figure 3.215: Gas concentrations at remote locations in Experiment 17. Blue vertical bars indicate time and duration of water flow.

Kitchen Fires Method 6

3.18 Experiment 18 — Exterior Fire Control without Additional Ventilation

Experiment 18 was designed to examine exterior water flow followed by interior water flow with no additional ventilation. A two-story, single-family home located at 1030 Hilltop Road in Xenia, Ohio, was instrumented to conduct this first-floor kitchen fire experiment. Exterior photos of this wood-framed structure appear in Figure 3.216. The structure was stick-built with rough cut lumber framing with wood-slat siding. The foundation was a combination of block and stone. The original house had a hip-style tin roof supported by wood members and the rear addition had a peaked roof constructed using 1 in.-by-6 in. sheathing covered with asphalt shingles. Interior walls were finished with plasterboard and lath while floors were finished with vinyl tile in the kitchen, wood in the dining room, and carpet throughout all remaining areas. Detailed dimensioned drawings for each floor of the structure appear in Appendix Figures B.12 and B.13.



(a) Side A



(b) Side B



(c) Side C



(d) Side D

Figure 3.216: Exterior photographs of the structure for Experiment 18.

The structure had two floors and a partial basement. A one-and-a-half-story addition was built, increasing the total area of the structure to 2,912 sq ft. The first-floor had a flex space, living room, dining room, and kitchen. The second-floor had three bedrooms and a second flex space. The side A stairwell connected the two floors. These areas defined the experimental volume of the structure. Various spaces on the first and second-floors were separated from this volume and used as instrumentation space. This experiment utilized the first-floor kitchen as the fire room. The structure was instrumented for temperature, pressure, heat flux, IR, and standard video to capture the fire dynamics during experimentation. Instrumentation was also installed to characterize the potential for skin burns and occupant toxic exposure during the experiment. Figure 3.217 shows the layout of the structure with the instrumentation locations.



Figure 3.217: Instrumentation and floor plan for Experiment 18. The gray areas were isolated from the remainder of the structure and utilized as space for instrumentation.

The fire room (kitchen) was furnished with the kitchen fuel package described in Section 2.4.2 and contained a range, refrigerator, table, and two chairs. The ignition location was immediately surrounded by nine small bags of potato chips and eight paper towel rolls. The wall cabinets directly above the ignition location were left open, exposing approximately 1250 paper cups and two paper towel rolls. Fourteen paper towel rolls were placed on top of the wall cabinets in the B/C corner while six paper towel rolls were located on top of the refrigerator. The kitchen windows on side D were removed prior to ignition to ensure repeatable fire growth and a sufficient oxygen supply for flashover. The side D door remained closed for the duration of the experiment. Photographs of the fire room prior to ignition are presented in Figure 3.218. A dimensioned layout of the kitchen is included in Figure 3.219. A detailed drawing of the kitchen cabinets is included in Figure 3.220.



(a) Side A

(b) Side C



(c) C/D Corner

Figure 3.218: Interior photographs of fire room for Experiment 18.

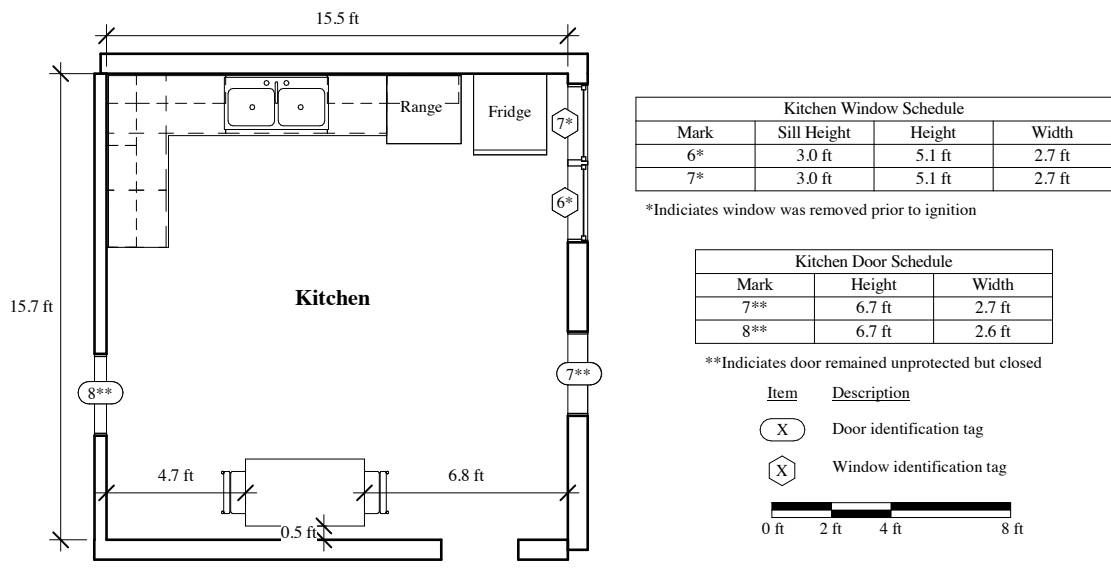

Figure 3.219: Fire room layout for Experiment 18.

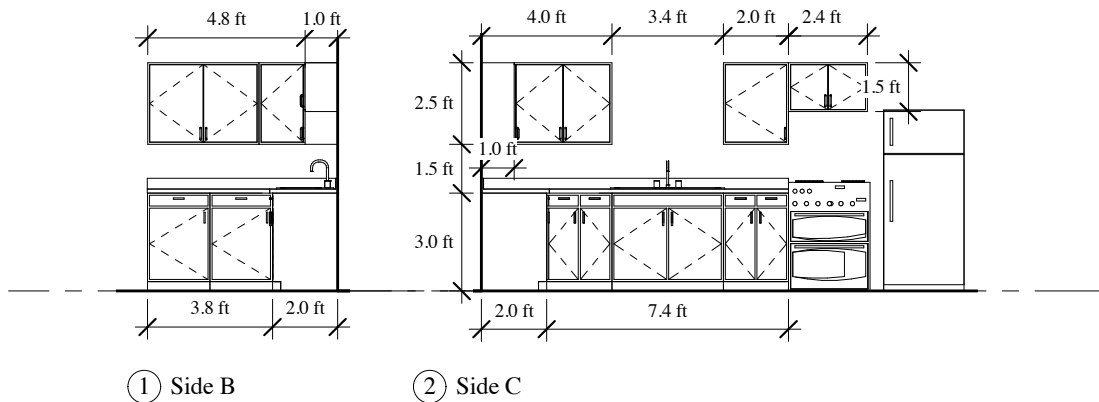

Figure 3.220: Wall and base cabinet locations, dimensions, and elevations within the kitchen for Experiment 18.

The ignition package located on the B/C corner counter was ignited ($t = 0$ s). The fire grew, causing a partial ceiling failure 465 s (7:45) post ignition. As the fire continued to grow, flames became visible from both side D windows 483 s (8:03) post ignition. Flames continuously vented from both windows 600 s (10:10) post ignition. Roughly 20 s later, the fire reached flashover, 620 s (10:20) post ignition. The fire then transitioned into a post-flashover state before any fire department intervention occurred.

Exterior water flow through the side D window (labeled 6 in Figure 3.219) began 720 s (12:00)

post ignition. The suppression crew utilized a steep angle to deflect water into the fire room off the ceiling for 14 s. The front door was opened 741 s (12:21) post ignition by the ventilation crew. The suppression crew advanced closer to the side D window for a secondary exterior water flow 743 s (12:23) post ignition for 7 s. The crew suppressed surface fire on the cabinets using an 'O' pattern. The suppression crew then transitioned into the structure through the side A door and made their way to the kitchen. Interior water flow began 828 s (13:48) post ignition and lasted for 25 s. The backup crew applied water on the exterior of the structure 910 s (15:10) post ignition to suppress flames on the side D exterior. The total tactic time, from exterior suppression to interior suppression, lasted 108 s (1:48). The total water flowed for initial suppression was 73 gal, 57 gal from the primary line and 16 gal from the secondary line. The total water flowed does not include water flowed during mop-up operations.

Two 1.75 in. hoselines with combination nozzles set to straight stream were used for suppression. The primary hoseline was placed on side D and utilized for exterior water application and the secondary hoseline was placed on side A and brought into the structure for interior water application. No additional ventilation beyond the front door was provided. Figure 3.221 shows the sequence of events with an isometric image of the structure.

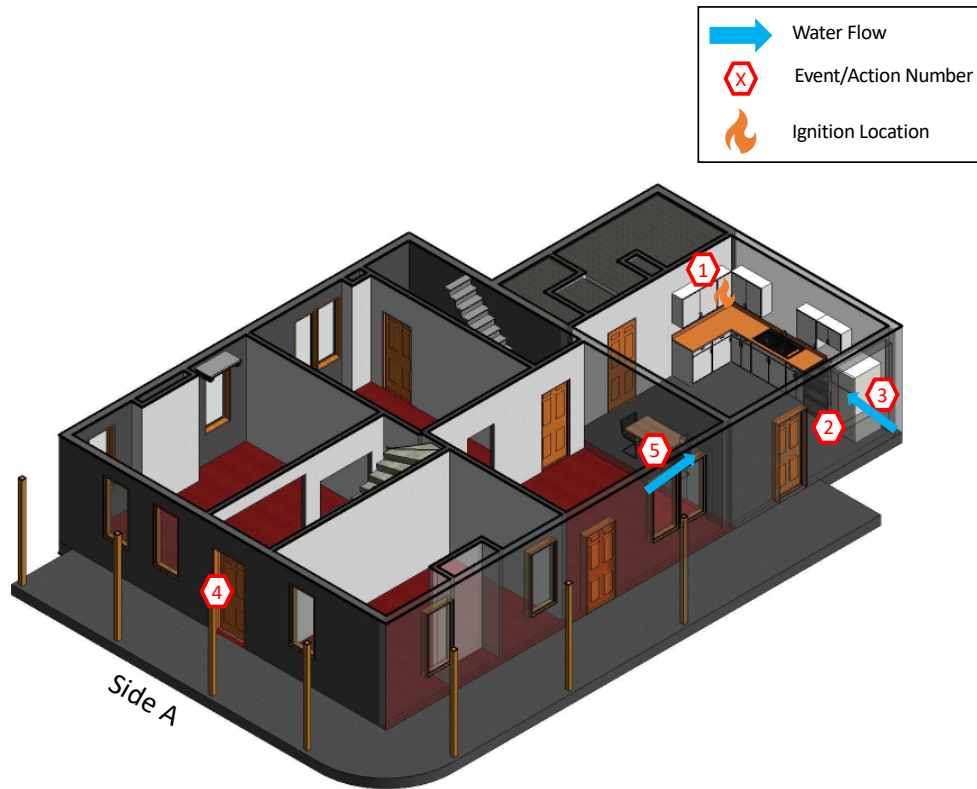

Action/Event	Time (mm:ss)	Time (s)
1 Ignition	00:00	0
2 Flashover	10:20	620
3 Exterior Flow	12:00	720
4 Front Door Open	12:21	741
5 Interior Flow	13:48	828

Figure 3.221: Time and sequence of actions and events for Experiment 18.

The fire room temperatures are shown in Figure 3.222. Kitchen ceiling temperatures began to increase approximately 250 s post ignition. Ceiling temperatures reached an initial peak of 1450 °F at 450 s post ignition. Temperatures at all elevations increased rapidly 30 s prior to flashover. Flashover occurred 620 s post ignition when floor temperatures exceeded 1100 °F and peaked to approximately 1800 °F. Post flashover, fire room temperatures decreased to approximately 1200 °F before increasing to 1600 °F 30 s before exterior water flow. Exterior water flow caused temperatures within the fire room to decrease. Temperatures continued to decrease while the suppression crew transitioned to and conducted interior water flow.

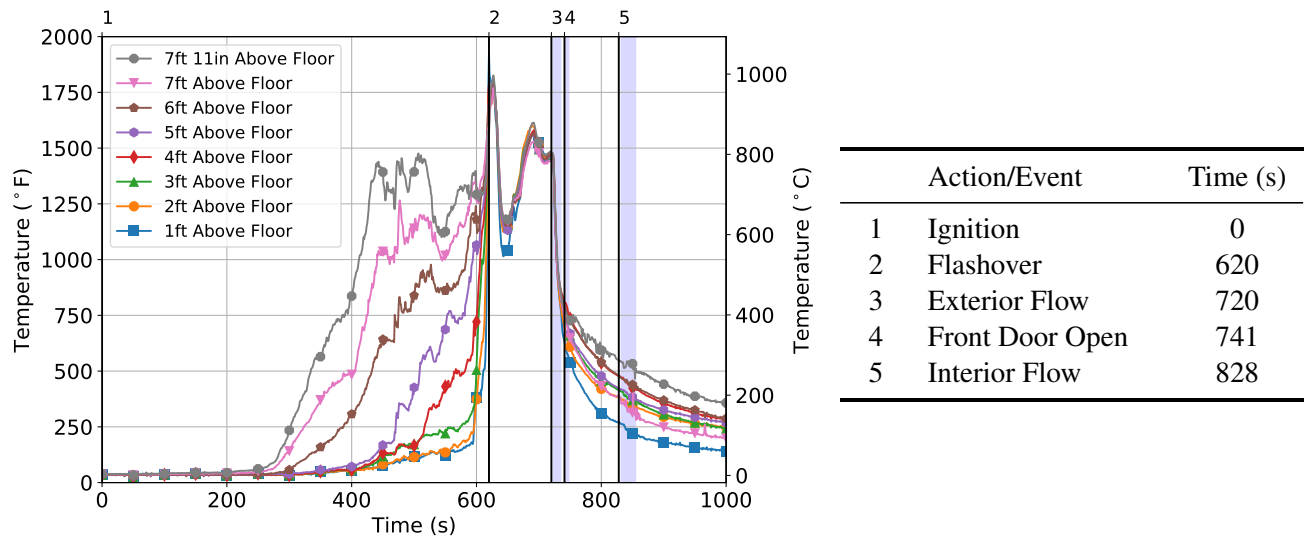

Figure 3.222: Temperatures in fire room (kitchen) for Experiment 18. Blue vertical bars indicate time and duration of water flow.

First-floor remote temperatures are presented in Figure 3.223. Temperatures remote from the kitchen responded relative to their proximity to the fire room. Dining room temperatures (see Figure 3.223a) began to increase around 350 s post ignition. At flashover, temperatures ceiling temperatures peaked at approximately 900 °F, while floor temperatures peaked at approximately 600 °F. Post flashover, temperatures became steady between 550°F and 750 °F. Exterior suppression 720 s post ignition decreased temperatures within the dining room (Action 3). Temperatures returned to pre-ignition conditions after interior suppression (Action 5).

Temperatures within the living room (see Figure 3.223b) began to increase around 450 s post ignition. Temperatures did not peak during flashover, but rather increased steadily until reaching a plateau ranging from 200°F to 400 °F above 2 ft. Temperatures remained elevated until suppression 720 s post ignition, after which temperatures decreased back to pre-ignition conditions.

Entryway temperatures (see Figure 3.223c) did not increase until approximately 500 s post ignition. Temperatures gradually increased until after flashover when temperatures reached an elevated plateau ranging from 50°F to 230 °F. Temperatures began to decrease after exterior suppression at 720 s post ignition and returned to near pre-ignition conditions before interior suppression at 828 s.

First-floor flex space temperatures (see Figure 3.223d) began to increase approximately 500 s post ignition. Temperatures increased gradually reaching a peak of approximately 120 °F. Exterior water flow caused temperatures to decrease toward pre-ignition conditions.

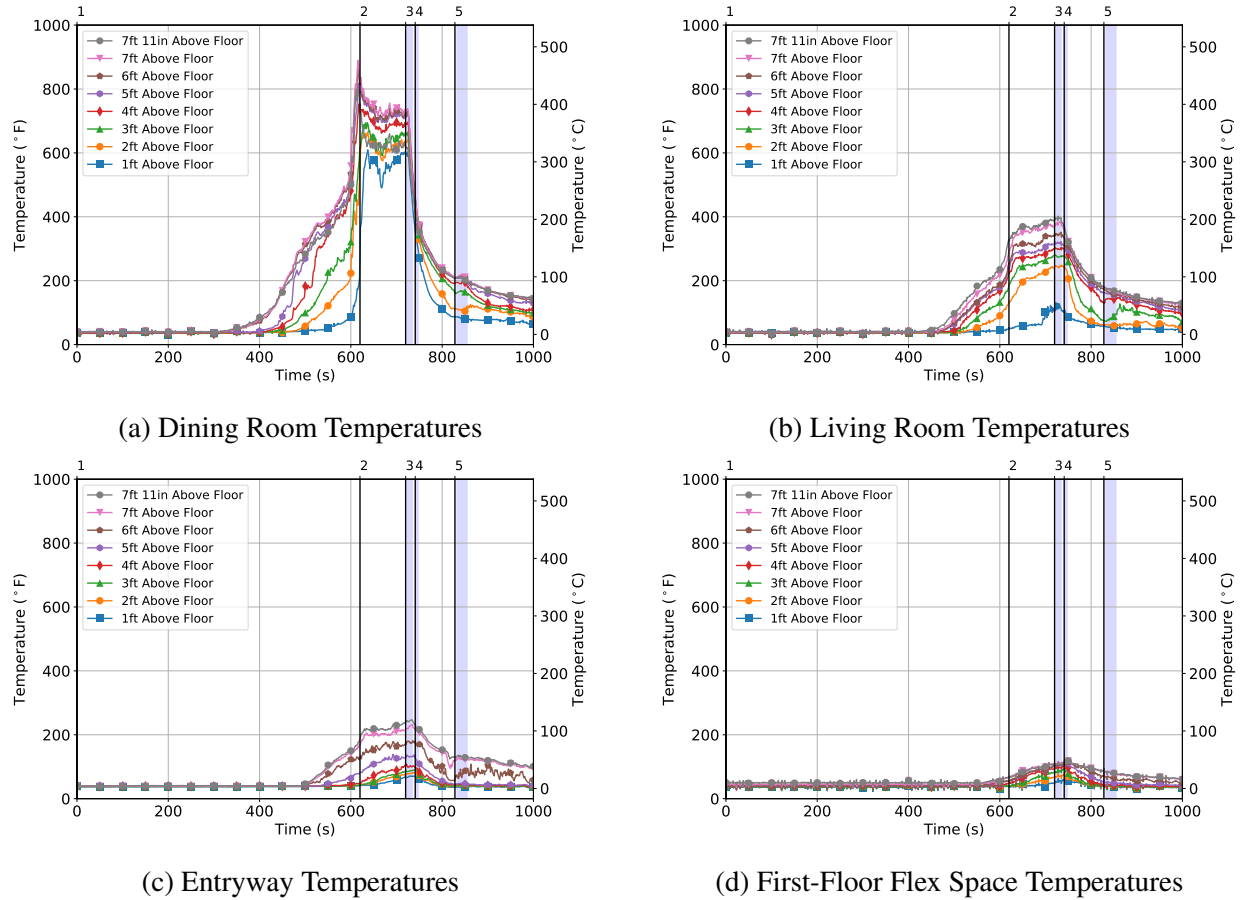

	Action/Event	Time (s)
1	Ignition	0
2	Flashover	620
3	Exterior Flow	720
4	Front Door Open	741
5	Interior Flow	828

Figure 3.223: Temperatures remote from the fire room on the fire floor for Experiment 18. Blue vertical bars indicate time and duration of water flow.

Second-floor temperatures are presented in Figure 3.224. Temperatures on the floor above the fire did not increase above 160 °F throughout the duration of the experiment. Hallway temperatures first increased approximately 550 s post ignition. Temperatures steadily increased as smoke traveled up to the second-floor, reaching a peak of approximately 150 °F during exterior water flow. Flex space temperatures began increasing approximately 560 s post ignition and peaked to 110 °F after exterior water flow (Action 3). Temperatures in both spaces decreased after exterior water flow (Action 5).

Temperatures within bedroom 1 (see Figure 3.224a), bedroom 2 (see Figure 3.224b), and bedroom 3 (see Figure 3.224d) behaved similarly, as all bedroom doors were open to the volume of

the second-floor. Temperatures in these spaces began gradually increasing after flashover. Temperatures increased during the duration of the experiment but remained below approximately 105 °F.

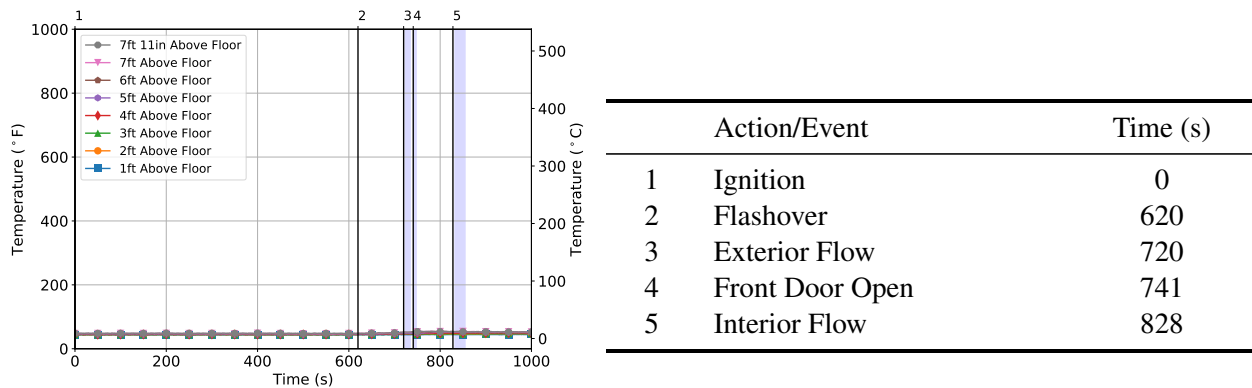

(a) Bedroom 1 Temperatures

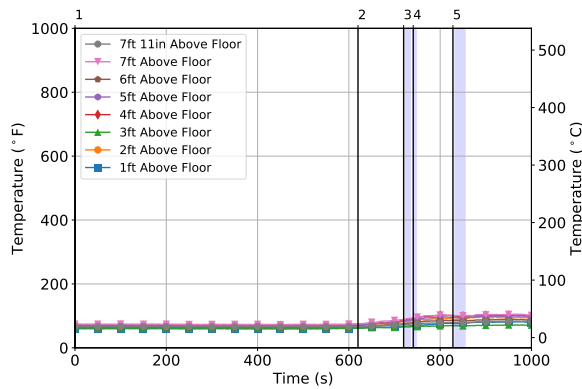

(b) Bedroom 2 Temperatures

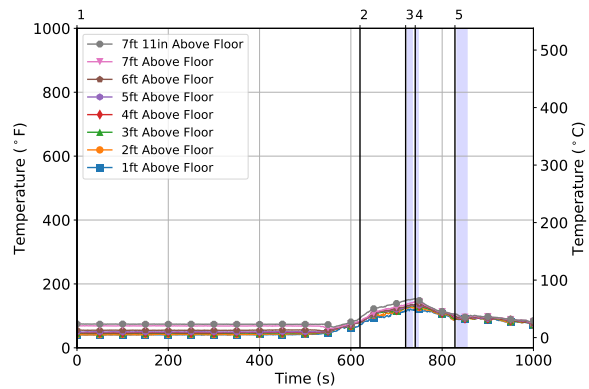

(c) Hallway Temperatures

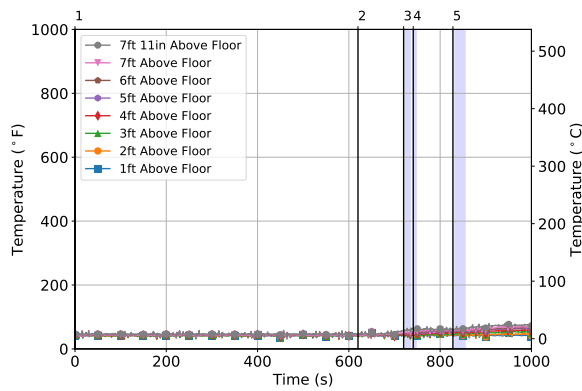

(d) Bedroom 3 Temperatures

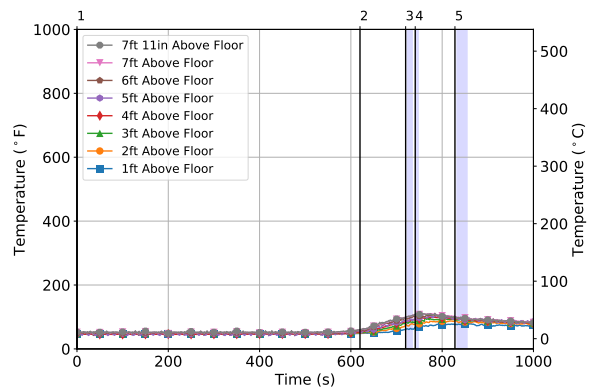

(e) Second-Floor Flex Space Temperatures

Figure 3.224: Remote temperatures on the floor above the fire room for Experiment 18. Blue vertical bars indicate time and duration of water flow.

Pressures recorded on the fire floor are presented in Figure 3.225. Kitchen pressures are presented in Figure 3.225a where the 7 ft elevation increased approximately 300 s post ignition due to gas

expansion. Pressure continued to increase, peaking during flashover to 12.6 Pa. Post-flashover the pressure at the 7 ft elevation remained steady around 8.0 Pa. Pressure at the 4 ft elevation remained steady near ambient conditions throughout the experiment, indicating its elevation was between the entrainment and exhaust flows. Pressure at the 1 ft elevation also began to decrease approximately 300 s post ignition as the fire entrained fresh air from remote areas within the structure. Pressure reached its minimum of -11.3 Pa approximately 40 s after flashover. Following exterior water flow 720 s post ignition, all pressures began to return toward ambient conditions. Pressures returned to ambient conditions after interior suppression.

Pressure within the dining room (see Figure 3.225b) began to change around 400 s post ignition. Pressure at the 7 ft elevation increased as hot gases gathered at the ceiling and peaked during flashover at 6.8 kW/m². Pressure at the 4 ft elevation remained near ambient throughout the experiment. Pressure at the 1 ft elevation decreased as air was entrained to the fire room. Pressure at all three elevations decreased as fire room temperatures decreased during post-flashover conditions, ranging from 0.6 Pa to 7.8 Pa. Pressures steadily trended toward ambient for the remainder of the experiment.

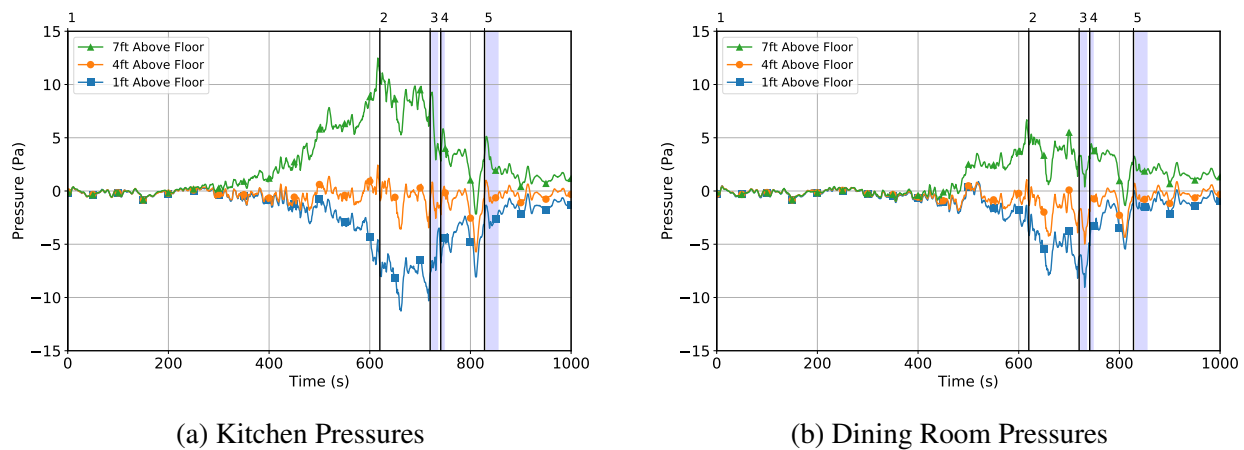

Action/Event	Time (s)
1 Ignition	0
2 Flashover	620
3 Exterior Flow	720
4 Front Door Open	741
5 Interior Flow	828

Figure 3.225: Pressures on the fire floor for Experiment 18. Blue vertical bars indicate time and duration of water flow.

Pressures recorded on the floor above the fire room are presented in Figure 3.226. Pressure within the hallway (see Figure 3.226c) decreased around 200 s post ignition; an indication entrainment of air from the second-floor. Prior to flashover, approximately 550 s post ignition, pressure at all three elevations in both the hallway and flex space increased. The second-floor became positively pressurized as hot gases traveled upward. Pressures peaked after the front door was opened ranging

from 3.6 Pa at the floor to 5.4 Pa at the ceiling and then subsequently returned toward ambient for the duration of the experiment. Pressures within bedroom 1, bedroom 2, and bedroom 3 were similar to one another. Pressures remained near atmospheric pressure until the front door was opened, when pressure increased at all three elevations.

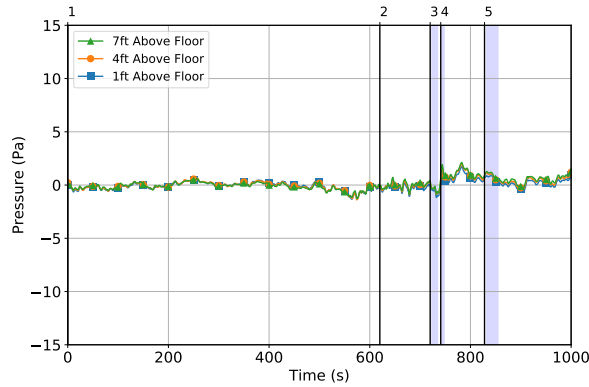

	Action/Event	Time (s)
1	Ignition	0
2	Flashover	620
3	Exterior Flow	720
4	Front Door Open	741
5	Interior Flow	828

(a) Bedroom 1 Pressures

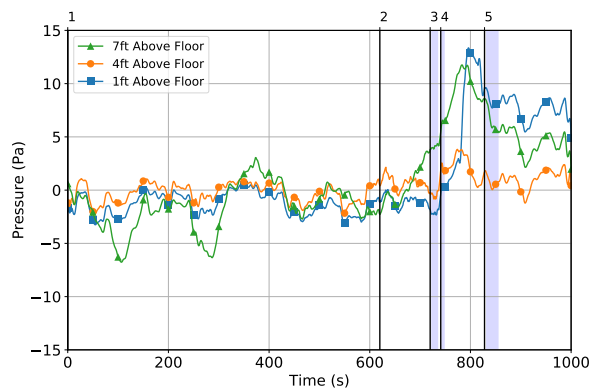

(b) Bedroom 2 Pressures

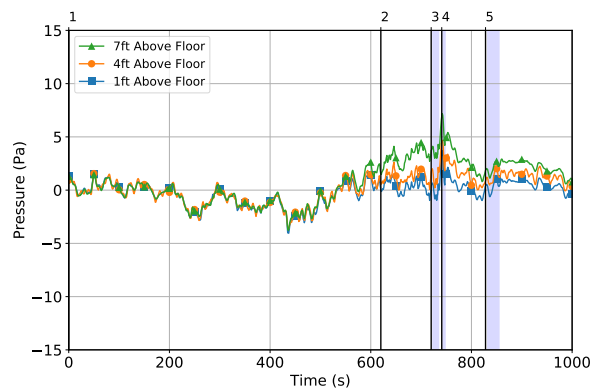

(c) Hallway Pressures

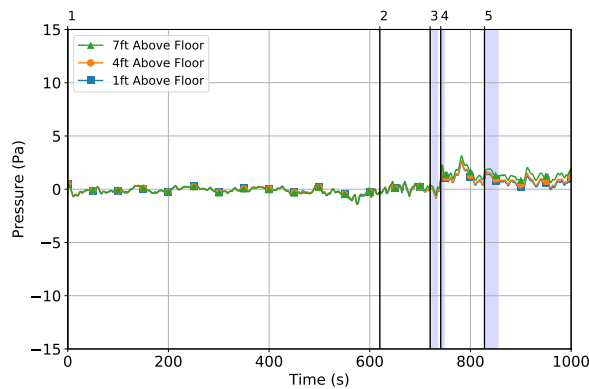

(d) Bedroom 3 Pressures

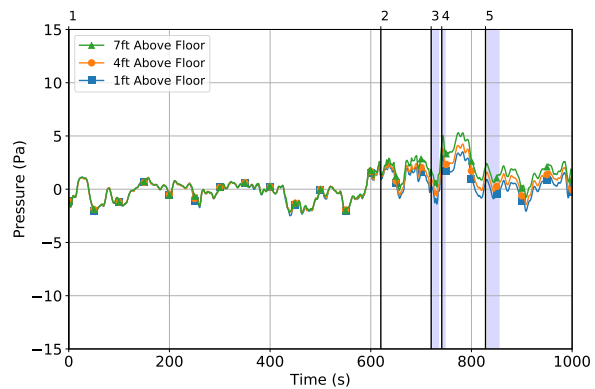

(e) Second-Floor Flex Space Pressures

Figure 3.226: Second-floor pressures remote from fire room for Experiment 18. Blue vertical bars indicate time and duration of water flow.

Figure 3.227 illustrates the flow of hot and cool gases throughout the structure. The kitchen fire initially created bi-directional flows through the open kitchen windows and doorway to the dining room (see Figure 3.227a). Pressure at the 7 ft elevation in the fire room was greater than the pressure at the same elevation in the dining room. Similarly, the pressure at the 1 ft elevation in the fire room was less than the pressure at the same elevation in the dining room. The gradient in pressure between the fire room and dining room confirms the exhaust of hot gases out of the fire room and entrainment of cool air into the fire room. The direction of flow did not change when the front door was opened (see Figure 3.227b), but the magnitude in each direction changed. Entrainment of air through the front door decreased the entrainment of air through the windows. As a result, exhaust through the windows increased and exhaust was established through the front door.



Figure 3.227: Changes in flow path for Experiment 18. Red arrows indicate flow out of the compartment, blue arrows indicate entrainment into the compartment, and the sizes of the arrows indicate the relative magnitude of the flow through each opening.

Dining room and flex space heat flux data are presented in Figure 3.228. Dining room heat flux was recorded at the 1 ft elevation. Flex space heat flux was recorded at both the 1 ft and 3 ft elevations. Neither location recorded a notable increase in heat flux throughout the experiment.

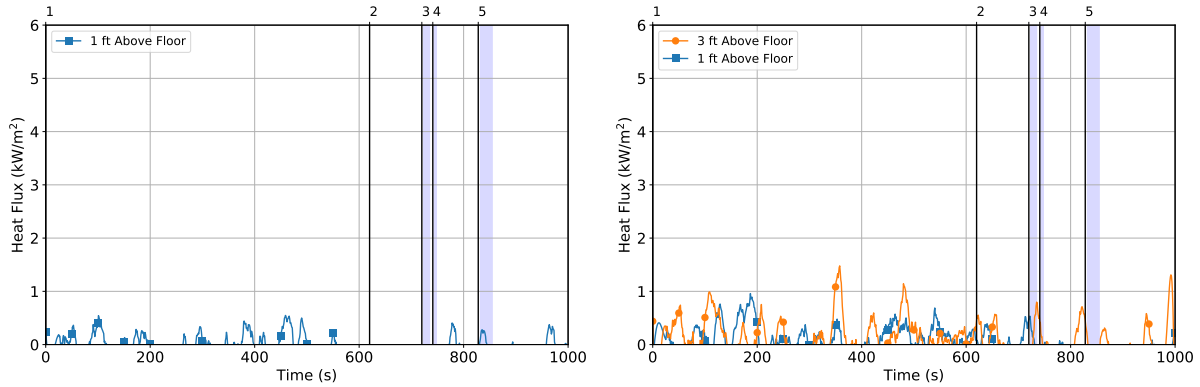

(a) Dining Room Heat Flux

(b) Flex Space Heat Fluxes

	Action/Event	Time (s)
1	Ignition	0
2	Flashover	620
3	Exterior Flow	720
4	Front Door Open	741
5	Interior Flow	828

Figure 3.228: Heat flux at remote locations for Experiment 18. Blue vertical bars indicate time and duration of water flow.

The aforementioned locations were also monitored for gas concentrations, of CO, CO₂, and O₂. Gas concentration data is presented in Figure 3.229. Dining room O₂ concentration began to decrease while CO and CO₂ concentrations began to increase approximately 560 s post ignition (see Figure 3.229a). Gas concentrations steadily trended away from ambient, coming to a local peak during the first exterior water flow of 18.8% O₂, 2.4% CO₂, and 0.3% CO. The first exterior water flow decreased gas concentrations. During the 9 s of no flow between the first and second exterior water flows, the gas concentrations began to worsen, peaking during the second exterior water flow to 18.6% O₂, 2.8% CO₂, and 0.4% CO. After the second exterior water flow, gas concentrations began trending back toward ambient.

Flex space gas concentrations (see Figure 3.229b) began to change approximately 640 s post ignition for both elevations. Gas concentrations increased without impact from exterior or interior water flow to peak at both elevations approximately 910 s post ignition. Conditions at the 3 ft elevation were worse than at the 1 ft elevation for the entire experiment. Peak concentrations were 15.8% O₂, 5.2% CO₂, and 0.9% CO approximately 910 s post ignition.

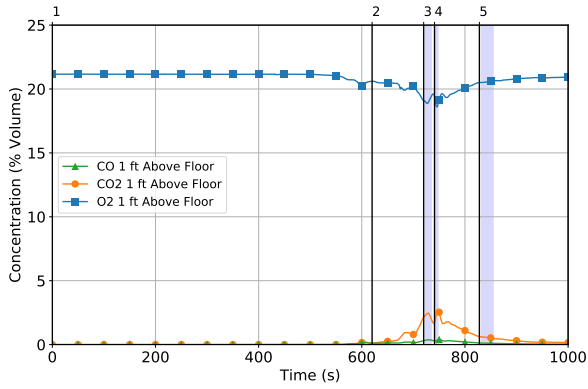

(a) Dining Room Gas Concentrations

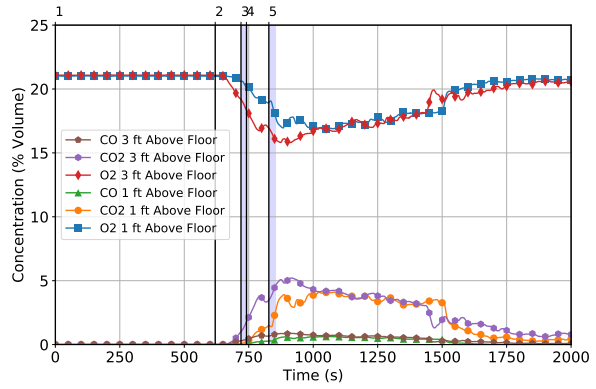

(b) Flex Space Gas Concentrations

	Action/Event	Time (s)
1	Ignition	0
2	Flashover	620
3	Exterior Flow	720
4	Front Door Open	741
5	Interior Flow	828

Figure 3.229: Gas concentrations at remote locations for Experiment 18. Figure 3.229b ends at 2000 s post ignition to indicate that gas concentrations returns to ambient. Blue vertical bars indicate time and duration of water flow.

3.19 Experiment 19 — Exterior Fire Control with Additional Horizontal Ventilation

Experiment 19 was conducted to examine exterior water flow followed by interior water flow with additional horizontal ventilation. Between exterior and interior water flows, the front door was opened and additional ventilation was provided by opening windows on sides A, B, and D of the structure. A one-and-a-half-story, single-family home located at 732 Broadway Avenue in Sidney, Ohio, was instrumented to conduct this first-floor kitchen fire experiment. Exterior photos of this wood-framed structure appears in Figure 3.230. The structure was built with rough cut lumber framing finished with layers of wood slat, foam insulation, and metal siding. The foundation was a mix of poured concrete and concrete block. The peaked style roof was constructed using 1 in.-by-6 in. sheathing covered with asphalt shingles. Interior walls were finished with a combination of plaster and lath, plasterboard, plywood, wood slat, and wood panels. Interior floors were finished with vinyl tile in the kitchen and vinyl wood in all other areas. Detailed dimensioned drawings for each floor of the structure appear in Appendix Figures B.5 and B.6.



(a) Side A



(b) B/C Corner



(c) Side C



(d) Side D

Figure 3.230: Exterior photographs of the structure for Experiment 19.

The first-floor had an entry-room, dining room, flex space, kitchen, and rear entry. The second-floor had two bedrooms. A stairwell located off the kitchen connected the two floors. These areas defined the experimental volume of the structure. The B/C corner bathroom was separated from this volume and used as instrumentation space. The fire was ignited in the first-floor kitchen. The structure was instrumented for temperature, pressure, heat flux, IR, and standard video to capture the fire dynamics during experimentation. Instrumentation was also installed to characterize the potential for skin burns and occupant toxic exposure during the experiment. Figure 3.231 shows the layout of the structure with the instrumentation locations.

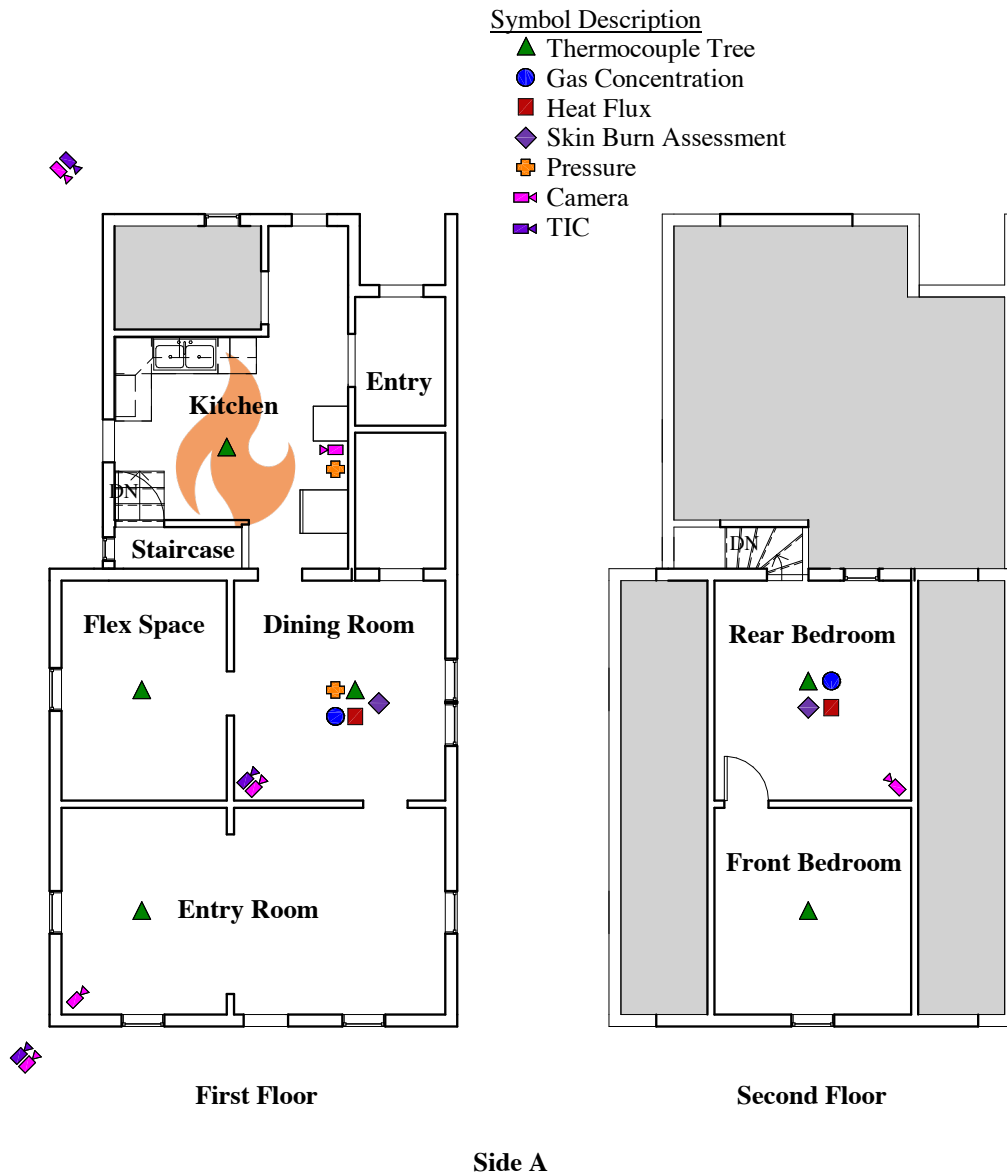

Figure 3.231: Instrumentation and floor plan for Experiment 19. The gray areas were isolated from the remainder of the structure and utilized as space for instrumentation.

The fire room was furnished with the kitchen fuel package described in Section 2.4.2 and contained a range, refrigerator, table, and two chairs. The ignition location was immediately surrounded by a large bag of potato chips, three paper towel rolls, and a coffee maker. The wall cabinets contained approximately 1250 paper cups. Five paper towel rolls were placed on top of the range hood and eight paper towel rolls were placed on top of the refrigerator. The kitchen windows located on sides B and C were removed prior to ignition to ensure repeatable fire growth and a sufficient oxygen supply for flashover. Photographs of the fire room prior to ignition are presented in Figure 3.232. A dimensioned layout of the kitchen is included in Figure 3.233. A detailed drawing of the kitchen cabinets is included in Figure 3.234.



(a) B/C Corner

(b) Side C



(c) Side D

Figure 3.232: Interior photographs of fire room for Experiment 19.

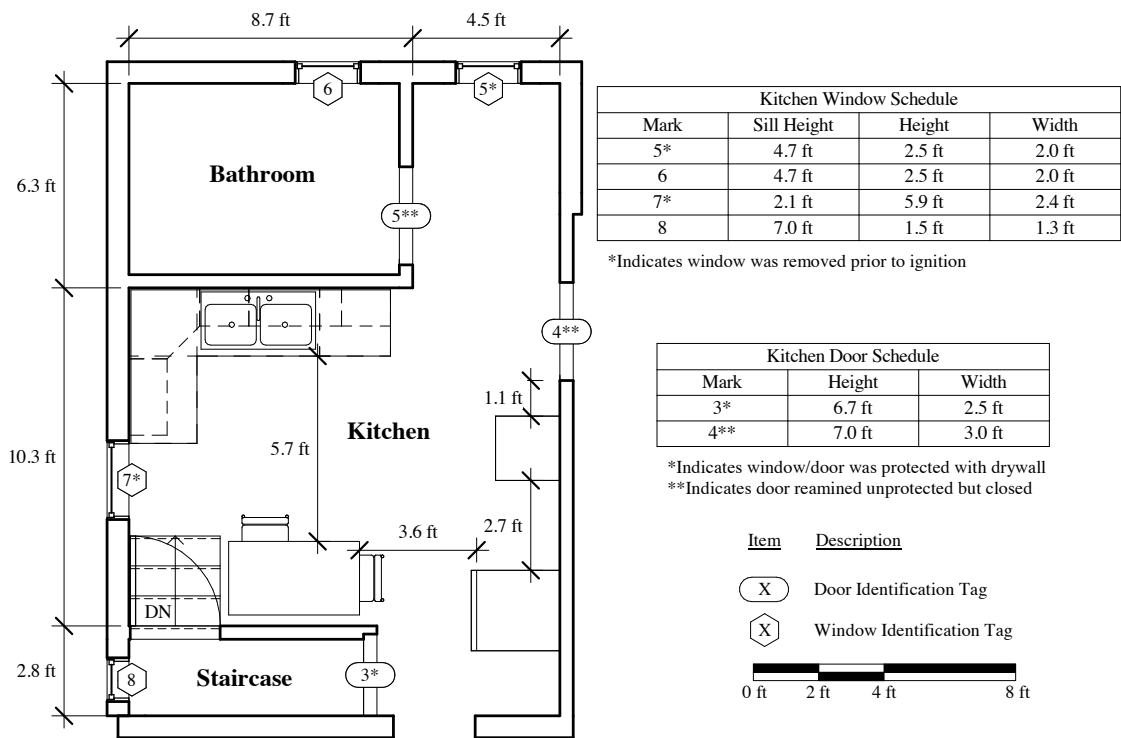

Figure 3.233: Fire room layout for Experiment 19.

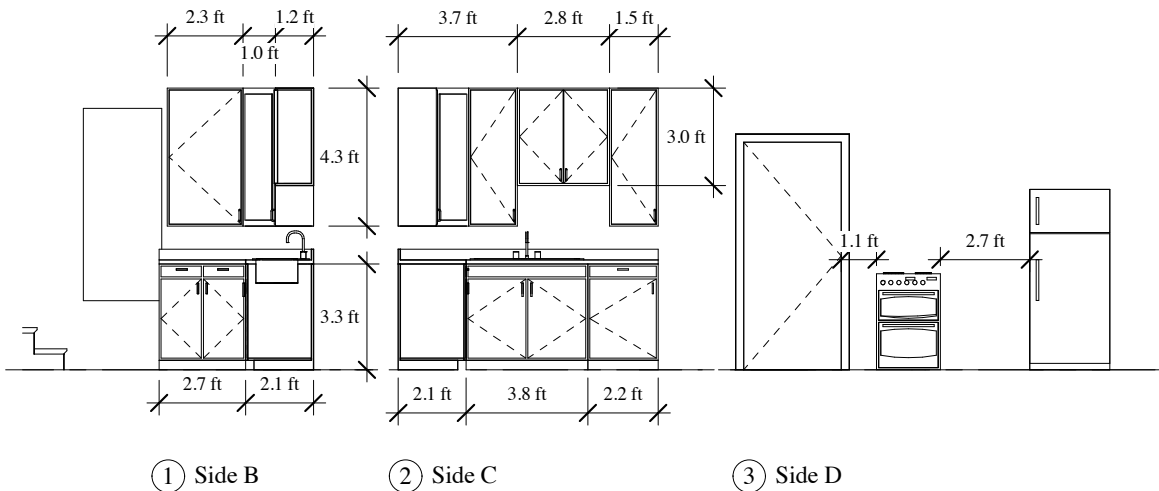

Figure 3.234: Wall and base cabinet locations, dimensions, and elevations within the kitchen for Experiment 19.

The ignition package surrounding the ignition location on the B/C corner counter was ignited ($t =$

0 s). The fire grew, producing flames from the side B window 433 s (7:13) post ignition. The fire spread, igniting the kitchen floor and paper towel rolls located on top of the refrigerator 477 s (7:57) post ignition. Flames continuously vented from the side B window 482 s (8:02) post ignition, just prior to flames present in the dining room 491 s (8:11) post ignition. The fire continued to grow until flashover occurred 521 s (8:41) post ignition. The fire transitioned into a post-flashover state prior to any fire department intervention.

Exterior water flow began 660 s (11:00) post ignition through the side B window (labeled 7 in Figure 3.233) for approximately 10 s. Approximately 675 s (11:15) post ignition, two fire department interventions occurred simultaneously: a secondary exterior water flow (7 s in duration), and opening the front door. The ventilation crew broke windows on sides A, B, and D 682 s (11:22) post ignition. The suppression crew transitioned into the structure for interior water flow. The first interior water flow application was initiated 753 s (12:33) post ignition and lasted 16 s. A secondary interior water flow application occurred 799 s (13:19) post ignition for 15 s. The total tactic time, from exterior water flow to interior water flow, was 93 s (1:33). Total water flowed during initial suppression was 108 gal, which did not include water flowed during mop-up operations.

One 1.75 in. hoseline with a combination nozzle set to straight stream was used for both exterior and interior water flow. The line was initially placed on side B of the structure for exterior flow. It was moved to side A and brought into the structure for interior suppression. Figure 3.235 shows the sequence of events with an isometric image of the structure.

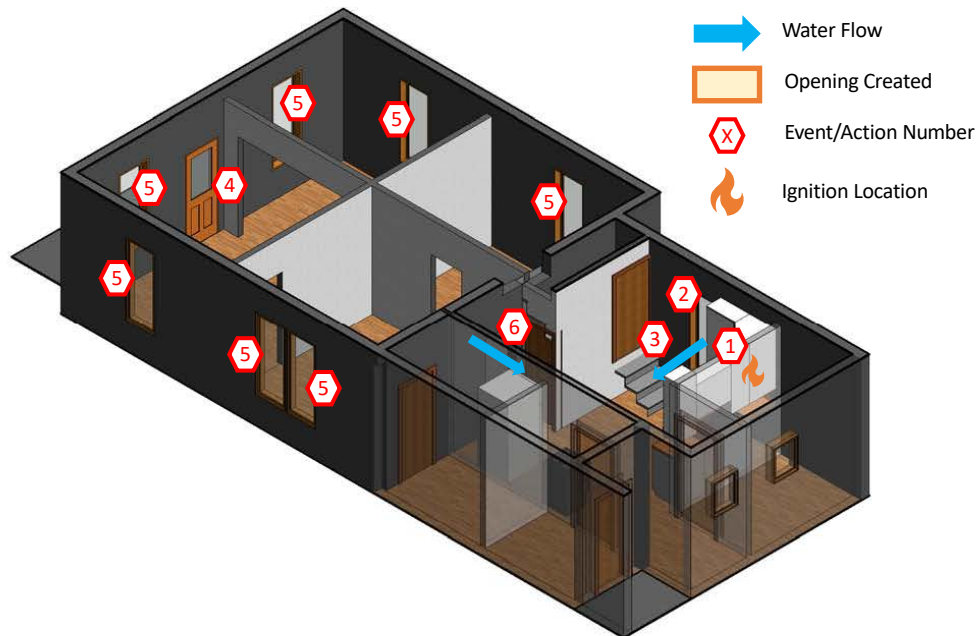

Action/Event	Time (mm:ss)	Time (s)
1 Ignition	00:00	0
2 Flashover	08:41	521
3 Exterior Flow	11:00	660
4 Front Door Open	11:15	675
5 Window Ventilation	11:22	682
6 Interior Flow	12:33	753

Figure 3.235: Time and sequence of actions and events for Experiment 19.

Temperatures recorded in the fire room are shown in Figure 3.236. Temperatures near the ceiling began to increase approximately 20 s post ignition. Temperatures at the ceiling reached a plateau of approximately 1600 °F 450 s post ignition. Temperatures at all other elevations began to increase around 425 s post ignition, increasing rapidly within the 30 s prior to flashover. Flashover occurred 521 s post ignition when temperatures at the floor exceeded 1100 °F, peaking to 1500 °F. Post-flashover temperatures decreased for approximately 30 s before increasing to a local peak of approximately 1700 °F. After which, temperatures decreased until just prior to exterior water flow, when they increased slightly. Exterior water flow reduced fire room temperatures. Interior water flow decreased fire room temperatures further.

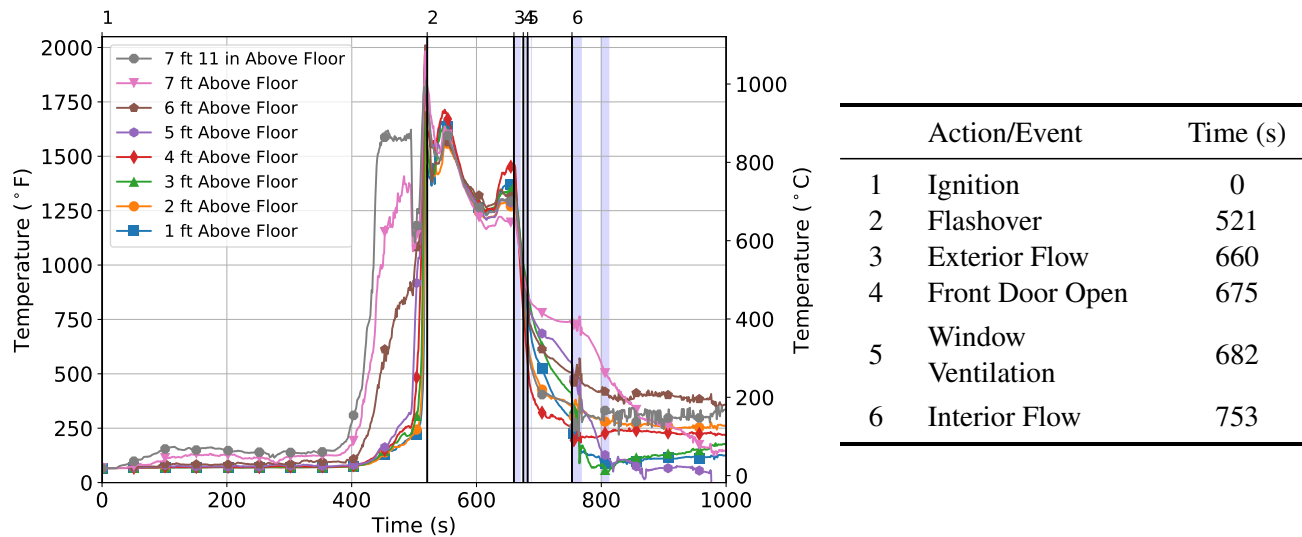
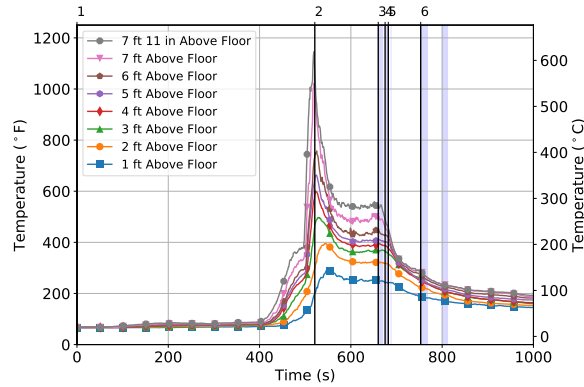

Figure 3.236: Temperatures in fire room (kitchen) for Experiment 19. Blue vertical bars indicate time and duration of water flow.

Temperature data recorded from remote areas within the structure are presented in Figure 3.237. Temperatures on the second-floor in the rear bedroom (see Figure 3.237a) began to increase around 400 s post ignition. Temperatures peaked during flashover 521 s post ignition, ranging from 1200 °F at the ceiling to 300 °F at the floor. Post-flashover temperatures decreased initially but became steady between 250°F to 550 °F 575 s post ignition. Temperatures began to decrease during exterior water flow and decreased permanently after interior water flow.

Dining room temperatures nearest the ceiling (see Figure 3.237b) increased around 400 s post ignition, followed by temperatures near the floor just prior to flashover. At flashover, temperatures 5 ft and above peaked between 460°F and 800 °F. Post-flashover temperatures within the dining room were steady between 230°F and 630 °F until exterior water flow. Upon which, temperatures decreased steadily until the fire was extinguished with the interior flow.

Flex space temperatures (see Figure 3.237c) began to increase around 450 s post ignition. All temperatures above 1 ft in elevation increased just prior to flashover 521 s post ignition. Post-flashover temperatures within this space were steady between 200 °F and 450 °F until exterior suppression began. Exterior water flow 660 s post ignition caused temperatures to decrease to ambient conditions.



Action/Event	Time (s)
1 Ignition	0
2 Flashover	521
3 Exterior Flow	660
4 Front Door Open	675
5 Window Ventilation	682
6 Interior Flow	753

(a) Rear Bedroom Temperatures

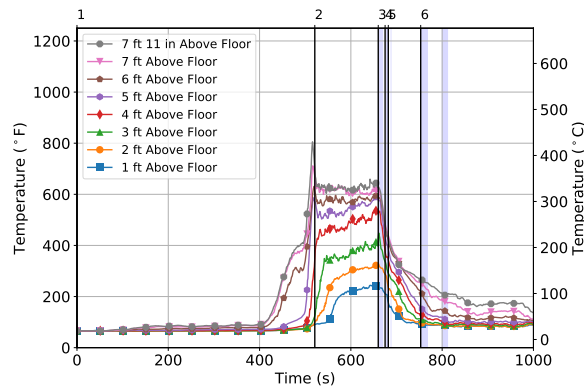

(b) Dining Room Temperatures

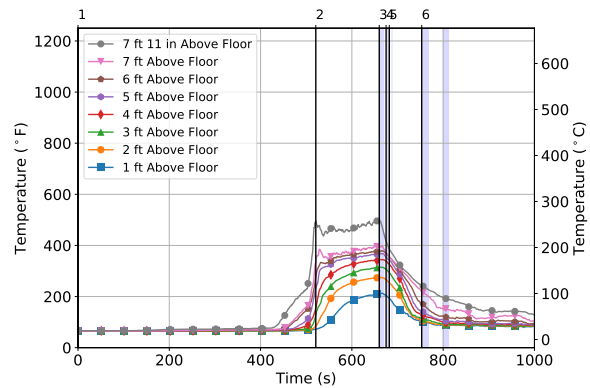

(c) Flex Space Temperatures

Figure 3.237: Temperatures remote from the fire room for Experiment 19. Blue vertical bars indicate time and duration of water flow.

Kitchen pressures were constant until approximately 400 s post ignition. Pressure near the ceiling increased as the production of hot gases accumulated at the ceiling and peaked to 10.6 Pa during flashover. Pressure at the 4 ft elevation remained near ambient until flashover, when it peaked to 2.5 Pa. Pressure at the 1 ft elevation decreased as the fire entrained air to sustain combustion. It reached a minimum at flashover of approximately -10.0 Pa. Pressures became stable after flashover 521 s post ignition with the 7 ft elevation near 7.0 Pa, the 4 ft elevation near ambient, and the 1 ft elevation near -9.0 Pa. Exterior suppression caused the 7 ft and 1 ft pressures elevations to decrease back to atmospheric pressure. Note this action led to a failure at the 4 ft elevation, likely due to the probe filling with water.

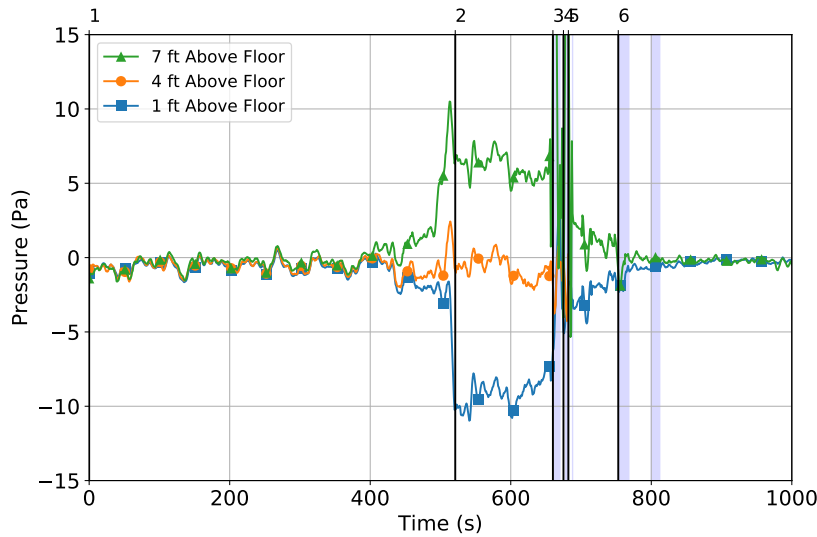

	Action/Event	Time (s)
1	Ignition	0
2	Flashover	521
3	Exterior Flow	660
4	Front Door Open	675
5	Window Ventilation	682
6	Interior Flow	753

Figure 3.238: Pressures in the fire room (kitchen) for Experiment 19. The pressure at the 4 ft elevation was compromised from the water stream. Blue vertical bars indicate time and duration of water flow.

Pressure remote from the fire room is presented in Figure 3.239. Dining room pressures did not begin to change until approximately 400 s post ignition. Pressure at the 7 ft elevation increased as hot gases gathered at the ceiling, peaking during flashover to 7.3 Pa. Pressure at the 4 ft elevation remained near ambient. Pressure at the 1 ft elevation decreased as the fire entrained cool air, coming to a steady peak near -4.0 Pa during post-flashover conditions. Exterior suppression caused pressures to return to atmospheric pressure.

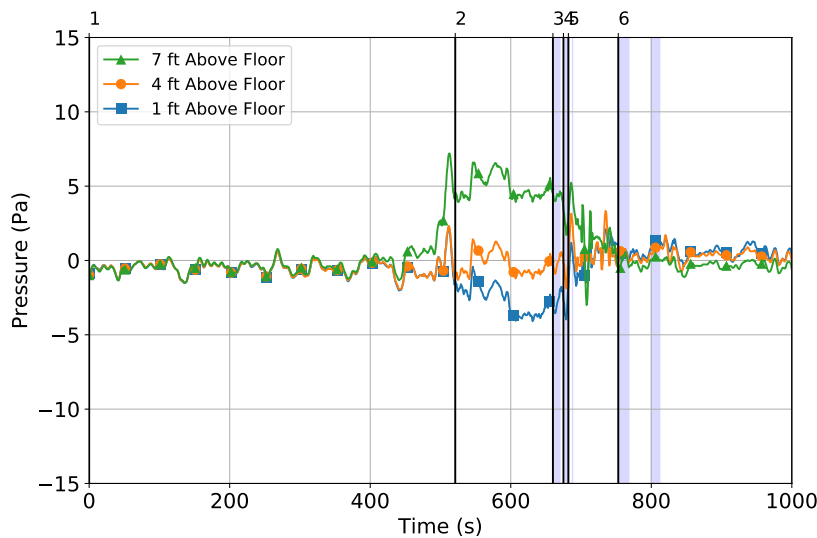

	Action/Event	Time (s)
1	Ignition	0
2	Flashover	521
3	Exterior Flow	660
4	Front Door Open	675
5	Window Ventilation	682
6	Interior Flow	753

Figure 3.239: Pressure remote from fire room for Experiment 19. Blue vertical bars indicate time and duration of water flow.

The changes in flow before and after fire department intervention are presented in Figure 3.240. The kitchen fire initially created bi-directional flows (see Figure 3.240a) throughout the open windows on sides B and C, the stair to the second floor and the doorway to the dining room. The differences in pressure between the fire room and dining room confirm these flows. Pressure at the 7 ft elevation in the fire room was greater than the pressure at the same height in the dining room. Similarly, pressure at the 1 ft elevation in the fire room was less than the pressure at the same elevation in the dining room. The gradient in pressure between the fire room and dining room resulted in the exhaust of hot gases and entrainment of cool air out of and into the fire room, respectively. Opening the front door did not change the direction of flow, but rather changed the magnitude of the flows (see Figure 3.240b). The new air inlet allowed more exhaust to exit the structure through the open kitchen windows. Additional ventilation (see Figure 3.240c) created more inlet and exhaust sources. Additional air was entrained through these openings, but also additional hot gases were exhausted through these openings.

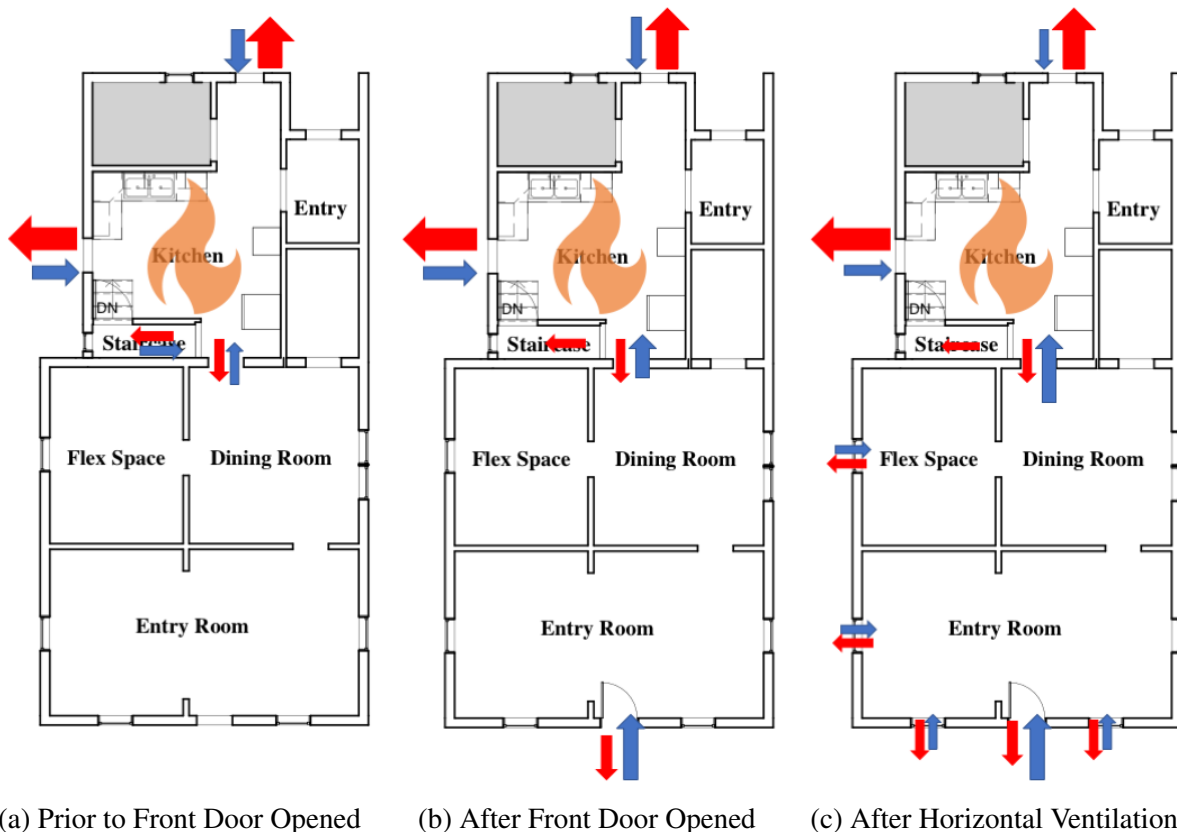
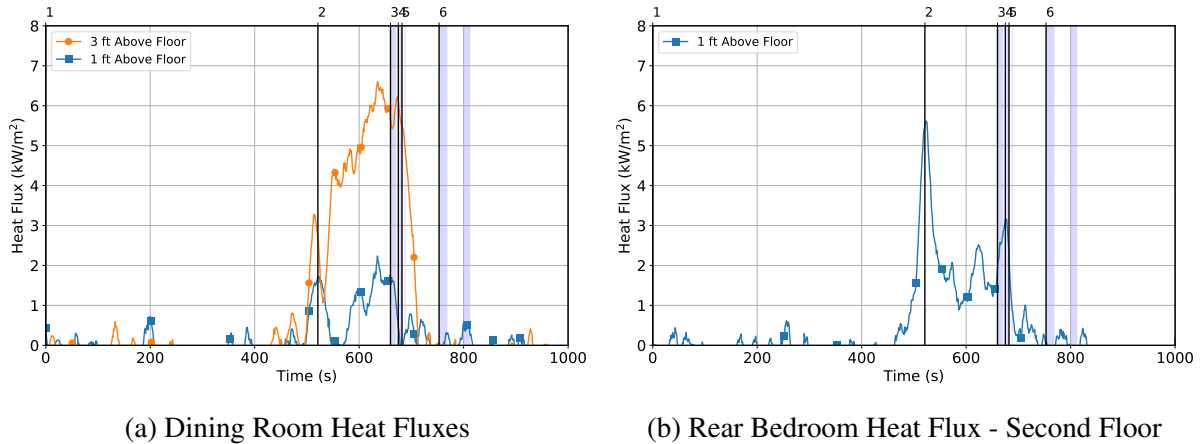

Figure 3.240: Changes in flow path for Experiment 19. Red arrows indicate flow out of the compartment, blue arrows indicate entrainment into the compartment, and the sizes of the arrows indicate the relative magnitude of the flow through each opening.

Dining room and rear bedroom heat flux data are presented in Figure 3.241. Dining room heat flux began to increase 30 s prior to flashover. Conditions at the 3 ft elevation were generally worse than at the 1 ft elevation. Heat flux at both elevations locally peaked at flashover to 3.3 kW/m^2 and 1.7 kW/m^2 , respectively. Post-flashover the heat flux at both elevations to decrease for approx-

imately 20 s before increasing again to peak values of 6.6 kW/m² and 2.2 kW/m², respectively. Exterior suppression caused the heat flux at both elevations decreased to ambient conditions. Rear bedroom heat flux (see Figure 3.241b) began to increase 60 s prior to flashover. Heat flux peaked at flashover to 5.6 kW/m². Post-flashover the heat flux decreased to approximately 2.0 kW/m². Exterior suppression caused the heat flux to decrease to ambient conditions.



	Action/Event	Time (s)
1	Ignition	0
2	Flashover	521
3	Exterior Flow	660
4	Front Door Open	675
5	Window Ventilation	682
6	Interior Flow	753

Figure 3.241: Heat flux at remote locations for Experiment 19. Blue vertical bars indicate time and duration of water flow.

Gas concentration (CO, CO₂, and O₂) data for remote locations within the structure is presented in Figure 3.242. Dining room gas concentrations did not begin to change until after flashover, approximately 575 s post ignition. As O₂ concentration decreased, CO and CO₂ concentrations increased. Conditions at the 3 ft elevation were worse than at the 1 ft elevation. Gas concentrations peaked during exterior water flow approximately 660 s post ignition. The 3 ft elevation gas concentrations were 3.0% O₂, 25% CO₂, and 3.1% CO, while the 1 ft elevation gas concentrations were 10.1% O₂, 16.1% CO₂, and 1.7% CO. Exterior suppression caused gas concentrations to decrease, while interior suppression caused gas concentrations to return to ambient conditions.

Rear bedroom gas concentrations began to change prior to flashover 475 s post ignition. Gas concentrations peaked during exterior water flow at approximately 680 s to 3.5% O₂, 25% CO₂, and 3.0% CO. Gas concentrations began trending toward ambient after exterior suppression concluded.

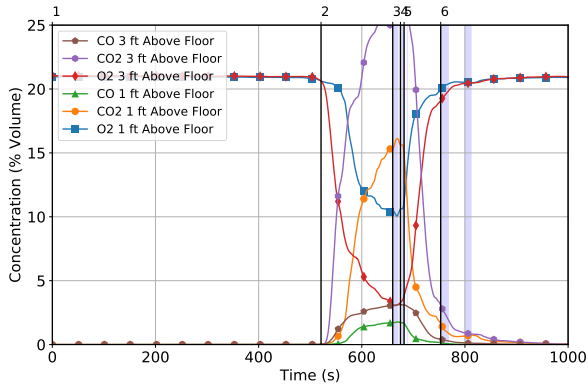

(a) Dining Room Gas Concentrations

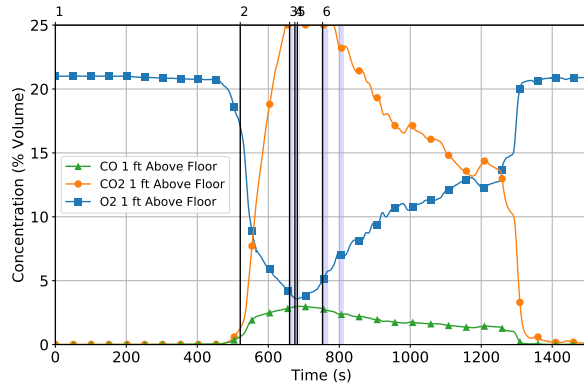

(b) Rear Bedroom Gas Concentrations

	Action/Event	Time (s)
1	Ignition	0
2	Flashover	521
3	Exterior Flow	660
4	Front Door Open	675
5	Window Ventilation	682
6	Interior Flow	753

Figure 3.242: Gas concentrations at remote locations for Experiment 19. Figure 3.242b ends 1500 s post ignition to show that gas concentration within the rear bedroom returned to ambient. At approximately 1320 s the second floor windows were opened. Blue vertical bars indicate time and duration of water flow.

3.20 Experiment 20 — Exterior Fire Control with Positive Pressure Ventilation

Experiment 20 was conducted to examine exterior water flow followed by an interior water flow with positive-pressure ventilation. Between the exterior and interior water applications, the front door was opened to make entry into the structure and horizontal ventilation aided by a positive pressure fan was conducted. A two-story, single-family home located at 1492 Dayton Xenia Road in Xenia, Ohio, was instrumented to conduct this first-floor kitchen fire experiment. Exterior photos of this structure appear in Figure 3.243. The structure was stick-built with rough cut lumber framing and wood-shake siding. The foundation was a mix of concrete block and stone. The hip-style roof was constructed using 1 in.-by-6 in. sheathing covered with asphalt shingles. Interior walls were finished mostly with plaster and lath, but the kitchen was finished with plasterboard. Interior floors were finished in a combination of wood in the entryway and living room, tile in the dining room, vinyl tile in the kitchen, and carpet in all other spaces. Detailed dimensioned drawings for each floor of the structure appear in Appendix Figures B.14 and B.15.



(a) Side A



(b) Side B



(c) Side C



(d) Side D

Figure 3.243: Exterior photographs of the structure for Experiment 20.

This experiment utilized the kitchen as the fire room. The first-floor included a living room, dining room, and a kitchen. The second-floor included three bedrooms. The stairwell located in the A/D corner connected the two floors. These areas defined the experimental volume of the structure. Various areas of the structure were protected and utilized for instrumentation. Figure 3.244 shows the layout of the structure with the instrumentation locations.

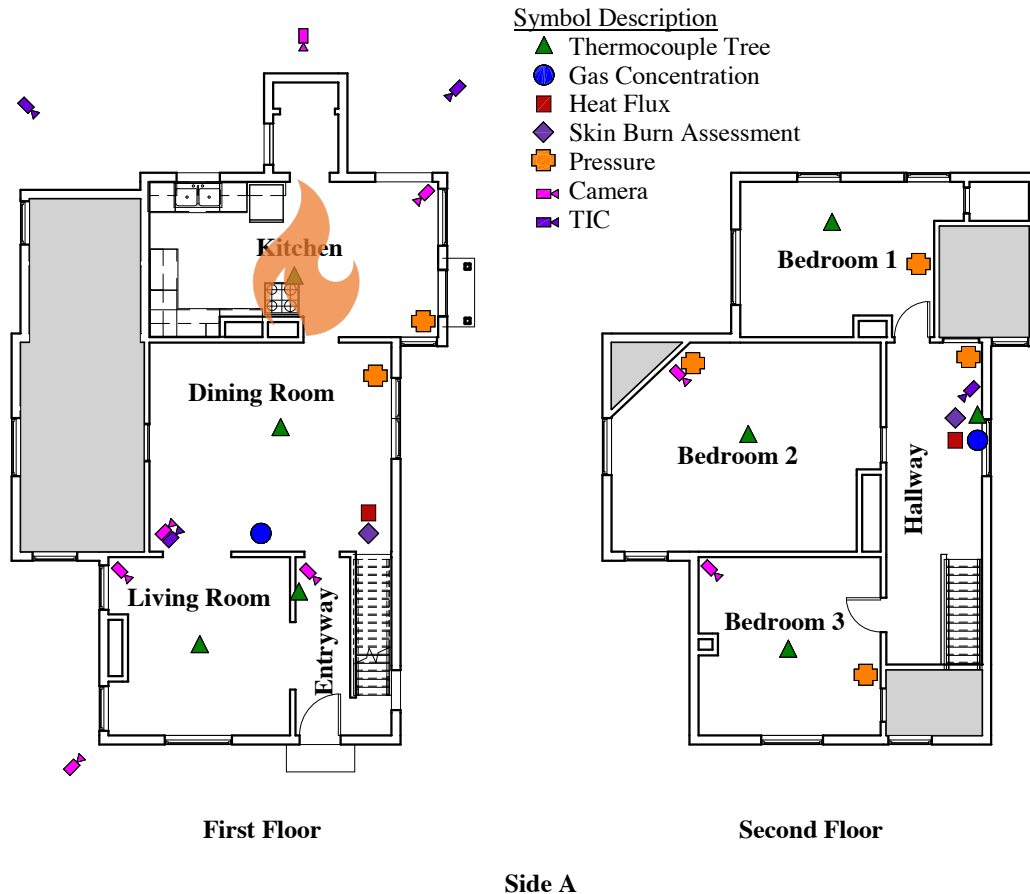

Figure 3.244: Instrumentation and floor plan for Experiment 20. The gray areas were isolated from the remainder of the structure and utilized as space for instrumentation.

The fire room was furnished with the kitchen fuel package described in Section 2.4.2 and contained a range, refrigerator, table, and two chairs. The ignition location was immediately surrounded by one large bag of potato chips, 16 paper towel rolls, and a coffee maker. Wall cabinets above the ignition location contained approximately 1250 paper cups. The two cabinets bordering the A/B corner (above the ignition location) were left open, exposing the fuel located inside. Two paper towel rolls were located on the side C counter. Five paper towel rolls were placed on top of the stove and six paper towel rolls were placed on top of the refrigerator. Both kitchen windows located on side C were removed prior to ignition to ensure repeatable fire growth and a sufficient oxygen supply for flashover. Photographs of the fire room prior to ignition are presented in Figure 3.245. A dimensioned layout of the kitchen is included in Figure 3.246. A detailed drawing of the kitchen

cabinets is included in Figure 3.247.



(a) A/D Corner



(b) Side B



(c) B/C Corner

Figure 3.245: Interior photographs of fire room for Experiment 20.

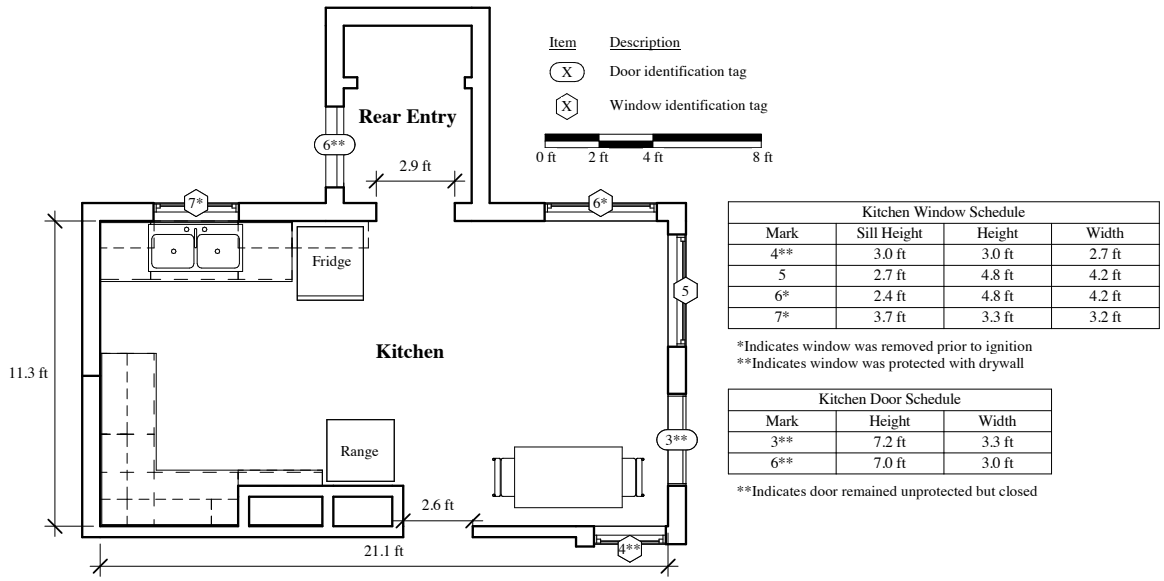

Figure 3.246: Fire room layout for Experiment 20.

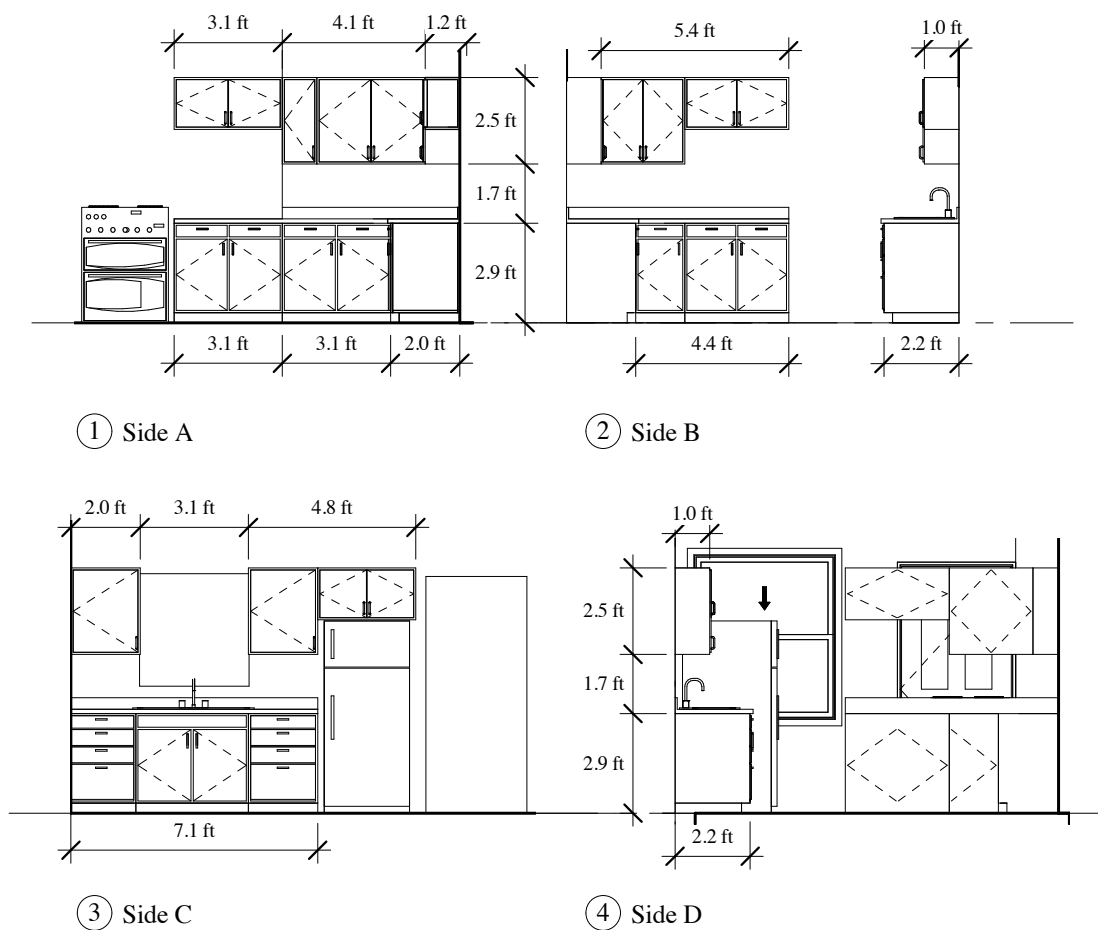

Figure 3.247: Wall and base cabinet locations, dimensions, and elevations within the kitchen for Experiment 20.

The fire was ignited in the A/B corner of the kitchen to begin the experiment ($t = 0$ s). Approximately 102 s (1:42) post ignition, flames were visible from the side C window (labeled 7 in Figure 3.246). Flames rolled along the ceiling at approximately 228 s (3:48) post ignition. The paper towel rolls located on top of the refrigerator ignited approximately 279 s (4:39) post ignition. Flames extended out window 7 337 s (5:37) post ignition, becoming continuous 385 s (6:25) post ignition. Flashover of the kitchen occurred 459 s (7:39) post ignition. The fire transitioned to post-flashover conditions before any fire department intervention.

Fire department intervention began with exterior flow through window 7 at 603 s (10:03) post ignition that lasted 13 s. The front door was opened 620 s (10:20) post ignition. The PPV fan was turned on prior to the front door opening and was turned into position 633 s (10:33) post ignition. The suppression crew transitioned into the structure to initiate interior flow 715 s (11:55) post ignition. Four interior water applications were conducted before the fire was considered extinguished. The total tactic time, from exterior water flow to interior water flow, was 112 s (1:52). The total water flowed for initial suppression was 103 gal, 74 gal from the primary line and 29 gal

from the secondary line. The total water flowed does not include the water flowed during mop-up operations.

Two hoselines were used to conduct the exterior and interior suppression. Both lines were 1.75 in. with a combination nozzle set to straight stream. The primary line was placed on side A and moved inside the structure for interior flow. The secondary line was placed on side C of the structure and used for exterior flow. Ventilation was aided with a positive pressure fan⁵. The fan was placed approximately 5 ft from the front door at an angle of roughly 95°. Firefighters ensured flow through the top of the doorway and that the fan was on full throttle. Figure 3.248 shows the sequence of events, including fire department interventions, with an isometric image of the structure.

⁵Manufacturer specifications: 18 in. diameter, gas-powered, 14,773 CFM.

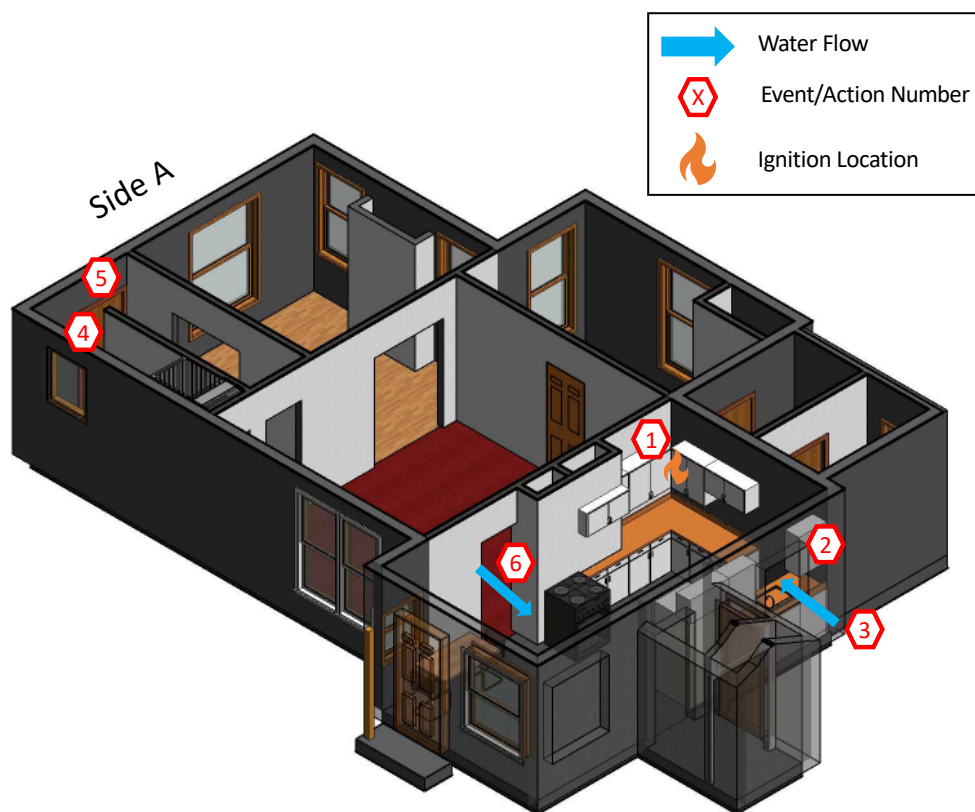

	Action/Event	Time (mm:ss)	Time (s)
1	Ignition	00:00	0
2	Flashover	07:39	459
3	Exterior Flow	10:03	603
4	Front Door Open	10:20	620
5	PPV Fan Turned In	10:33	633
6	Interior Flow	11:55	715

Figure 3.248: Time and sequence of actions and events for Experiment 20.

Temperatures from the thermocouple array located in the kitchen are presented in Figure 3.249. Temperatures nearest the ceiling began to increase at approximately 50 s post ignition, corresponding to the first visible flames on the camera view located in the kitchen. All temperatures within the fire room steadily increased until flashover occurred. At 459 s post ignition flashover occurred, all temperatures within the fire room had peaked. Post-flashover temperatures decreased initially and became stable near 1500 °F. Approximately 550 s post ignition, temperatures 3 ft and below decreased. Exterior water flow at 603 s post ignition caused temperatures at all elevations to decrease. Temperatures continued to decrease following interior water flow at 715 s post ignition.

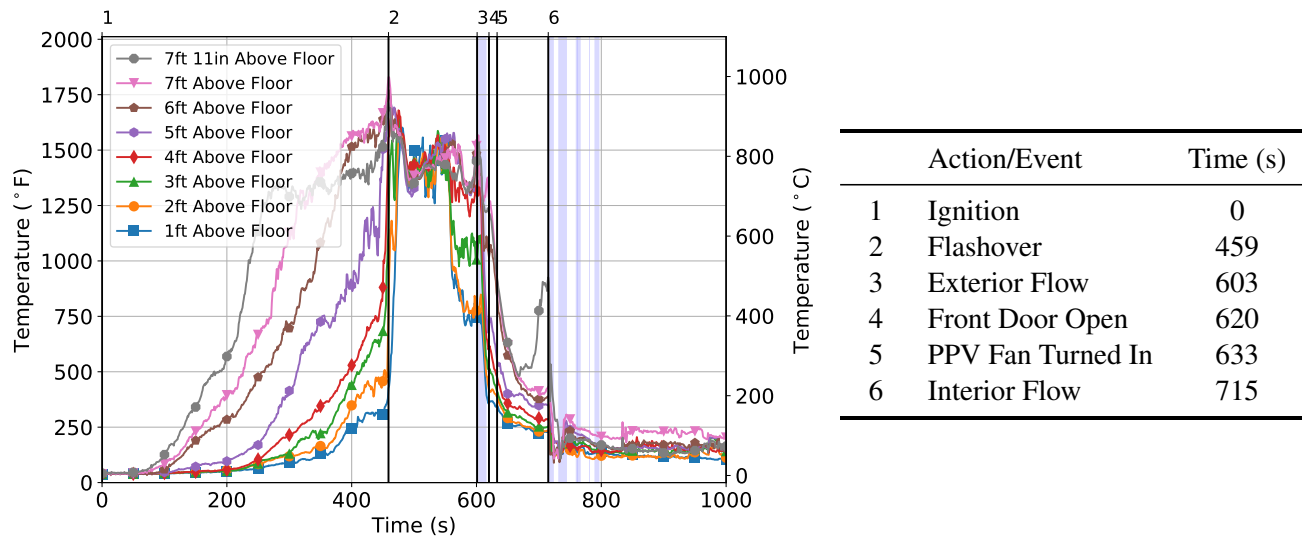
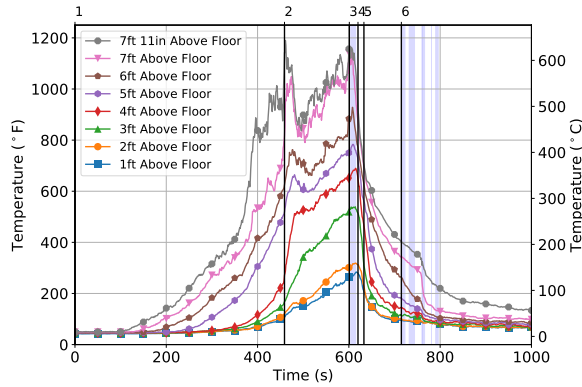

Figure 3.249: Temperatures in fire room (kitchen) for Experiment 20. Blue vertical bars indicate time and duration of water flow.

Temperatures on the fire floor, remote from the kitchen, are presented in Figure 3.250. Temperatures in the dining room began to increase at the ceiling approximately 100 s post ignition. Once flames began to enter the dining room at 363 s post ignition, temperatures 4 ft and below began to increase. Temperatures 3 ft and above increased just after flashover occurred at 469 s post ignition. Temperatures steadily increased post-flashover but decreased after exterior water flow 603 s post ignition. Temperatures returned to ambient conditions post interior water flow at 715 s post ignition.

Temperatures within the living room and entryway began to increase just after 200 s post ignition, corresponding to the flames in the kitchen reaching the ceiling. Temperatures in both locations peaked just after flashover approximately at 490 s post ignition then decreased for 20 s. Temperatures steadily increased until exterior suppression began at 603 s post ignition. Temperatures within the entryway returned to ambient before interior water flow was conducted because it was closer in proximity to the open doorway. Temperatures within the living room decreased to ambient after interior suppression at 715 s post ignition.



	Action/Event	Time (s)
1	Ignition	0
2	Flashover	459
3	Exterior Flow	601
4	Front Door Open	620
5	PPV Fan Turned In	633
6	Interior Flow	715

(a) Dining Room Temperatures

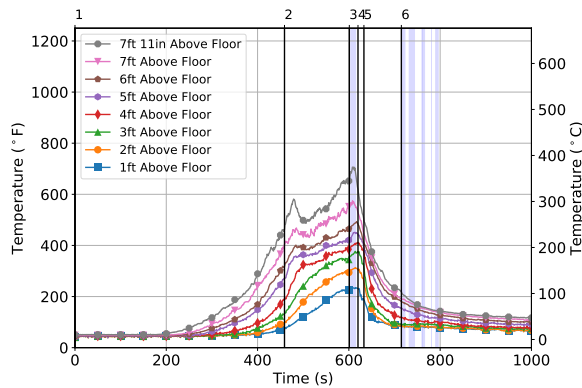

(b) Living Room Temperatures

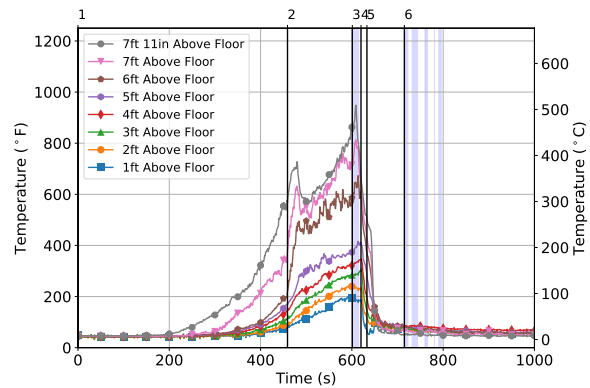

(c) Entryway Temperatures

Figure 3.250: Temperatures remote from the fire room on the fire floor for Experiment 20. Blue vertical bars indicate time and duration of water flow.

Remote temperatures on the floor above the fire room are presented in Figure 3.251. Hallway temperatures began increasing approximately 250 s post ignition, as hot gases rose to the second-floor. Temperatures peaked just after exterior water flow, reaching approximately 305 °F. Exterior water flow cooled fire room temperatures, causing a reduction in temperatures in the hallway. Temperatures returned to near ambient conditions after interior water flow.

Temperatures within bedrooms 1 and 3 (see Figures 3.251b and 3.251c, respectively) behaved similarly, as both bedroom doors were open. Temperatures began increasing prior to flashover, approximately 300 s post ignition. Temperatures reached a peak between 230 °F and 235 °F after exterior suppression. Temperatures then decreased. Bedroom 2 temperatures behaved differently than bedrooms 1 and 3, as the door to bedroom 2 was closed to the experimental volume. Temperature within this closed bedroom remained near ambient, reaching a maximum of approximately 65 °F.

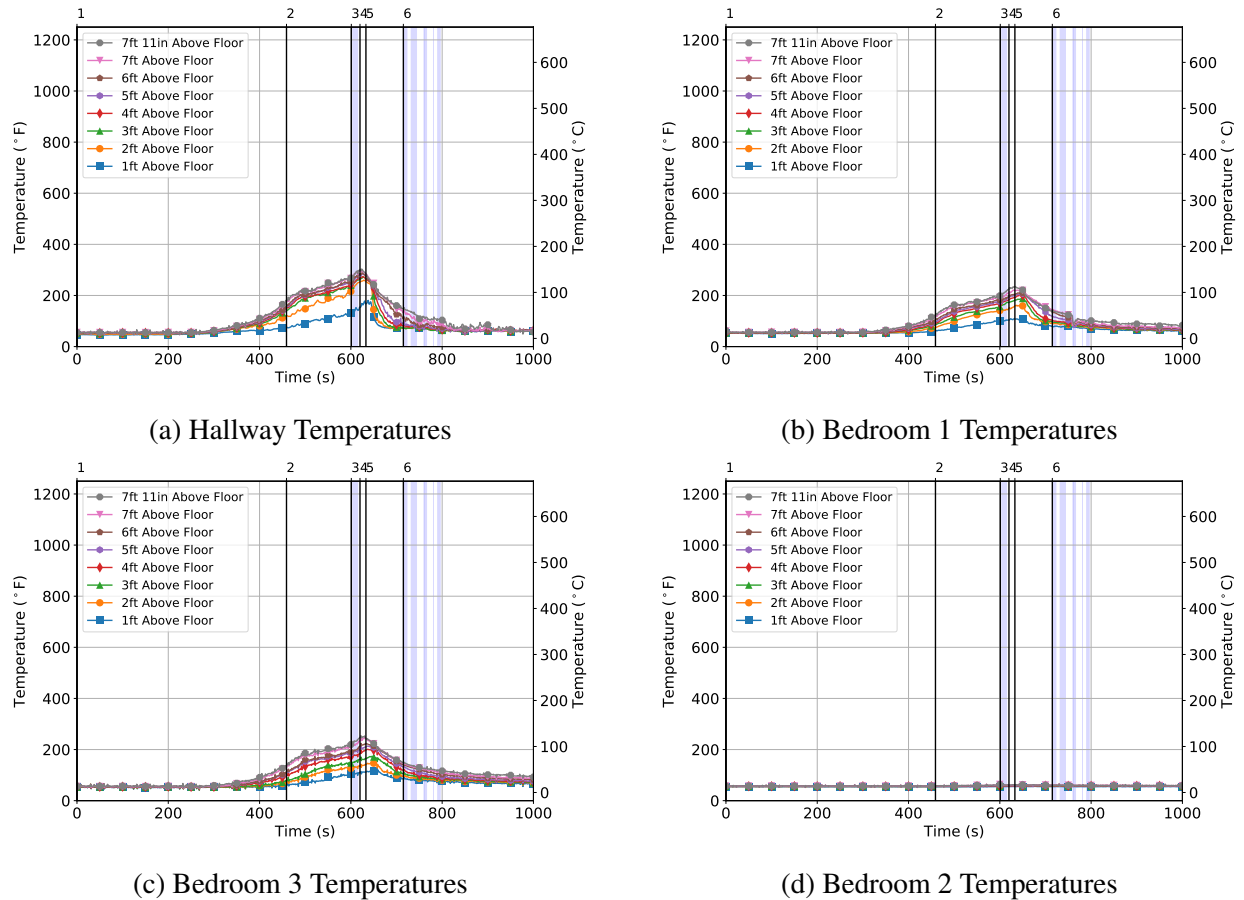

	Action/Event	Time (s)
1	Ignition	0
2	Flashover	459
3	Exterior Flow	601
4	Front Door Open	620
5	PPV Fan Turned In	633
6	Interior Flow	715

Figure 3.251: Remote temperatures above the fire floor for Experiment 20. Blue vertical bars indicate time and duration of water flow.

Prior to fire department intervention, the only openings into and out of the kitchen were the two windows on side C and the doorway leading to the dining room. The growth of the fire in the kitchen created changes in pressure, resulting in bi-directional flows throughout these openings. The pressure data from the fire room is presented in Figure 3.252. Kitchen pressures began to change approximately 100 s post ignition. Pressure at the 7 ft elevation increased as hot gases accumulated at the ceiling of the kitchen. Pressures at the 4 ft and 1 ft elevations decreased as the fire entrained cool air to sustain combustion. Flashover occurred 459 s post ignition, causing the pressure at the 1 ft elevation to remain constant and the pressure at the 4 ft elevation to decrease steadily. After interior water flow, pressures return to ambient levels.

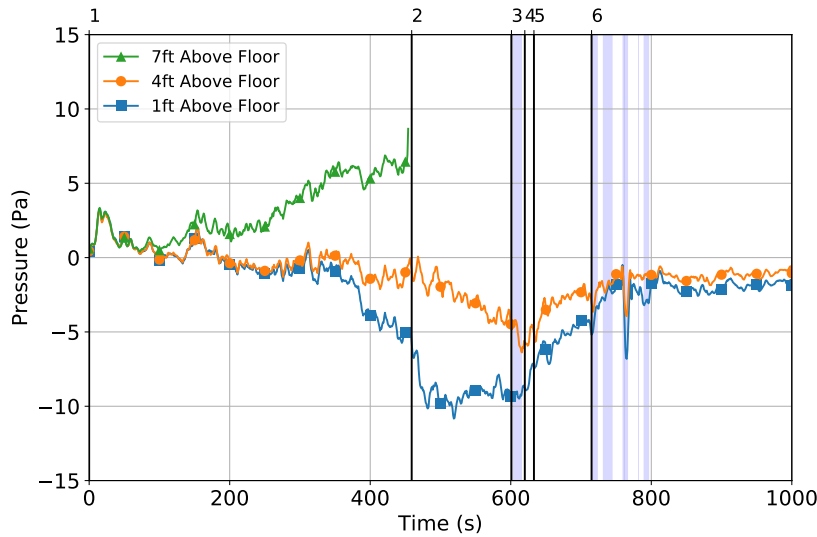

	Action/Event	Time (s)
1	Ignition	0
2	Flashover	459
3	Exterior Flow	601
4	Front Door Open	620
5	PPV Fan Turned In	633
6	Interior Flow	715

Figure 3.252: Pressures in the fire room (kitchen) for Experiment 20. The pressure at the 7 ft elevation sensor failed after flashover. Blue vertical bars indicate time and duration of water flow.

Pressures remote from the fire room on the fire floor were monitored in the dining room; that data is presented in Figure 3.253. Dining room pressures began to change around 200 s post ignition, corresponding to the initial temperature increase within this space. Pressure at the 7 ft elevation increased from ambient pressure as hot gases accumulated near the ceiling. Pressures at the 4 ft and 1 ft elevations decreased from ambient pressure as the fire entrained air to sustain combustion. Pressure at all three elevations returned to ambient pressure after the PPV fan was turned into position.

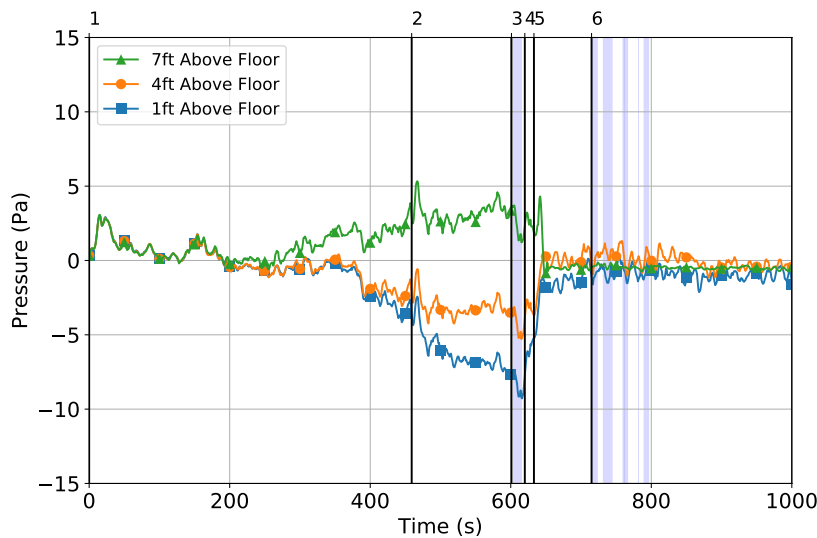

	Action/Event	Time (s)
1	Ignition	0
2	Flashover	459
3	Exterior Flow	601
4	Front Door Open	620
5	PPV Fan Turned In	633
6	Interior Flow	715

Figure 3.253: Dining room pressures during Experiment 20. Blue vertical bars indicate time and duration of water flow.

Second-floor remote pressures are presented in Figure 3.254. Pressures within spaces open to the experimental volume of the structure, hallway (see Figure 3.254a), bedroom 1 (see Figure 3.254b), and bedroom 3 (see Figure 3.254c), behaved similarly. Positive pressure was indicated at all three elevations throughout the duration of the test. The pressure began to increase around 250 s post ignition. Pressure remained constant until after exterior water flow.

Although the pressure within these spaces all began to increase approximately 300 s post ignition, the magnitudes of the increase were different due to the distance from the fire and the pathway to the pressure measurement location. The hallway pressure reached a peak of 13.4 Pa, while bedroom 1 and bedroom 3 reached peaks of 10.1 and 7.2 Pa, respectively. The spaces on the second-floor became positively pressurized as hot gases accumulated at the highest elevation of the house. Bedroom 2 also became positively pressurized, but only reached a magnitude of 1.8 Pa, as that room was isolated from the flow path because of a closed door.

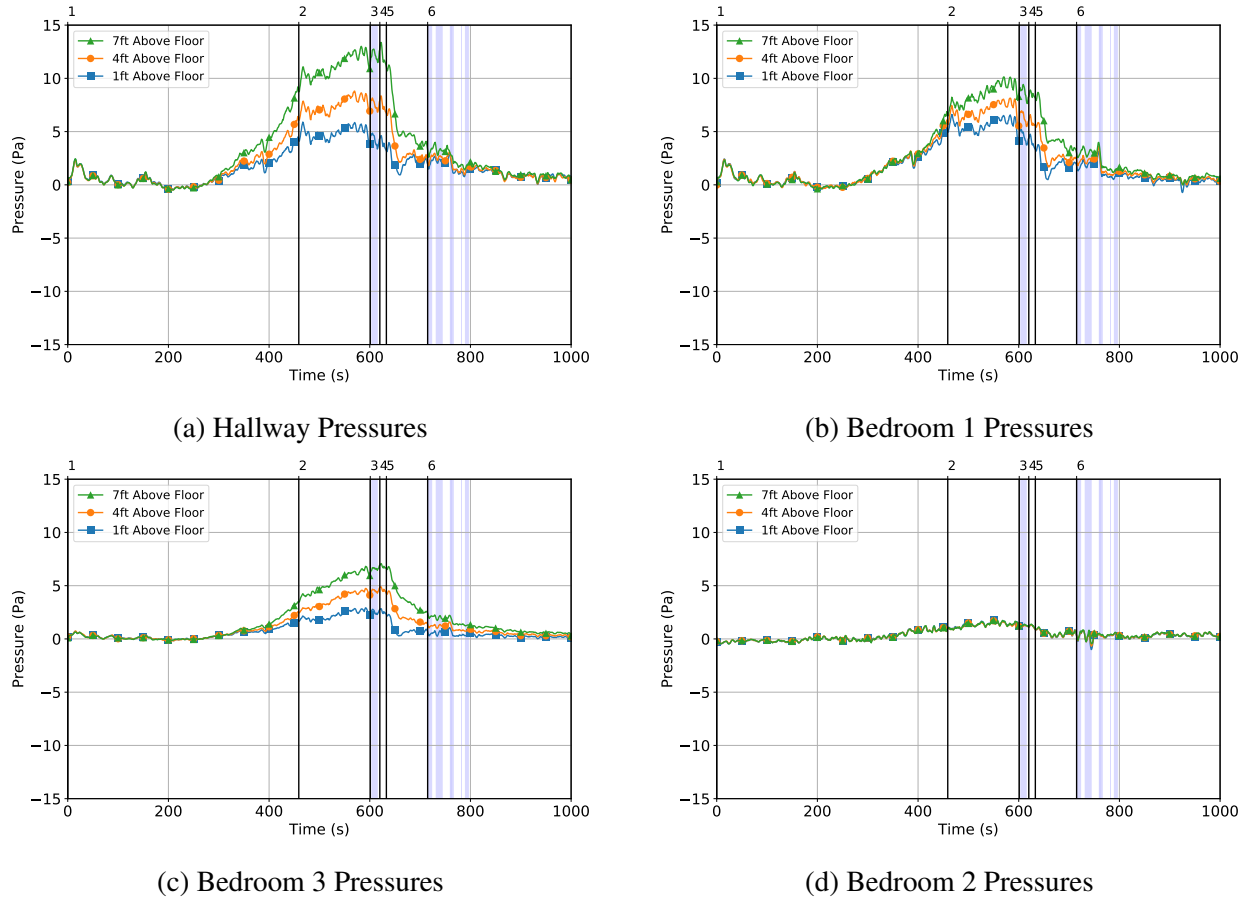

	Action/Event	Time (s)
1	Ignition	0
2	Flashover	459
3	Exterior Flow	601
4	Front Door Open	620
5	PPV Fan Turned In	633
6	Interior Flow	715

Figure 3.254: Remote pressures on the second floor for Experiment 20. Blue vertical bars indicate time and duration of water flow.

The differences in pressure throughout the structure established a bi-directional flow throughout openings. The changes in flow before and after fire department intervention are presented in Figure 3.255. Prior to fire department intervention the only openings in the kitchen were the doorway into the dining room and the windows located on side C and side D. Pressure at the 7 ft elevation in the fire room was greater than the pressure at the 7 ft elevation in the dining room. Pressure at the 1 ft elevation in the fire room was less than the pressure at the 1 ft elevation in the dining room. The gradient in pressure between the fire room and dining room promoted the exhaust of hot gases and entrainment of cool air out of and into the fire room, respectively (see Figure 3.255a). Entrainment of air was increased from the front door and exhaust of gases was increased through the windows

(see Figure 3.255b). After the fan was turned into place, air was forced into the structure, blocking most exhaust from exiting through the front door (see Figure 3.255c). This caused more exhaust to exit the structure through the fire room windows.

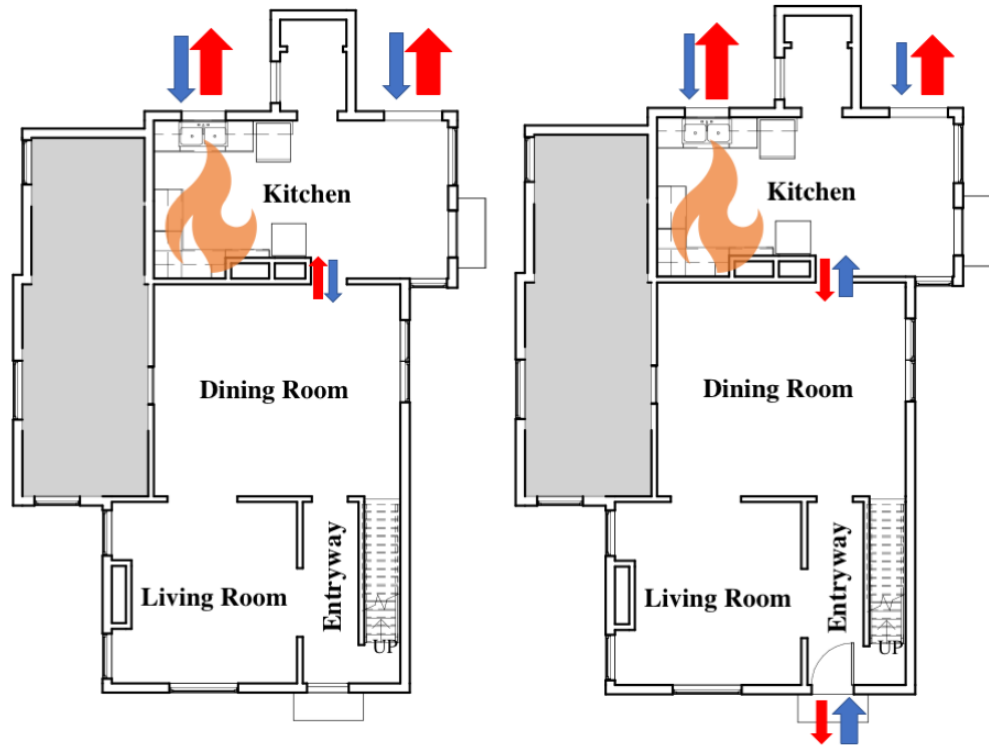

(a) Prior to Front Door Opened

(b) After Front Door Opened

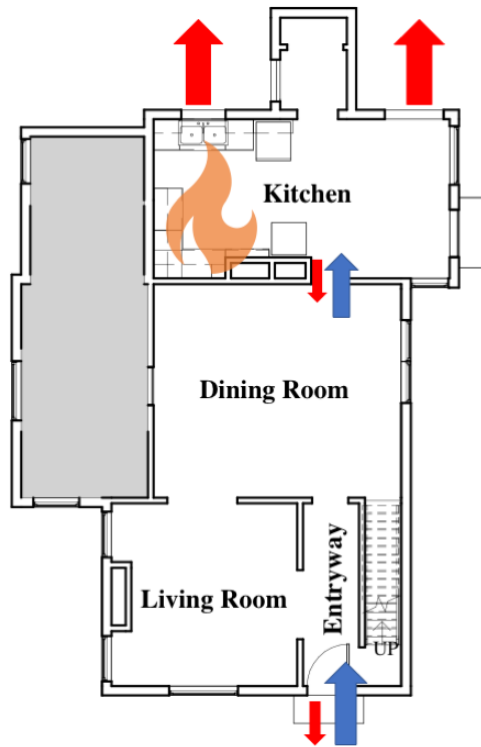

(c) After PPV

Figure 3.255: Changes in flow path for Experiment 20. Red arrows indicate flow out of the compartment, blue arrows indicate entrainment into the compartment, and the sizes of the arrows indicate the relative magnitude of the flow through each opening.

Heat flux was recorded at two locations, the dining room and hallway for Experiment 20. The dining room location monitored heat flux at a 1 ft elevation and the second floor hallway location monitored heat flux at the 1 ft and 3 ft elevations. The data recorded for both locations are presented in Figure 3.256. The dining room location on the first-floor experienced an increase in heat flux approximately 300 s post ignition. This corresponded to the ignition of the paper towel rolls on top of the fridge. At flashover 469 s post ignition, heat flux at this location peaked. Immediately after flashover, the heat flux decreased but it increased again approximately 500 s post ignition. This corresponded to constant flames from the side C window nearest side D. The heat flux at the dining room location returned to ambient after exterior water flow.

The hallway location on the second-floor experienced an increase in heat flux just prior to flashover at the 3 ft elevation. Post-flashover heat flux for the 3 ft elevation remained constant while the 1 ft elevation increased, peaking when the front door was opened. Both elevations returned to ambient just after the PPV fan was turned into position.

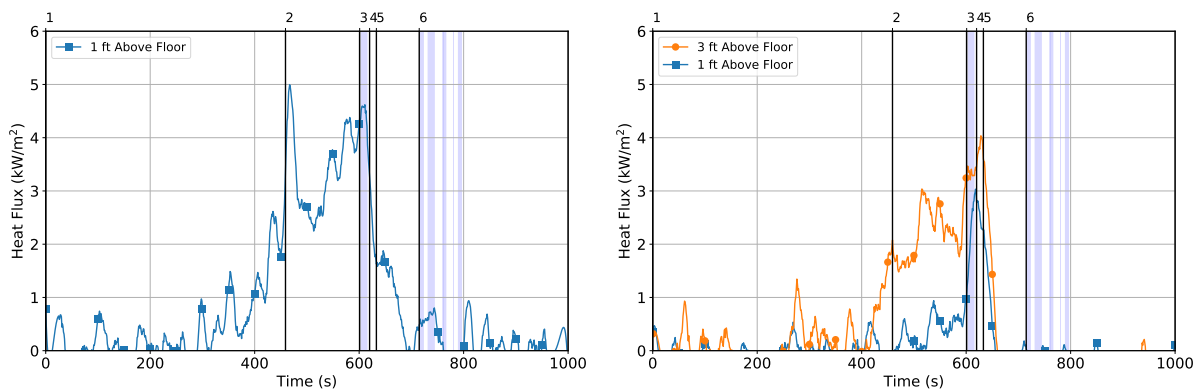

(a) Dining Room Heat Flux

(b) Second Floor Hallway Heat Fluxes

Action/Event	Time (s)	
1	Ignition	0
2	Flashover	459
3	Exterior Flow	601
4	Front Door Open	620
5	PPV Fan Turned In	633
6	Interior Flow	715

Figure 3.256: Heat flux at remote locations for Experiment 20. Blue vertical bars indicate time and duration of water flow.

The aforementioned locations also monitored gas concentrations of CO, CO₂, and O₂. The dining room location monitored gas concentrations at 1 ft above the floor, while the second floor hallway location monitored gas concentrations at 1 ft and 3 ft above the floor. Gas concentration data is presented in Figure 3.257. The dining room location did not witness a change in gas concentration until after flashover occurred, approximately 500 s post ignition. As O₂ concentration decreased, CO and CO₂ concentrations increased. The peak gas concentration occurred 660 s post ignition,

after exterior flow and ventilation occurred. Immediately following the peak, gas concentration returned to ambient just prior to interior water flow.

The location on the second level of the structure decreased in O_2 as an increase in CO and CO_2 was recorded approximately 300 s post ignition. Prior to the first fire department intervention of exterior water flow, the O_2 concentration at 3 ft was 9%, the CO concentration was 3%, and the CO_2 was 10%. The 1 ft elevation gas concentrations were 13%, 2%, and 7%, respectively. O_2 , CO, and CO_2 conditions in the second floor hallway began to improve just after exterior suppression and ventilation occurred, approximately 650 s post ignition.

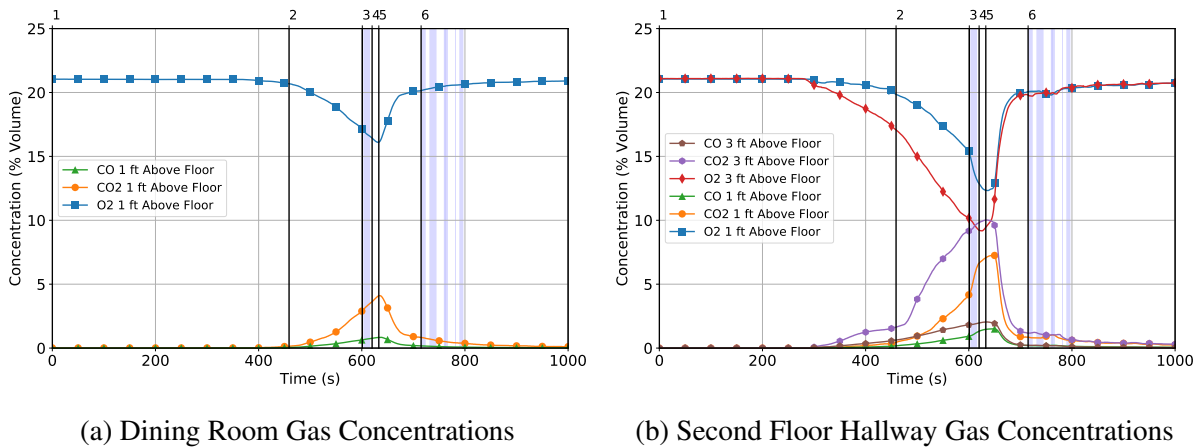

	Action/Event	Time (s)
1	Ignition	0
2	Flashover	459
3	Exterior Flow	601
4	Front Door Open	620
5	PPV Fan Turned In	633
6	Interior Flow	715

Figure 3.257: Gas concentrations at remote locations for Experiment 20. Blue vertical bars indicate time and duration of water flow.

4 Discussion

4.1 Exposure Analysis

The following analysis will allow the reader to assess the ventilation and suppression tactics of experiments within each of the six coordination methods for their impact on both occupant and suppression crew exposures. The data are used to assess the exposure to potentially trapped occupants and to the suppression crew firefighters during this experimental series. Assessment of the hazard to potential occupants considered both thermal and toxic exposures. Thermal exposure was assessed through the use of a pig skin model, accompanied by local temperature and heat flux measurements. Toxic exposure was assessed using local gas concentration measurements to compute the fractional effective dose (FED) [13]. Thermal exposures to firefighters were evaluated using thermal operating classes, which characterize firefighter exposures by heat flux and temperature.

4.1.1 Occupant Gas Exposure

Toxic exposure to potential occupants is estimated by the fractional effective dose (FED) method, which uses the select measured gas concentrations to calculate the time-dependent exposure of the occupant to toxic gases. Tenability analyses are typically incorporated into building design to estimate the time at which an occupant would no longer be able to affect their own rescue from a fire of a given size. In practice, however, even occupants who have met or exceeded the criteria for incapacitation may be able to survive their exposures if rapidly located, removed, and provided appropriate medical attention. For this reason, FED values can be used to compare the effects of firefighting interventions, but should not necessarily be employed as a predictor of lethality.

FED can be used to describe the portion of the population at which conditions become untenable. While a detailed description of the mathematical relationship is beyond the scope of this report, FED is related to the probability of the conditions being non-tenable for a certain percentage of the population through a lognormal distribution. For example, an FED of 0.3 is the criterion used to determine incapacitation for susceptible individuals (young children, elderly, and/or unhealthy occupants) and corresponds to untenability for 11% of the population. An FED of 1.0 is the value at which 50% of the population would experience untenable conditions, and an FED of 3.0 is the value at which 89% of the population would experience untenable conditions. The FED equation for toxic exposure can include a number of products of combustion, but these experiments focused on the most common gases produced at high concentrations during residential structure fires. In this case, the general N-gas equation can be simplified to include the following [13]:

$$FED_{toxic} = (FED_{CO} * HV_{CO_2}) + FED_{O_2} \quad (4.1)$$

In Equation 4.1, FED_{CO} and FED_{O_2} are the doses for carbon monoxide inhalation (CO) and low oxygen (O_2) resulting in hypoxia, respectively; each a function of time. The expression for FED_{CO} is shown in Equation 4.2:

$$FED_{CO}(t) = \int_0^t 3.317 * 10^{-5} [\phi_{CO}]^{1.036} (V/D) dt \quad (4.2)$$

where ϕ is the CO concentration in parts per million, dt is the time step, V is the volume of air breathed each minute, in liters, and D is the exposure dose, in percent carboxyhemoglobin (% COHb), required for incapacitation.

Values of V and D vary depending on the level of work being conducted by the subject. The default case is often taken to be light work (e.g. crawling to evacuate a structure), which corresponds to $D = 30\%$ COHb and $V = 25$ L/min. The uptake rate of CO and other products of combustion can vary considerably with V , and is dependent on a number of factors including hyperventilation induced by exposure to CO_2 . This increase in respiration rate due to CO_2 inhalation is accounted for in Equation 4.1 by the hyperventilation factor. This factor, HV_{CO_2} , is defined in Equation 4.3:

$$HV_{CO_2}(t) = \exp\left(\frac{0.1903(\exp(\phi_{CO_2})) + 2.0004}{7.1}\right) \quad (4.3)$$

where ϕ_{CO_2} is the mole fraction of CO_2 . Lastly, the fraction of an incapacitating dose due to low oxygen hypoxia, FED_{O_2} , is calculated by:

$$FED_{O_2}(t) = \int_0^t \frac{dt}{\exp[8.13 - 0.54(20.9 - C_{O_2}(t))]} \quad (4.4)$$

where dt is the time step and C_{O_2} is the O_2 concentration (volume percent).

Again, it is important to note that the threshold criteria for untenability ($FED = 0.3$, $FED = 1.0$, and $FED = 3.0$) predict the onset of incapacitation, not lethality. CO intoxication is driven primarily by the carboxyhemoglobin concentration in the bloodstream. Hemoglobin has a higher affinity for carbon monoxide than oxygen, so high COHb levels have an asphyxiating effect on the body. Based on work published by Purser in *Fire Toxicity*, incapacitating levels of COHb in the bloodstream are between 30% and 40% for the majority of the population, although susceptible populations may experience loss of consciousness at levels as low as 5% [14]. It is important to recognize that incapacitating levels of COHb have been found in surviving fire victims [13]. Active subjects are typically more severely affected by COHb concentrations than sleeping subjects. Lastly, median COHb levels of 50% are considered to be the threshold for lethality [14].

Gas concentrations and the resultant FEDs varied considerably among the 20 experiments prior to fire department intervention, and in particular among the different structures utilized in this study. Thus, it can also be useful to consider the rate of change of the FED, or the fractional effective

rate (FER). The FER can be used to assess the rate at which the exposure to a potential occupant would be increasing or decreasing. The FED itself can only increase or remain stagnant, it can never decrease, but a decreasing FER would indicate that an intervention is improving conditions. Additionally, the analysis considers the time from fire department intervention (either the opening of the front door or exterior water flow) until the CO concentration drops below 0.12% (1200 ppm), which is the threshold for immediately dangerous to life and health (IDLH) conditions. This timeline provides additional insight into the effectiveness of different coordination tactics at reducing toxic gas concentrations at the occupant tenability assessment locations.

4.1.2 Occupant Thermal Exposure

To estimate the potential for thermal injury at each occupant tenability assessment location, a skin burn evaluation model described by Traina et al. was used [15]. This model is constructed with pig (porcine) skin samples (a surrogate for the epidermis and dermis of human skin) placed on an ethylene propylene diene monomer (EPDM) slab (a surrogate for the subcutaneous fat layer). Temperature was measured on the exposed surface and between the bottom of the porcine sample and EPDM slab for each sample. Additionally, air temperature surrounding the samples and the temperature of the water bath were collected throughout each fire scenario. For these experiments, the surface and subdermal temperatures were averaged across the number of samples at each occupant location. The peak temperature and time elapsed until the temperatures exceeded 111 °F (44 °C) measured by the surface and subdermal thermocouples were considered.

The criterion of 111 °F (44 °C) originates from experiments with both humans and pigs conducted by Moritz and Henriques in the 1940's [16, 17]. Their research found that, while duration dependent, irreversible damage can occur to the epidermis when the surface of skin reaches 111 °F (44 °C). As the surface temperature rises above this value, the time to damage is reduced. In the 1950's, Moritz and Henriques' work was built upon by Stoll and Green [18] who found that as long as the surface temperature of the skins remains at or above 111 °F (44 °C), damage continues. Burn injury is a function of time and temperature.

Based on this prior research and more recent work by Traina et al., for experiments in which only the average surface temperature of samples exceed 111 °F (44 °C), a superficial or partial thickness burn is considered to occur. For experiments in which both the average surface and subdermal temperatures exceed 111 °F (44 °C), a deeper partial thickness or full thickness burn is considered to occur [15].

The skin burn model used in these experiments is intended to compare relative differences between the studied locations within a structure, and the change in ambient and surface temperatures that result from the employed suppression and ventilation tactics. The model used does not include the effects of sweat, perfusion, or presence of clothing, which would affect the heat transfer through the skin model.

4.1.3 Firefighter Thermal Exposure

Helmets for the suppression crew firefighter on the nozzle and officer were equipped with a thermocouple and heat flux gauges installed in the vertical and horizontal directions (orientations based on the helmet sitting on its brim on flat ground). The total energy exposure was calculated by numerically integrating the heat flux with respect to time. By finding the area under the curve for the heat flux as a function of time, the total exposure can be calculated.

Thermal exposure to firefighters is likely to vary with job assignment on the fireground. This analysis focuses on the thermal exposure to helmets worn by the nozzle and officer positions of the suppression crew. The exposure to the helmets of the nozzle and officer firefighters is likely to be different than the exposure to other parts of their PPE ensembles. Further, the height of the nozzle or officer firefighter, whether they are crawling or standing, and the direction in which they are looking at any given moment will influence the heat flux and temperatures measured over the course of the suppression period. The analysis conducted as part of this series of experiments primarily focuses on the peak and cumulative thermal exposure to the firefighters' helmets, and does not consider their location in the structure with respect to time. Additionally, it is possible that in some incidents those acting in other roles, such as firefighters searching for trapped occupants, may receive a higher thermal insult than the nozzle firefighter and suppression officer. Exposures such as these are outside the scope of this study.

In 1973, Utech suggested a combination of the local air temperature and the incident heat flux to estimate the components of radiative and convective heat transfer, respectively, to a firefighter. He used these two quantities to define three ranges of firefighters' operational thermal conditions: routine, ordinary, and emergency [19]. According to Utech, routine conditions are those with a surrounding temperature between 70 °F (20 °C) and 162 °F (72 °C) and an incident heat flux between 1 kW/m² and 2 kW/m². Utech maintained that these conditions translate approximately to ambient environments such as those experienced outside a typical structure fire to those that may be present during the overhaul phase of a fire. The thermal environment crosses into the ordinary operating range when temperatures were between 162 °F (72 °C) and 392 °F (200 °C) and heat fluxes between 2 kW/m² and 12 kW/m². Ordinary operating conditions include thermal environments that might be encountered next to a post-flashover room. According to Utech, firefighters are likely able to function under ordinary operating conditions from 10 min. to 20 min. at a time, or for the approximate working duration of an SCBA cylinder. Utech suggested that ordinary operating conditions were those typical of a house fire. Emergency operating conditions are present when heat flux exceeds 12 kW/m² and temperature is in excess of 392 °F (200 °C). These conditions resulted in increased risk for injury to a firefighter even when operating in PPE. Utech describes the emergency zone as one in which a firefighter's PPE is only be able to withstand an exposure on the order of a few seconds. The thresholds for the thermal operating classes are illustrated in Figure 4.1.

It is important that Utech's definition of the ordinary operating class is understood in the proper context. It is likely that a "typical fire" in the 1970's, when the thermal classes were developed, may be different than a fire with mostly synthetic fuels as is common almost 50 years later. The state of the art in personal protective equipment has advanced considerably since the 1970s, as has

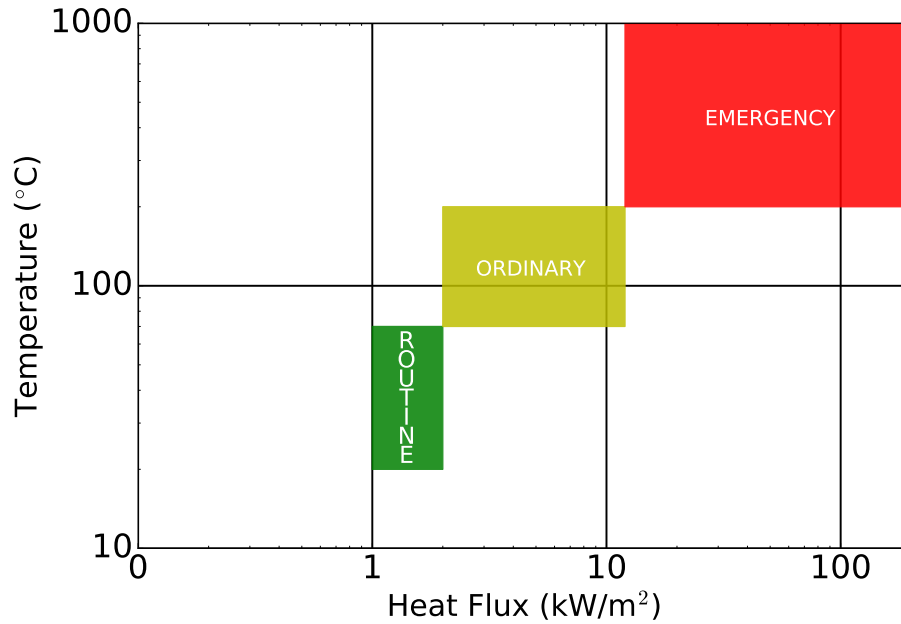

Figure 4.1: Thermal Operating Classes

the battery of performance standards for firefighter PPE [20, 21]. Research conducted on SCBA facepieces, which have been identified as one of the weak points of the firefighter PPE ensemble, has quantified the heat flux thresholds at which various forms of damage can manifest [22–24]. These thresholds are illustrated in Figure 4.2. The figure shows that while the most severe damage in a short period of time can be expected for heat flux exposures in the emergency operating class, hole formation, bubbling, and microcracking were observed for heat fluxes consistent with the ordinary operating class. Further, the 90th percentile of firefighter heat flux exposures for this series of experiments, measured by the heat flux helmets for the nozzle and officer positions and detailed in Sections 4.2 - 4.7, fall at different points in ordinary operating class. Because of the relatively large range of the ordinary operating class, which includes thresholds at which PPE damage can occur, this analysis considers the ordinary operating class in two sections—a lower portion from 2 kW/m² to 7 kW/m² and an upper portion from 7 kW/m² to 12 kW/m².

Madrzykowski [25] compiled previous research efforts to characterize the thermal operating environment of firefighters. The literature review highlighted that evaluating the operating environment of firefighters by pairing temperature and heat flux may not appropriately reflect the entire range of conditions encountered by firefighters. Additionally, the thermal conditions within a structure can rapidly change from environments where firefighters would be safe to conditions where firefighters would be in immediate danger. More sophisticated characterization of heat transfer through firefighter turnout gear and appropriate exposure thresholds for firefighter turnout gear are an area of ongoing research.

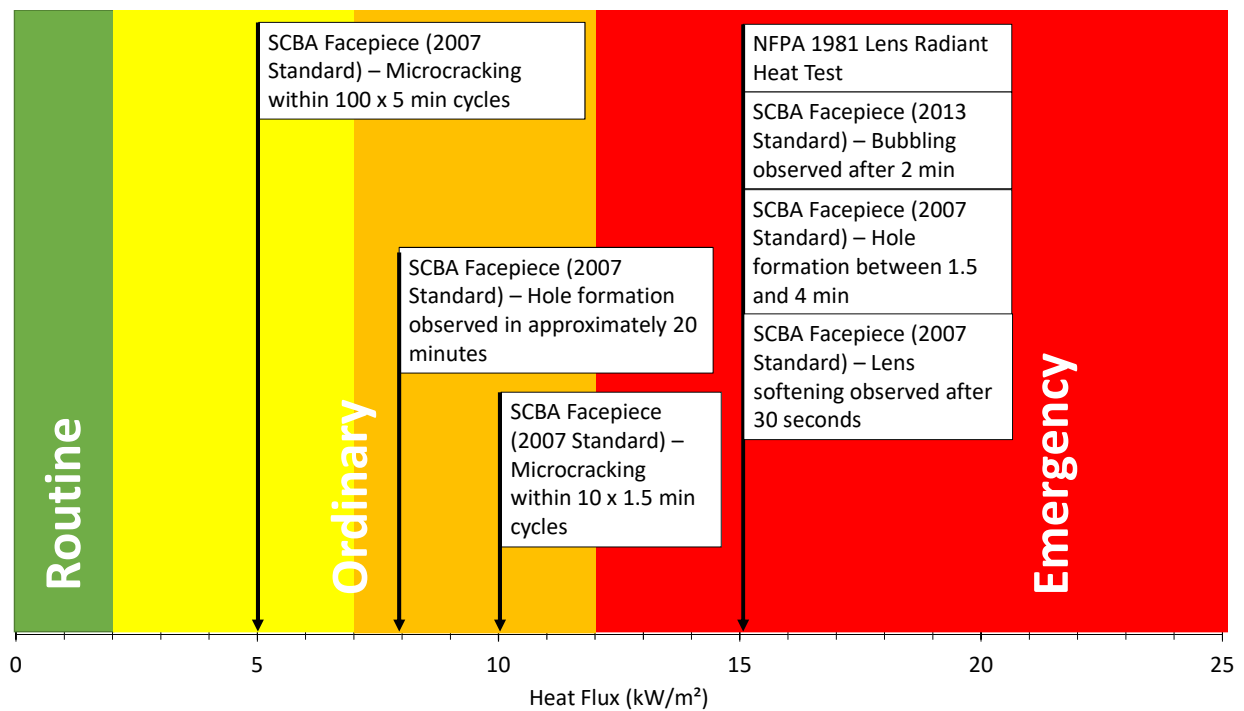

Figure 4.2: Comparison of Utech thermal operating classes with modern PPE performance limits from [21–24].

4.2 Method 1, Second Floor Bedroom Fire - Ventilation Post Interior Suppression

Six experiments were conducted using Method 1, which was designed to study the effectiveness of ventilation post suppression. The first experiment was the baseline case, where no ventilation occurred other than opening the front door to enable access of the suppression crew. For comparison, subsequent scenarios were conducted with additional ventilation tactics that included hydraulic ventilation, vertical ventilation, positive pressure ventilation, and door control. All experiments for Method 1 involved second-floor bedroom fires and were conducted in three separate structures. Experiments 1 and 3 were conducted at 1492 Dayton-Xenia Rd.; Experiments 2, 4, and 5 were conducted at 2401 Wapakoneta; and Experiment 6 was conducted at 1030 Hilltop Rd. As a result, differences in building geometry, including ceiling heights, interior volumes, and floor plans as well differences in event timings and weather conditions combine to limit some of the conclusions that can be drawn across the experimental set.

Previous research conducted by UL FSRI has included a series of experiments focused on ventilation tactics in the absence of suppression in residential fires [1–3]. These projects demonstrated that if a residential structure fire is ventilation-limited at the time of fire department arrival, uncoordinated ventilation can eventually result in fire growth. To counterbalance knowledge of the known risk of fire growth resulting from ventilation initiated prior to the start of suppression, Method 1 examined ventilation tactics initiated after suppression had started to take place in the fire room.

Experiments utilizing Method 1 began with a bedroom fire that was allowed to develop to a post-flashover state, after which the front door was opened. The timing to reach flashover, then initiate first intervention varied with each experiment and ranged from 5:30 to 8:31 (330 to 511 seconds) post-ignition. Approximately ten seconds later, the suppression team entered and began suppression actions. Table 4.1 lists the pertinent times in each experiment, including the opening of the front door, initial water in the bedroom, and relevant ventilation actions. The initial water application times ranged between 18 s and 38 s after the front door was open, while the fire room entry times ranged between 35 s and 102 s after the front door was open.

Table 4.1: Coordinated Method 1 Intervention Times

Intervention	Experiment					
	1	2	3	4	5	6
Ignition	00:00	00:00	00:00	00:00	00:00	00:00
Front Door Open	05:59	07:01	05:30	07:00	07:01	08:31
Suppression Crew Entered	06:10	07:11	05:40	07:09	07:12	08:41
Initial Water Into Bedroom	06:18	07:19	05:48	07:21	07:33	09:09
Hydraulic Ventilation Start	—	10:10	—	—	—	—
Hydraulic Ventilation Stop	—	10:50	—	—	—	—
Roof Vent Open	—	—	06:40	—	—	—
Ceiling Vent Open	—	—	06:51	—	—	—
Additional Horizontal Ventilation	—	—	—	07:49	—	—
Positive Pressure Ventilation	—	—	—	—	07:59	—
Door Control Initiated	—	—	—	—	—	08:41
Door Control Stopped	—	—	—	—	—	09:35

Table 4.2 summarizes the occupant locations for each of the six experiments, including whether the occupant tenability assessment package was located inside or remote from the flow path and the distance between the package and the fire room doorway. During each experiment, one of the occupant packages was located so that it was in or close to the inlet portion of the flow path that was created when the front door was opened, while the other occupant package was located in a room remote from the flow path. Both occupant tenability assessment package locations had skin burn packages and gas sample points 1 ft from the ground. In Experiments 1–5, the occupant package located in the flow path also included a 3 ft gas sample point, while in Experiment 6, both occupant locations had just the 1 ft location.

Table 4.2: Coordinated Method 1 Occupant Tenability Assessment Package Locations

Exp #	Location in Structure	Location with Respect to Flow Path	Distance (ft) from Fire Room
1	Bedroom 2	Remote	19.4
	Hallway	Inside	10.7
2	Bedroom 2	Remote	21.5
	Landing	Inside	7.7
3	Bedroom 2	Remote	26.7
	Hallway	Inside	21.1
4	Bedroom 1	Remote	21.8
	Landing	Inside	9.3
5	Bedroom 4	Remote	12.3
	Hallway	Inside	8.9
6	Flex Space	Remote	37.3
	Hallway	Inside	5.0

The average distance from the fire room to the remote occupant package was 23 ft \pm 8 ft (mean plus/minus standard deviation). For the occupant package inside the flow path, the average distance was shorter, at 10 ft \pm 5 ft. The standard deviation of one-third to one-half of the mean for the remote and inside locations, respectively, highlight the relative variability between each experiment. It is therefore important to recognize that exposures are a function of the tactics studied and the relative location in each experiment. Figure 4.3 summarizes the fire floor layouts for each experiment in Method 1.

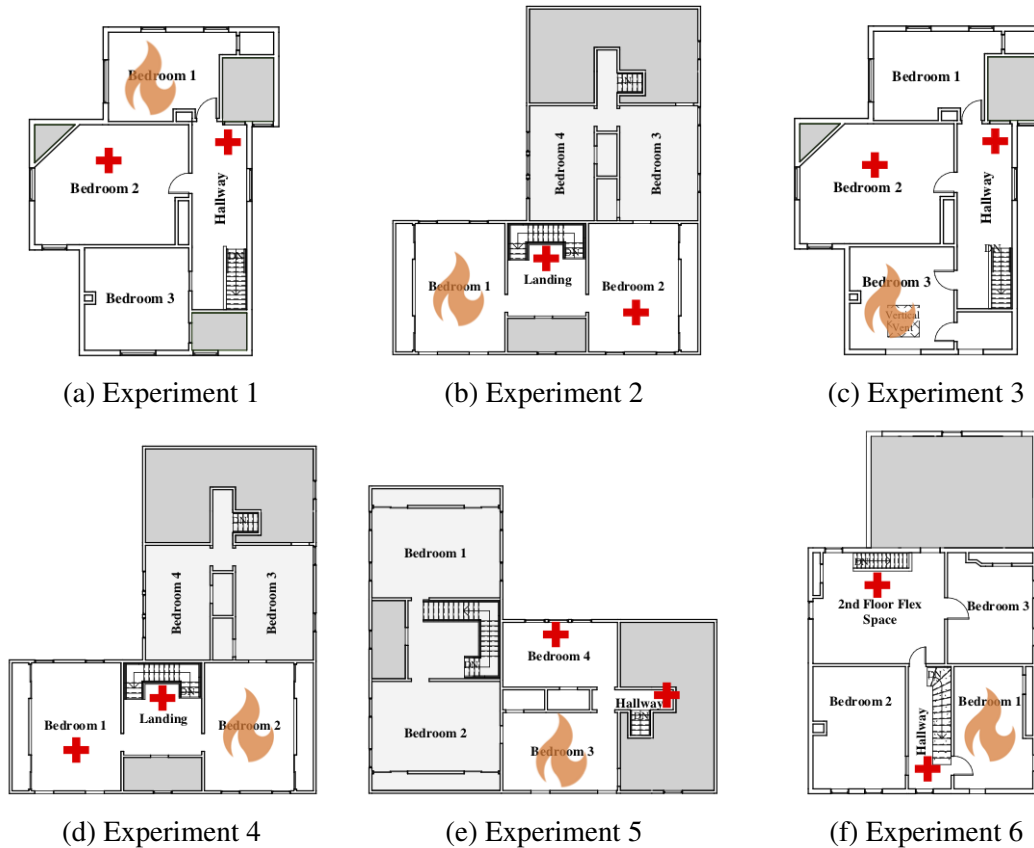

Figure 4.3: Fire floor layouts for acquired structures used in Method 1 experiments. The red crosses represent the approximate locations of the occupant assessment packages. The gray areas were isolated from the remainder of the structure and utilized as space for instrumentation.

4.2.1 Suppression and Ventilation Tactics

Suppression actions can be categorized based on relative location from the fire room: 1) suppression that occurred remote from the fire room, such as on the stairs or landing, and 2) suppression that occurred in the fire room doorway. The timing of water flows for each experiment are shown in Table 4.3. In Experiments 1–4, suppression actions conducted from the stairway and landing were most effective at reducing fire room temperatures. The layout of the floorplan and fire room for those experiments allowed water application into the fire room from the stairwell and landing. While the initial remote suppression actions reduced temperatures in the path of travel to the fire room in each case, the fire was not fully suppressed until there was water flow in the fire room doorway and within the fire room.

Table 4.3: Method 1 Tactic Duration and Times to Water Flow

	Experiment					
	1	2	3	4	5	6
Time from front door open to first water flow (s)	17	25	21	21	18	38
Time from front door open to flow in fire room doorway (s)	17	42	46	39	32	38*
Time from front door open to fire room entry (s)	35	47	102	47	50	69

* In Experiment 6, the first suppression action was at the fire room doorway.

To compare to impact of structure layout and the resulting effectiveness of suppression actions, consider Experiment 3 and Experiment 5. The transient nature of the remote suppression action can be seen in the example provided in Figure 4.4, from Experiment 3, where the suppression crew’s initial action occurred from the stairway, toward the fire room in bedroom 3. The 7 s stairway suppression action reduced temperatures in the fire room from above 1500 °F to between 850 °F and 550 °F. In the 19 s pause between stairway suppression and landing suppression actions, temperatures began to recover in upper region of the fire room while the remainder leveled off. The landing suppression further decreased fire room temperatures but cooling was limited by the inability to apply water to all of the burning items in the room. Temperatures remained steady as the vertical vent was completed. Temperatures within the fire room returned to pre-ignition conditions once the suppression crew entered the fire room. Simultaneous with the temperature decrease in the fire room, temperatures in the hallway decreased. Note: In Figure 4.4b the lack of impact on hallway temperature from the vertical ventilation.

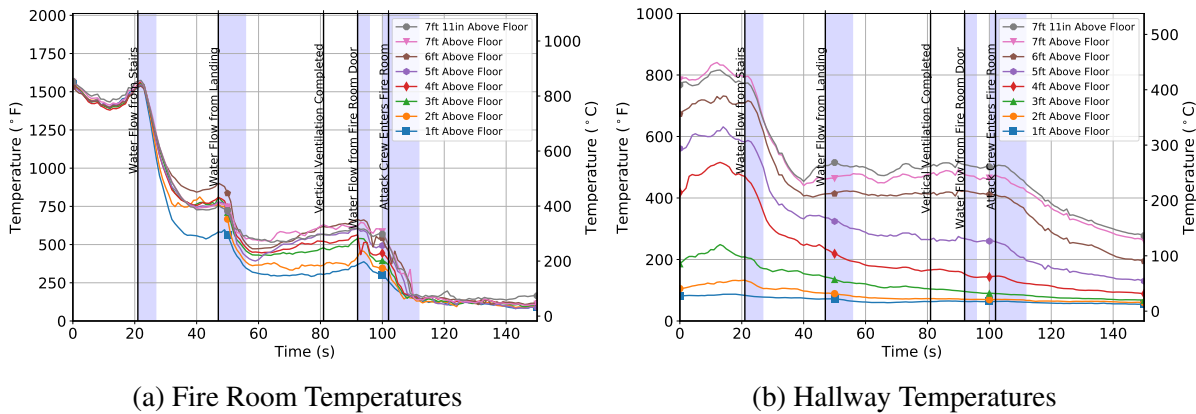

Figure 4.4: Effect of hallway, landing, doorway, and fire room suppression actions on fire room and hallway temperatures in Experiment 3. Time = 0 corresponds to the front door being opened and data is included for 150 s after fire department intervention.

In Experiment 5, the initial suppression action from the stairway was not effective at reducing the fire room temperatures, although it did provide local cooling in the hallway as the suppression crew advanced to the stairway landing (see Figure 4.5). Although this initial suppression action

reduced temperatures in the hallway, temperatures began to increase after water flow stopped as hot combustion gases flowed out of the fire room. Further suppression actions from the landing and fire room doorway also reduced temperatures, but they did not return to pre-ignition conditions until suppression crew advanced into the fire room to completely wet all surfaces. The effectiveness of suppression actions in Experiments 3 and 5 illustrate the importance of water application into the fire room. “Shut-down-and-move” suppression techniques with no ability to apply water into the fire room provided brief benefit in the local area of the suppression crew, but temperatures in both the fire room and remote areas rebounded or remained steady until the suppression crew began to effectively apply water within the fire room.

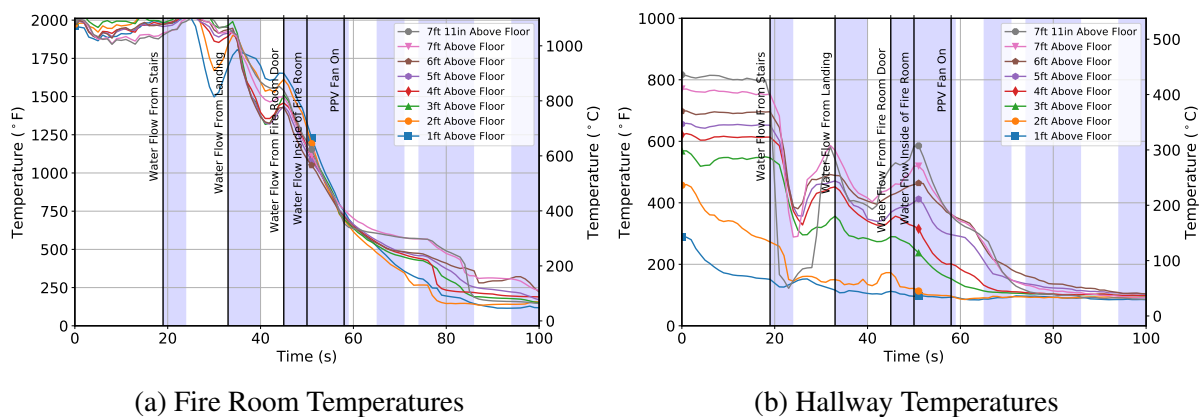

Figure 4.5: Effect of hallway, landing, doorway, and fire room suppression actions on fire room and hallway temperatures in Experiment 5. Time = 0 corresponds to the front door being opened and data is included for 150 s after fire department intervention.

In each of the six experiments, including the baseline case of Experiment 1 that had no additional post-suppression ventilation, a new flow path was established after the opening of the front door. An inlet was established at the front door with an efficient exhaust already established at the fire room windows. It is important to note that prior to the front door being opened, the fire room windows, though relatively inefficient, acted as both inlets and exhausts for fire room flow. For Experiments 1, 2, 3, 5, and 6 this initial ventilation/forced entry action resulted in a decrease in fire room temperatures as a result of the fresh air entrained through the front door displacing the hot combustion products that exhausted through the open fire room windows. This temperature decrease lasted on the order of 5-10 s before temperature began to increase as additional oxygen reached the fire room. The temperature rise in Experiment 6 was delayed by approximately 25 s compared to other Method 1 experiments as a result of door control. While fire room temperatures in Experiment 4 remained steady following the opening of the front door, temperatures on the landing and in the remote bedroom decreased due to air inflow into the structure.

While the fresh air provided by the open front door resulted in an eventual increase in temperatures, this ventilation action led to an improvement in the potentially incapacitating gas concentrations (increase in O_2 and a decrease in CO and CO_2 concentrations) at the occupant assessment locations located close to the inlet portion of the flow path. This improvement in conditions was observed

shortly after the opening of the front door, but became more pronounced following the initiation of suppression. In Experiments 1 and 3, the entrained air from opening the front door did not have as immediate of an effect at the hallway occupant location, located close to the inlet portion of the flow path until after suppression began.

The lack of additional ventilation in Experiment 1 was most apparent in the remote (bedroom 2) occupant location. Figure 4.6 compares the time between the front door opening and the time at which the CO concentrations dropped below 0.12% (1200 ppm) for each of the three occupant locations for the six Method 1 experiments. 0.12% (1200 ppm) is used as threshold as the CDC defines this to be the limit for an environment that is immediately dangerous to life or health concentrations (IDLH) [26]. Based on an expanded uncertainty of gas measurements of $\pm 12\%$ (see Section 2.3), the uncertainty bars in Figure 4.6 represent the time window at which the measured CO concentration dropped below 1344 ppm and 1056 ppm.

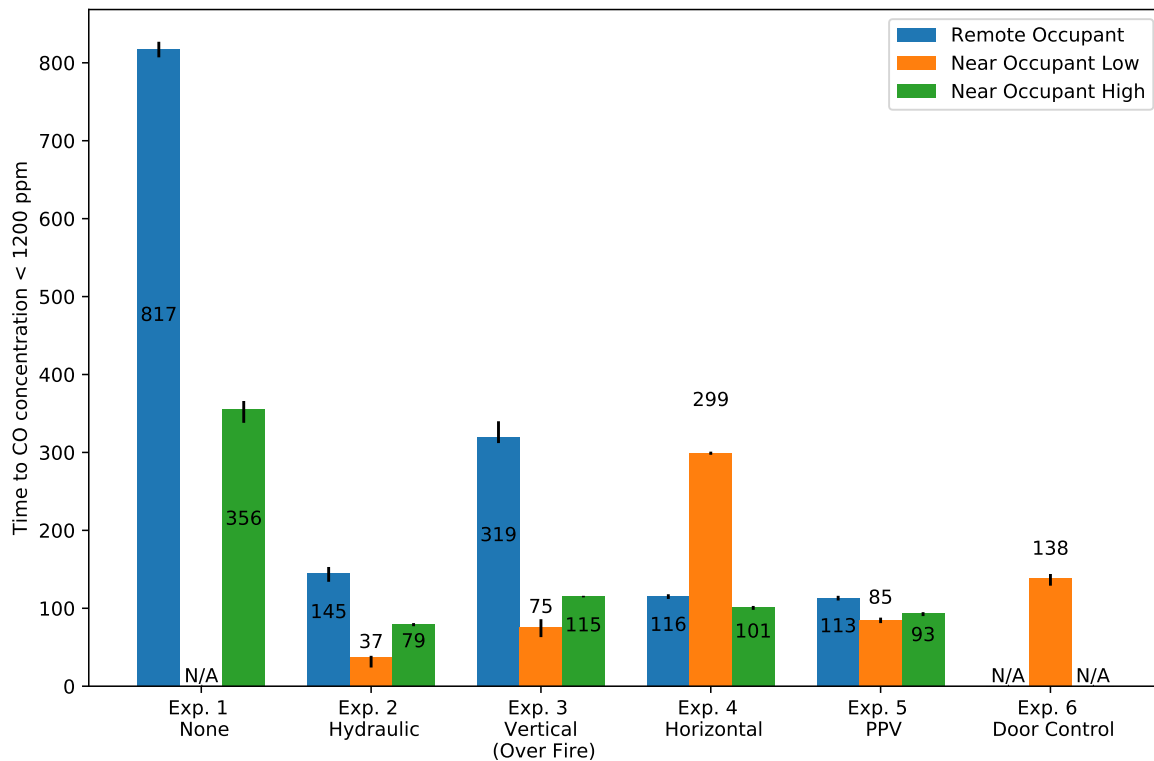

Figure 4.6: Time elapsed from the opening of the front door to the time at which the CO concentration at occupant locations dropped below 1200 ppm. Note: “N/A” indicates a sensor error or experiment in which the peak CO concentration was below the measurement error.

Gas concentrations in Experiment 1 took, on average, approximately twice as long to drop below the threshold for IDLH conditions than any of the other Method 1 experiments. For Experiments 2–6, the one distinct outlier was the remote occupant in bedroom 2 for Experiment 3 (see Figure 4.6). In Experiment 3, the vertical vent led to additional flow through the fire room, but had limited

impact on gas flow on the second-floor outside the fire room. This is because the occupant location in bedroom 2 was remote from the flow path, which is similar to the lack of flow in Experiment 1. Figure 4.7 shows the flow paths in Experiments 1 and 3 after the completion of ventilation. Although there is exchange of fresh air and products of combustion between bedroom 2 and the hallway (see Figure 4.7b), the majority of flow is directed toward the fire room.

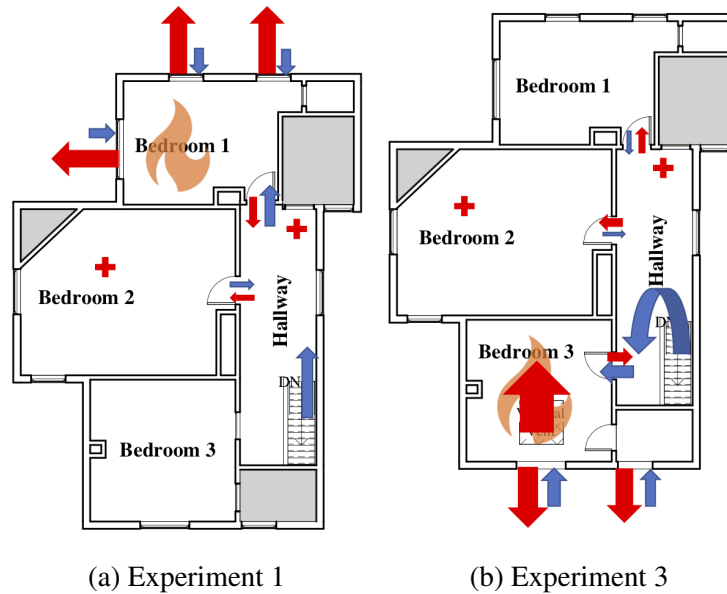

Figure 4.7: Comparison of post-ventilation flow paths at the comparable location in Experiments 1 and 3.

4.2.2 Occupant Tenability Estimate

Gas concentration data was collected for each of the three occupant locations for Experiments 1–5. In Experiment 6, the 3 ft sensor location in the flex space malfunctioned and data was not captured. The gas concentrations were used to compute the fractional effective dose (FED) and fractional effective rate (FER) for each experiment. The magnitude of the FEDs that were observed in the Method 1 experiments varied considerably which can be attributed to both the layout of the structure and the tactics employed. Occupant tenability was assessed by 1) the FED values at the time of the front door opening and 2) at the end of the experiment, 3) the time elapsed from the opening of the front door to the peak FER and 4) time required for the CO concentrations to drop below 0.12% or 1200 ppm (Table 4.4).

Table 4.4: Method 1 Occupant Tenability Estimate

Exp	Occupant Location	FED at Front Door Open	Final FED	Time* to Peak FER [s]	CO at Front Door Open [ppm]	Time* to CO < 1200 ppm [s]
1	Bedroom 2 1 ft	0	8.6	85	2900	817
	Hallway 3 ft	0	1.7	106	5400	356
2	Bedroom 2 1 ft	5.7	13.9	11	31800	145
	Landing Doorway 1 ft	0.4	0.6	2	5750	37
	Landing Doorway 3 ft	51	65.9	-	28800	79
3	Bedroom 2 1 ft	0	0.8	154	+	319
	Hallway 1 ft	0	0.3	33	+	75
	Hallway 3 ft	0.2	1.1	23	7500	115
4	Bedroom 1 1 ft	14.4	23.3	9	33800	116
	Landing 1 ft	0.1	0.5	49	1100	56
	Landing 3 ft	1	2.5	31	8000	101
5	Bedroom 4 1 ft	1.0	1.8	8	6100	113
	Hallway 1 ft	7.4	120.8	3	13300	85
	Hallway 3 ft	223.4	253.5	-	25400	93
6	Flex Space 1 ft	3.5	5.6	-	14700	138
	Hallway 1 ft	0	0	-	+	#

* Times are expressed as time elapsed after the initial fire department intervention (front door open)

- indicates peak FER occurred at front door open.

+ indicates CO concentrations below measurement error.

indicates CO did not increase beyond 1200 ppm.

For each of the experiments in Method 1, opening of the front door established a flow path from the front door to the fire room that eventually led to a peak in the rate of change of the fractional effective dose (FER). Essentially, at this point the FER reached a local maximum, after which the rate of toxic exposure decreased for the remainder of the experiment. It is important to recognize that the total fraction effective dose continued to increase. However, the time between opening the front door and this peak varied considerably. The time until this peak was longest in Experiment 1, where the 1 ft and 3 ft hallway FER did not reach a maximum until 60 s and 106 s after the front door was opened. In Experiments 2, 5, and 6, the FER began to decrease almost immediately after opening the front door at the occupant locations close to the inlet portion of the flow path. The fresh air entrained through the open door improved conditions for potential occupants at those locations and suppression was rapid enough to prevent fire growth due to the ventilation. In Experiments 3 and 4, the peak FER was observed after suppression began, suggesting that the ventilation action did not measurably impact tenability in the time between this action and water application.

The lack of ventilation in Experiment 1 resulted in gas concentrations that remained high for longer than the other experiments in Method 1; particularly, in the bedroom 2 location, where the FER remained elevated well after suppression had been completed in the fire room. Although the initial

FEDs at the time of intervention in Experiment 1 were relatively low (nearly zero), the FED at the end of the experiment exceeded the criteria for incapacitation at all three occupant locations. The lack of additional ventilation in the structure prevented an efficient exchange of gases in areas not in the flow path between the front door and fire room. The CO concentrations in Experiment 1 took longer to drop below 0.12% (1200 ppm) than any of the other Method 1 experiments.

Although the hallway FERs in Experiment 3 began to decrease (i.e., gas concentrations recovered toward ambient) following the stairway and landing suppression actions (see Figure 3.38a), the bedroom 2 occupant FER did not respond as rapidly, similar the response noted in Experiment 1. As this location was not in the flow path established from the front door to the fire room vents (windows and vertical vent), the FER continued to increase until after the suppression crew had entered the fire room for final suppression. The increase in FED from the time of intervention to the end of the experiment was less in Experiment 3 than Experiment 1.

Experiments 2, 4, and 5 exhibited higher peak 3 ft. CO and CO₂ concentrations and reduced O₂ concentrations (described in Sections 3.2, 3.4, and 3.5) than the other Method 1 experiments as reflected by the high FEDs at the time of intervention in Table 4.4. All of these experiments were conducted in the structure at 2401 Wapakoneta Ave. It is possible that the high gas concentrations were a result of a construction feature of the building, such as the wallpaper, carpet, or varnish that was used. Despite the high FEDs and FER that resulted from the more severe initial exposure, it is important to note that the FER in each of these experiments had decreased substantially by the time that the suppression crew had entered the fire room. Note: Despite the high CO concentrations at the time of intervention, the time for CO concentration in Experiment 4 to drop below the IDLH level (see Table 4.4) was still less than the experiment without additional ventilation.

In Experiments 2 and 4, the landing occupant at 1 ft had the lowest total FED at the end of the experiment due to its location next to the balcony overlooking the stairway. Over the course of the experiment, fresh air from the first-floor (later supplied from the open front door) traveled across this location, which kept gas concentrations near ambient, and the corresponding FEDs, low. In Experiments 2 and 4, the FED at the end of the experiment did not exceed the criteria for incapacitation for 50% of the population.

A similar phenomenon was observed for the hallway occupant in Experiment 6. The gas concentrations remained low for the majority of the experiment, due to air flow across the sensor location, resulting in a negligible FED by the end of the experiment. Although the 1 ft occupant location in the flex space had already exceeded the criteria for incapacitation by the time the front door had been opened in Experiment 6, the fresh air afforded by the opening of the front door decreased the FER almost immediately.

In addition to an examination on gas exposure, skin burn assessment packages were included at each occupant location. Table 4.5 lists the peak surface and subdermal temperatures and time from ignition until the temperature exceeded 111 °F (44 °C), the minimum threshold for thermal injury [15]. In general, the skin burn assessment packages that were closest to the fire room doorway displayed the highest peak surface and subdermal temperatures.

Table 4.5: Coordinated Method 1 Pig Skin Temperatures

Exp	Location	Surface Temperature		Subdermal Temperature	
		Time to 111 °F [s]	Peak [°F]	Time to 111 °F [s]	Peak [°F]
1	Bedroom 2	-	95	-	95
	Hallway	250	200	307	121
2	Bedroom 2	334	133	-	108
	Landing	263	188	399	116
3	Bedroom 2	-	79	-	83
	Hallway	287	112	-	101
4	Bedroom 1	340	126	-	110
	Landing	210	172	329	116
5	Bedroom 4	243	170	406	125
	Hallway	280	156	-	110
6	Flex Space	490	114	-	101
	Hallway	292	146	-	110

- indicates value not reached during experiment

The highest peak surface and subdermal temperatures were measured in the occupant tenability assessment packages that were located within approximately 15 ft from the fire room doorway. Within this distance, all of the peak surface temperatures exceeded 111 °F (44 °C) and many of the peak subdermal temperatures exceeded 111 °F (44 °C). These temperatures suggest the occupants at these locations would be more likely to sustain deeper thickness burns in a shorter period of time.

As distance from the fire room increased, the peak surface temperatures decreased. The occupant packages in bedroom 2 for Experiments 1 and 3 were at the only locations that did not exceed a surface temperature of 111 °F (44 °C) during Method 1 experiments. The only remote occupant package to exhibit a peak temperature in excess of 111 °F (44 °C) was the remote bedroom occupant in Experiment 5. Experiment 5 exhibited some of the highest peak surface temperatures of any of the Method 1 experiments. Whereas in most experiments, the hallway/landing occupant package experienced a higher thermal insult than the remote occupant location, in Experiment 5 the peak temperatures were comparable. This is partially because the distance from the fire room doorway to each occupant tenability assessment package was comparable, and partially because of the high temperatures measured close to the floor that were discussed in Section 3.5 (1 ft temperatures in excess of 200 °F).

4.2.3 Firefighter Helmet Thermal Exposure

Helmet data was recorded for nozzle firefighter in Experiments 3, 4, and 6, and suppression crew officer for Experiments 2, 3, 5, and 6. In Experiments 3 and 5, heat flux data was collected, but temperature was not. The results of measurements collected from entry to exit of the structure, including the peak temperatures and heat fluxes, the temperature average (μ) and standard deviation (σ), and the total energy exposure in both the horizontal and vertical directions, are shown in Table 4.6.

The two experiments in which data was collected for both the nozzle and officer positions showed that in general, the nozzle firefighter experienced higher peak heat fluxes and total energy exposures. The peak heat flux recorded by the nozzle firefighter in Experiment 3 was 11 kW/m², compared to 8 kW/m² for the engine officer. In Experiment 6, the nozzle firefighter experienced a peak heat flux of 16 kW/m², a peak total energy exposure of 340 kJ/m², and a peak temperature of 442 °F (228 °C), while the engine officer experienced a peak heat flux of 10 kW/m², a total peak energy exposure of 125 kJ/m², and a peak temperature of 515 °F (268 °C). A key point is that heat flux was higher for the nozzle firefighter, but the peak and average temperature were higher for the engine officer, an indication that the heat and temperature exposures are not necessarily coupled.

Table 4.6: Thermal Exposure to Nozzle and Officer Firefighter Helmets – Method 1

Nozzle Firefighter						
Exp / Ventilation	Temperature [°F]		Vertical Heat Flux [kW/m ²] [kJ/m ²]		Horizontal Heat Flux [kW/m ²] [kJ/m ²]	
	$\mu \pm \sigma$	Peak	Peak	Total Energy	Peak	Total Energy
3 / Vertical	-	-	11	411	10	331
4 / Horizontal	147 ± 81	381	27	286	15	242
6 / Door Control	255 ± 100	442	12	335	16	340
Officer						
Exp / Ventilation	Temperature [°F]		Vertical Heat Flux [kW/m ²] [kJ/m ²]		Horizontal Heat Flux [kW/m ²] [kJ/m ²]	
	$\mu \pm \sigma$	Peak	Peak	Total Energy	Peak	Total Energy
2 / Hydraulic	133 ± 54	311	8	345	6	220
3 / Vertical	-	-	5	154	7	356
5 / Positive Pressure	-	-	12	154	5	207
6 / Door Control	309 ± 110	515	7	118	10	125

Figure 4.8 shows the total time, in seconds, that the maximum (maximum between horizontal and vertical) heat flux exposure of nozzle and officer firefighter positions fell into each of the thermal operating classes [19]. While the maximum exposures were remarkably high, such as the nozzle firefighter in Experiment 4 with a peak heat flux of 27 kW/m² (see Table 4.6), these peak exposures were short in duration. Typically, these exposures occurred immediately prior to the doorway suppression action, after which heat fluxes decreased substantially.

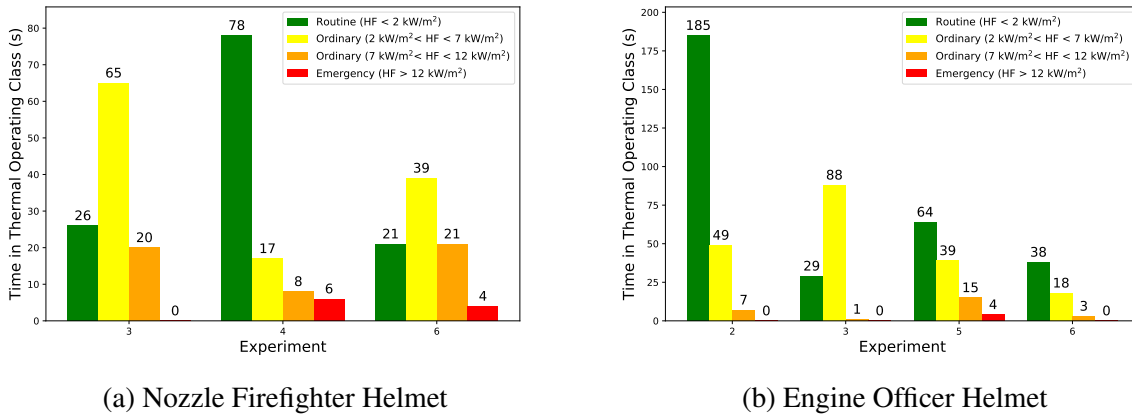

Figure 4.8: Time spent in each thermal operating class according to heat flux criteria for Method 1 Experiments where helmet data was recorded. Green indicates routine operating class ($HF < 2 \text{ kW/m}^2$). Yellow indicates lower half of ordinary operating class ($2 \text{ kW/m}^2 < HF < 7 \text{ kW/m}^2$). Orange indicates upper half of ordinary operating class ($7 \text{ kW/m}^2 < HF < 12 \text{ kW/m}^2$). Red indicates emergency operating class ($HF > 12 \text{ kW/m}^2$).

The officer position tended to spend more time during the suppression actions in the routine operating class or lower half of the ordinary operating class. Experiment 5 was the only experiment where data was recorded in which the officer firefighter was exposed to conditions consistent with the emergency operating class. In this experiment, the initial suppression actions from the stairway were ineffective at reducing temperatures in the fire room. Effective suppression in the fire room was only accomplished once the suppression crew reached the landing, where they were exposed to heat from the fire room doorway at close proximity, leading to a more severe exposure.

For the two experiments where data was available for both the nozzle and officer positions, the nozzle firefighter's exposure reached the upper half of the ordinary operating class and the emergency operating class for a greater period of time than the officer. The nozzle firefighter's exposure was notably high in Experiments 6, spending 29% of the period from the opening of the front door to entry of the fire room above 7 kW/m^2 while spending 18% and 13% in Experiments 3 and 5, respectively. Similar to Experiment 5, this more severe exposure is a result of the geometry of the building and location of the fire room which was not conducive to remote water application. The initial water application in Experiment 6 occurred from the fire room doorway resulting in comparatively high exposure to the nozzle firefighter prior to suppression actions taking effect.

Figure 4.8 also demonstrates that considering only the peak exposure to the suppression crew is important, but only one piece of necessary information. The nozzle firefighter in Experiment 4 experienced a peak heat flux of 27 kW/m^2 , which was the highest of any of the Method 1 experiments. This peak was rather brief, however, and the majority of the nozzle firefighter's exposure in Experiment 4 fell into the routine operating class. Compared to Experiments 3 and 6, the nozzle firefighter in Experiment 4 spent a shorter period of time exposed to heat fluxes above 7 kW/m^2 and had a lower total energy exposure (see Table 4.6). Thus, it is important to consider not only the peak exposure, but cumulative exposure to the firefighters and their PPE.

4.3 Method 2, Second Floor Bedroom Fire – Ventilation During Interior Suppression

Method 2 included three experiments designed to examine the effectiveness of ventilation occurring during or prior to suppression. The three ventilation tactics considered all occurred on second-floor bedroom fires, and examined two vertical ventilation scenarios and simultaneous positive pressure ventilation (PPA). While the two vertical ventilation cases (Experiments 7 and 8) were both conducted at 201/203 Water St., facilitating a more direct comparison of those two experiments, the simultaneous positive pressure ventilation (Experiment 9) was conducted at 1030 Hilltop Rd. Because of this, it is important to consider the effect that differences in building geometry (ceiling height, interior volume, floor plan, etc.) may have had on the fire dynamics when drawing conclusions about the effectiveness of the ventilation tactics used. Table 4.7 shows the times at which the various interventions were performed for the three experiments conducted with Coordination Method 2.

Table 4.7: Coordinated Method 2 Intervention Times

Intervention	Experiment		
	7	8	9
Ignition	00:00	00:00	00:00
Front Door Open	07:10	06:50	06:30
Positive Pressure Attack	—	—	06:41
Suppression Crew Enters	07:16	06:59	06:51
Initial Water Into Bedroom	07:30	07:02	07:11
Roof Vent Open	07:16	06:55	—
Ceiling Vent Open	07:22	07:00	—

Two occupant packages were utilized in each experiment at the locations described in Table 4.8. In Experiments 7 and 8, one occupant package was located in the doorway of the bedroom opposite the fire room and the other was located in the center of the same bedroom. In Experiment 9, the occupant package closest to the fire room was located in the flex space immediately adjacent to the fire room, while the remote occupant package was located in the hallway, stairway landing. Each occupant location had a skin burn assessment package elevated 1 ft above the floor. Gas concentrations were measured 1 ft above the floor for the remote occupant location. Gas concentrations were measured at two elevations for the occupant location closest to the fire (1 ft and 5 ft above the floor for the bedroom doorway occupant in Experiments 7 and 8 and 1 ft and 3 ft above the floor for the flex space occupant location in Experiment 9). Experiments 7 and 8 were the only two experiments in the series where the higher of the two paired gas concentrations was located 5 ft from the floor. Table 4.8 also lists the distance of each occupant package from the fire room doorway and the location with respect to the flow path established between the front door to the fire room doorway.

Table 4.8: Coordinated Method 2 Occupant Tenability Assessment Package Locations

Exp #	Location in Structure	Location with Respect to Flow Path	Distance from Fire Room (ft)
7	Bedroom 1	Remote	28.1
	Bedroom 1 Doorway	Inside	17.8
8	Bedroom 2	Remote	27.0
	Bedroom 2 Doorway	Inside	18.1
9	Hallway	Remote	26.1
	Flex Space	Inside	14.3

Table 4.8 shows the impact of structure geometry on occupant package location. The average distance away from the fire room for the remote occupant package was 27 ft with a standard deviation of 1 ft. For the occupant package inside the flow path, the average distance was shorter, at 17 ft, with a standard deviation of 2 ft. The small standard deviations relative to the mean values indicate that the occupant packages were similarly spaced relative to the fire room during the three experiments.

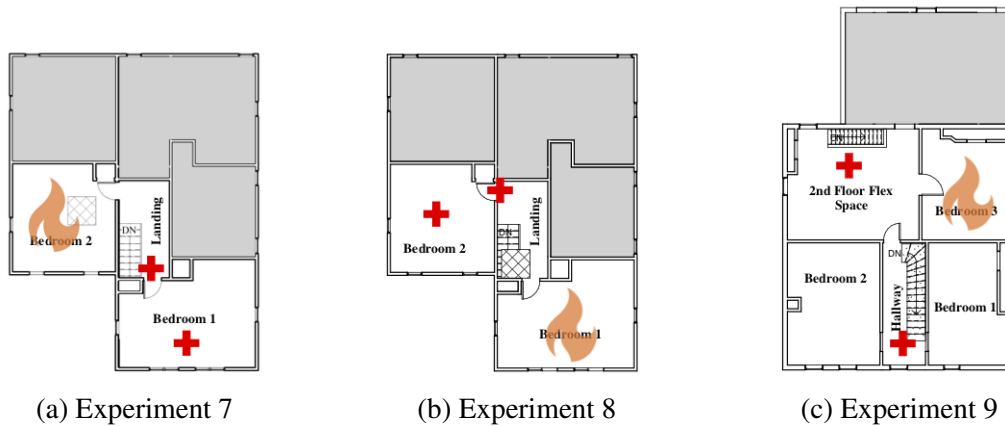

Figure 4.9: Fire floor layouts for acquired structures used in Method 2 experiments. The red crosses represent the approximate locations of the occupant assessment packages. The gray areas were isolated from the remainder of the structure and utilized as space for instrumentation.

4.3.1 Suppression and Ventilation Tactics

Previous research conducted by UL FSRI primarily focused on ventilation tactics in residential fires [1–3] emphasized that many residential structure fires have the potential to be ventilation-limited at the time of fire department arrival. Ventilation of an under-ventilated compartment fire without complimentary suppression can result in fire growth. The time between first ventilation (front door open) and suppression for Method 2 experiments is summarized in Table 4.9.

Table 4.9: Coordinated Method 2 Duration(s) Between First Ventilation and Suppression Events

	Experiment		
	7	8	9
Time from front door open to first water flow (s)	26	41	45
Time from front door open to first water in fire room (s)	42	60	65
Time from front door open to fire room entry (s)	80	76	137

In each of the three experiments, the suppression crew was able to apply water into the fire room doorway within 65 s after the front door was opened. In this time frame between the opening of the front door and subsequent vertical or positive pressure ventilation, temperature increases were measured in the fire room for each of the three experiments in Method 2. In Experiment 7, vertical ventilation over the fire resulted in an almost immediate temperature increase, with fire room temperatures reaching a peak approximately 22 s after vertical ventilation, concurrent with the onset of suppression from the fire room doorway. Similarly, in Experiment 8, temperatures in the fire room began to increase shortly after the completion of the hallway vertical vent, transitioning the room through flashover approximately 30 s after vertical ventilation. The increase in fire room temperatures and pressures in Experiment 9 was more gradual, with the increase beginning 10 seconds after the fan was turned into the doorway, reaching a peak 44 s after the fan was turned in, just prior to suppression in the fire room doorway.

In each of the three experiments, at the time of first intervention (i.e. front door open), the bedroom fire was fully developed for the ventilation conditions present at the time. Once the front door was opened, more air was able to be entrained which allowed for additional fire growth. Further ventilation in the form of vertical ventilation or positive pressure ventilation increased the amount of air that could be entrained through the front door and, consequently, the quantity of hot gases that could be exhausted through horizontal and vertical vents.

Despite the increase in temperatures within the fire room after secondary ventilation actions, temperatures generally decreased in spaces remote from the fire room for each of the experiments in Method 2. Figure 4.10 shows the temperature change from the time the front door was opened until the second prior to initial suppression at locations remote from the fire room. The charts show that elevations closer to the floor and locations close to the flow path showed the greatest temperature decrease. This is because of the ambient air being entrained into the fire room along the inlet of the flow path. In Experiment 7 (vertical vent over fire) and Experiment 9 (positive pressure), the temperatures at elevations closer to the ceiling also decreased, although not as much as at lower elevations. In Experiment 8, the vertical vent over the hallway provided a low-pressure exhaust outside the fire room, allowing hot gases to vent through the top portion of the fire room doorway, into the hallway, and out the vent hole. This resulted in a temperature increase in the 6 ft and 7 ft 11 in. elevations in the stairway landing, as shown in Figure 4.10.

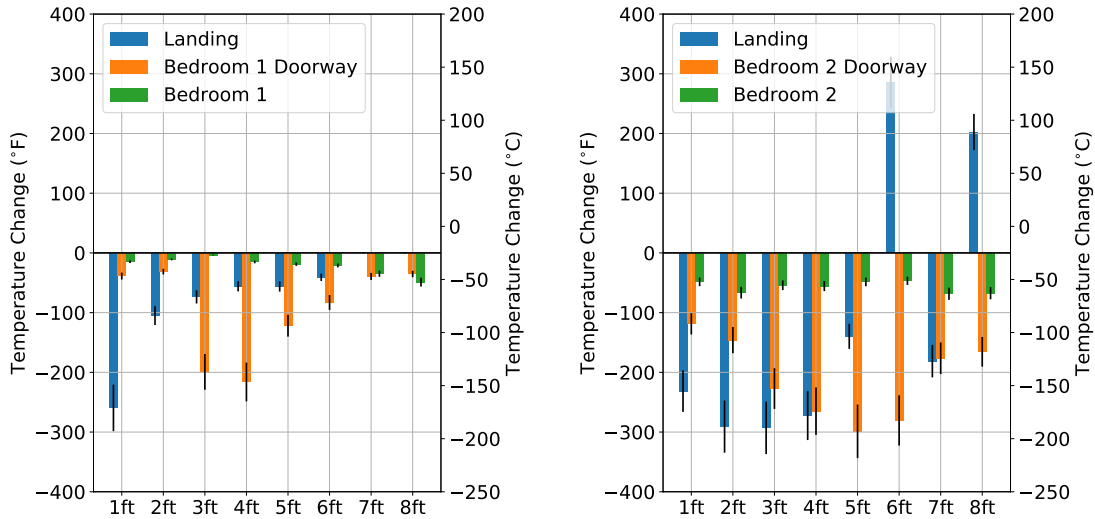

(a) Experiment 7

(b) Experiment 8

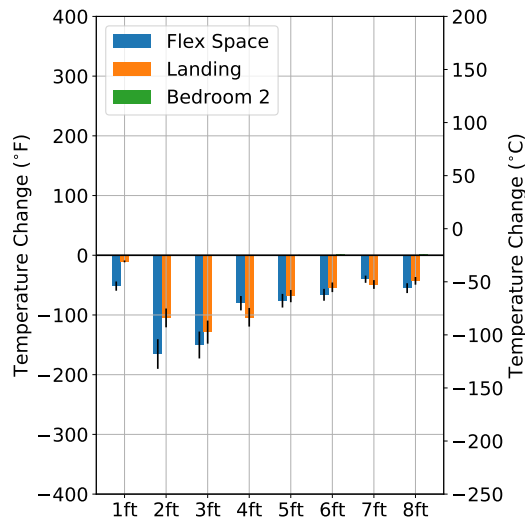

(c) Experiment 9

Figure 4.10: Change in temperature from the time the front door was opened until the second before initial water flow for the suppression crew. Negative values indicate a temperature decrease, while positive values indicate a temperature increase.

In Experiment 7, the landing suppression action did not significantly decrease fire room temperatures, but did reduce temperatures in the stairway landing. This benefit was only present, however, while the nozzle was open. While the initial stairway suppression action in Experiment 8 similarly provided temporary local cooling, the water flow from the landing was effective at reducing the fire room temperatures, as the nozzle firefighter had a line of sight that enabled direct water application into the fire room. The 6 s landing suppression action reduced the fire room temperatures from above 2000 °F to between 780 °F and 1475 °F, but these temperatures recovered

after water flow stopped. The 14 s doorway suppression further reduced temperatures to between 275 °F and 900 °F, after which they continued to decrease as the suppression crew commenced final suppression. The remote suppression actions in Experiments 7 and 8 show that although remote suppression actions may not have a significant impact on fire room temperatures, water flow remote from the fire room can be effective at local cooling. While water flow outside the fire room temporarily cooled the immediate area, the temperatures quickly recovered once water flow stopped. In Experiment 9, the fire room was not in a direct sight line from the stairwell as it required travel through the flex space (recall from Figure 3.101). As a result, the most effective temperature reductions occurred from fire room doorway suppression.

During each experiment in Method 2, the nozzle firefighter employed a “shutdown and move” method of hoseline advancement, where the crew would stop their advancement toward the fire room, apply water for a period of time, and then resume their advancement after shutting down. In each case, the nozzle firefighter applied water at least once before reaching the fire room doorway. Figure 4.11 compares the impact of suppression actions prior to reaching the fire room doorway on fire room temperatures and landing temperatures for the 150 s following the opening of the front door in Experiments 7, 8, and 9. While water application prior to reaching the fire room doorway had mixed results among the three experiments, the doorway suppression action had the most significant cooling within the fire room for each of the three experiments. In Experiment 7, the 26 s doorway suppression action reduced temperatures from above 1700 °F at the beginning of the flow to between 425 °F and 160 °F at the end of the flow. The 14 s initial doorway suppression in Experiment 8, reduced temperatures that were over 1200 °F at 4 ft above the floor in the fire room, to approximately 475 °F. Similarly, in Experiment 9, the 21 s doorway suppression action reduced the fire room temperatures from 1400 °F at the start of water flow to less than 250 °F at the end of water flow at all elevations. The reason that the doorway flow was the most effective at reducing fire room temperatures is because from this location, the nozzle firefighter can apply water to any burning surface in the fire room that is not shielded by obstructions, allowing for efficient surface cooling and fuel wetting.

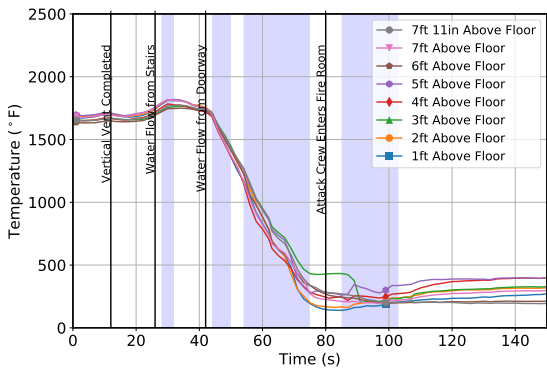

(a) Experiment 7 Fire Room

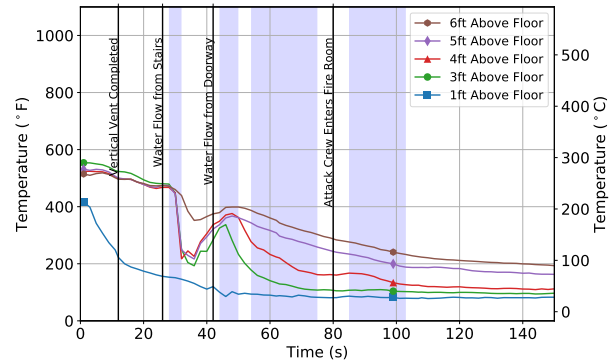

(b) Experiment 7 Landing

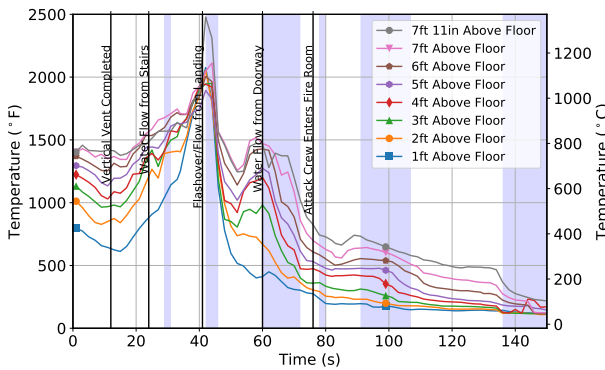

(c) Experiment 8 Fire Room

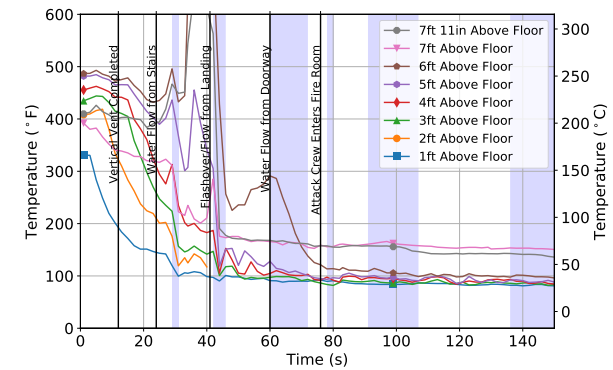

(d) Experiment 8 Landing

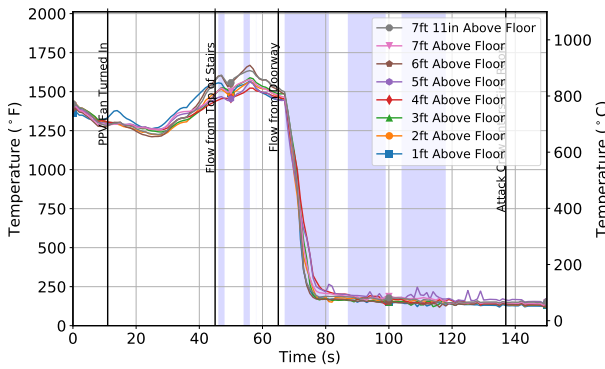

(e) Experiment 9 Fire Room

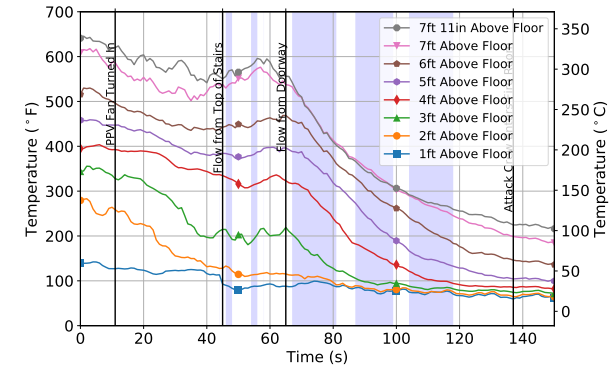

(f) Experiment 9 Flex Space

Figure 4.11: Suppression effects on fire room and landing temperatures for Experiments 7, 8, and 9. Time = 0 corresponds to the front door being opened and data is included for 150 s after fire department intervention.

In both vertical ventilation experiments, an improvement in visibility was observed in the minute following initial firefighter intervention (door opening). Due to the layout of the structure in Experiment 9 (the flex space was offset from the post-ventilation flow path) and the camera positioning

on the side B wall far from the doorway to the fire room, a direct comparison to visibility recovery in Experiments 7, 8, and 9 is not tractable. Figure 4.12 shows the change in hallway visibility during this period for both vent locations in the 60 s. following the front door open. Visibility in Experiments 7 and 8 increased because of the additional fresh air that was able to be entrained through the hallway along the intake (lower) portion of the flow path. This finding is consistent with previous research on vertical ventilation [2], particularly for vent holes located outside the fire room.

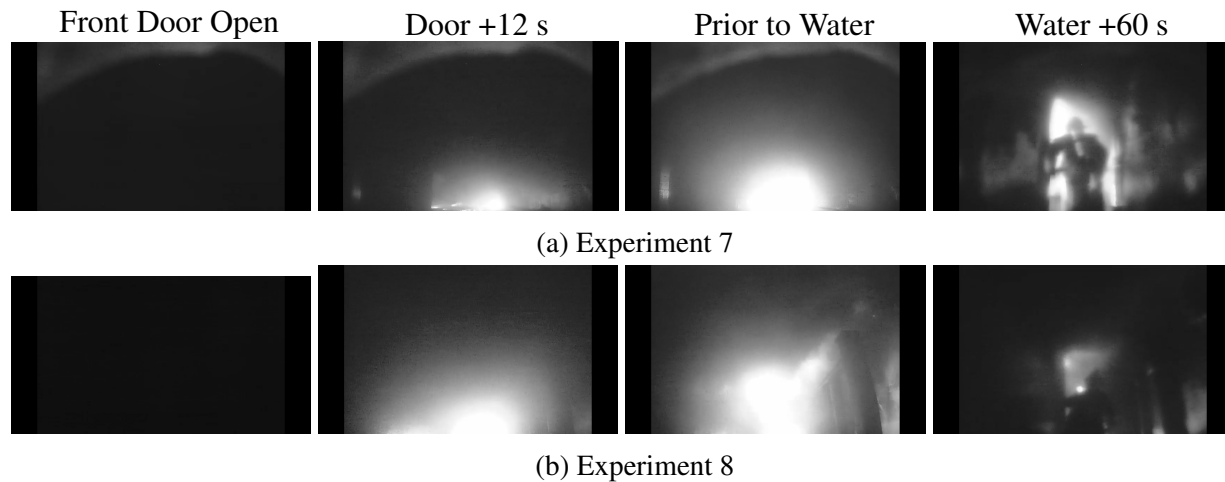

Figure 4.12: Change in visibility in the 60 s. following front door opening for Experiments 7 and 8. Images show the visibility in the hallway camera at the the time of front door open (left), 12 s after the front door opening, which corresponds to the completion of the vertical vent for Experiments 7 and 8 (middle left), immediately prior to initial water application in the stairway (middle right), and 60 s. following initial suppression (far right).

4.3.2 Occupant Tenability Estimate

The effects of the coordinated ventilation and suppression tactics can be evaluated by considering the time histories of the gas concentrations variations at the two occupant locations for each of the three experiments in Method 2. These gas concentrations were used to compute the fractional effective dose (FED) and fractional effective rate (FER). Table 4.10 summarizes the FED value at the time of the first fire department intervention, the final FED at the end of the experiment, and the time elapsed from the opening of the front door to the peak FER and time the CO concentrations dropped below 0.12% (1200 ppm).

Table 4.10: Coordinated Method 2 Occupant Tenability Estimate

Exp	Occupant Location	FED at Front Door Open	Final FED	Time* to Peak FER [s]	CO at Front Door Open [ppm]	Time* to CO < 1200 ppm [s]
7	Bedroom 1 1 ft	1.7	3.1	11	11700	137
	Bedroom 1 Doorway 1 ft	3.9	4.4	11	15200	78
	Bedroom 1 Doorway 5 ft	16.3	20.1	-	19000	354
8	Bedroom 2 Doorway 1 ft	1.1	1.2	10	11400	65
	Bedroom 2 Doorway 5 ft	2.8	3.9	24	9300	194
9	Hallway 1 ft	0.1	0.2	11	2050	11
	Flex Space 1 ft	0.2	0.6	5	4100	165
	Flex Space 3 ft	1.9	3.8	-	16900	204

* Times are expressed as time elapsed after the initial fire department intervention (front door open)
 - indicates peak FER occurred at front door open.

Although the vertical vent locations in Experiments 7 and 8 were different, in each case the peak FER rate at 1 ft in the remote bedroom doorway was observed at the time that the vertical vent was completed. This indicates the fresh air entrained into the stairway following the opening of the front door and completion of the vertical vent decreased the CO and CO₂ at that location. The FER then briefly increased until approximately 30 s after the opening of the front door, before a final drop coinciding with suppression. The 5 ft gas concentrations did not exhibit the same immediate response to ventilation as the 1 ft locations.

In Experiment 7, CO concentration measured at 1 ft elevation in the remote bedroom doorway was the first to decrease below 0.12% (1200 ppm), 78 s after the front door was opened. This was followed by the 1 ft occupant location in the center of the remote bedroom at 137 s and the 5 ft occupant location in the remote room doorway at 354 s. In Experiment 8, the 1 ft and 5 ft remote doorway CO concentrations decreased below 0.12% (1200 ppm) at 65 s and 194 s after the front door was opened, respectively. The gas concentration data suggest that prior to suppression, locations closest to the inlet portion of the flow path are the most impacted by changes in fire department ventilation actions. In Experiments 7 and 8, the occupant location closest to the inlet portion of the flow path received the most immediate positive benefit from ventilation actions.

In Experiment 9, the FER at the time of intervention was significantly lower, and therefore the benefit was not as noticeable. The introduction of the fan, however, decreased the FER at the 3 ft flex space occupant location to a steady value, which then further decreased as suppression began in the fire room doorway. The 1 ft flex space occupant location remained higher than 0.12% (1200 ppm) for 165 s compared to 204 s for the 3 ft level.

The FEDs at the time of fire department intervention varied between 0.1 and 16.3 for the eight occupant locations where data was recorded. Generally, as elevation in the room increased, the FED also increased. Additionally, occupant locations closer to the floor and remote from the fire room tended to have lower cumulative doses at the time the front door was opened. All of the occupant locations except both 1 ft locations in Experiment 9 exceeded the criteria for incapacitation

(FED = 1.0) at the time of fire department intervention.

Skin burn assessment packages were co-located with the gas sample points at the occupant locations. Table 4.11 shows the peak surface and subdermal temperatures that were recorded at each occupant location and the time from ignition until the temperature exceeded 111 °F (44 °C), the minimum threshold for thermal injury.

Table 4.11: Coordinated Method 2 Pig Skin Temperatures

Exp	Location	Surface Temperature		Subdermal Temperature	
		Time to 111 °F [s]	Peak [°F]	Time to 111 °F [s]	Peak [°F]
7	Bedroom 1	-	108	-	89
	Bedroom 1 Doorway	433	112	-	106
8	Bedroom 2	-	110	-	107
	Bedroom 2 Doorway	320	133	462	114
9	Hallway	-	90	-	98
	Flex Space	224	157	308	123

- indicates value not reached during experiment

The surface temperature exceeded 111 °F (44 °C) at the occupant location closest to the fire room (remote room doorway in Experiments 7 and 8, flex space in Experiment 9) for each of the three experiments. Additionally, the peak subdermal temperature exceeded 111 °F (44 °C) at the closest occupant location in Experiments 8 and 9, suggesting the possibility of deeper burns in a shorter period of time. The flex space occupant in Experiment 9 experienced the highest peak surface and subdermal temperatures, which is likely because it was located 14.3 ft from and inline with the fire room doorway. The remote bedroom doorway occupants were located 17.8 ft and 18.1 ft from the fire room doorway in Experiments 7 and 8, respectively, and were offset from the doorway. The peak surface and subdermal temperatures were also higher in Experiment 8 than in Experiment 7, which is a result of the fire conditions in the stairway after the vertical vent was completed and prior to suppression.

The opening of the front door and vertical ventilation actions in Experiments 7 and 8 provided a similar benefit in terms of surface temperature reduction as was observed in FER and gas concentration. The peak surface temperature in each of the two experiments coincided with the completion of the vertical vent, and continued to decrease as suppression actions were completed. In Experiment 9, the introduction of the PPV fan slowed the rate of increase of surface temperatures, but the most significant reduction in temperature came with the stairway suppression action. Although this suppression action was not effective at reducing fire room temperatures and was minimally effective at reducing flex space temperatures, it reduced the surface temperature of the skin burn assessment package from 150 °F to approximately 105 °F.

The close timing of ventilation actions and initial suppression actions resulted in a benefit to potential occupants by reducing toxic gas concentrations and local temperatures during the suppression

period. In each of the three scenarios, gas concentrations began to improve with the introduction of pre-suppression ventilation, and continued to improve as suppression took effect in the fire room. In Experiments 7 and 8, the reduction of temperatures was closely tied with the completion of the vertical vent, whereas in Experiment 9, the most significant temperature reduction occurred at the same time as the stairway suppression action.

Previous research [2] emphasized the importance of timing and coordination of vertical ventilation. Vertical ventilation occurring directly over the seat of the fire resulted in additional fire growth more quickly than vertical ventilation occurring remotely from the seat of the fire. Further, when a vertical vent hole was placed remote from a bedroom fire, visibility and thermal conditions in the flow path leading to the fire room improved. The coordinated suppression with vertical ventilation in Experiments 7 and 8 were consistent with the findings of previous research. In each case, initial water application occurred within 30 s of the front door being opened. Because of the close timing of suppression and ventilation, there was less time for the additional air entrained by the fire to precipitate fire growth. The interaction of the hoseline with the flow path is important, as evidenced by the relationship between the gas concentration changes and the times at which the nozzle was shut on and off.

4.3.3 Firefighter Helmet Thermal Exposure

Table 4.12 summarizes the peak and average temperatures, the peak heat flux, and the total energy exposure. Data for the officer position, who was directly behind the firefighter during the advancement toward the fire room, was captured for Experiments 7 and 8, while nozzle firefighter data was captured in Experiments 8 and 9.

Table 4.12: Thermal Exposure to Nozzle and Officer Firefighter Helmets – Method 2

Nozzle Firefighter						
Exp / Ventilation	Temperature [°F]		Vertical Heat Flux [kW/m ²] [kJ/m ²]		Horizontal Heat Flux [kW/m ²] [kJ/m ²]	
	$\mu \pm \sigma$	Peak	Peak	Total Energy	Peak	Total Energy
8 / Vertical Over Hall	133 ± 102	427	8.3	144	23.1	324.2
9 / Positive Pressure	80 ± 28	168	20.5	259	7.6	124
Officer						
Exp / Ventilation	Temperature [°F]		Vertical Heat Flux [kW/m ²] [kJ/m ²]		Horizontal Heat Flux [kW/m ²] [kJ/m ²]	
	$\mu \pm \sigma$	Peak	Peak	Total Energy	Peak	Total Energy
7 / Vertical Over Fire	69 ± 22	116	10.6	94	4.1	45.5
8 / Vertical Over Hall	78 ± 43	210	15.8	331	14.9	304

The peak temperatures and heat fluxes that were recorded in each experiment were high when com-

pared to design thresholds for firefighter turnout gear and previous research. Figure 4.13 shows the amount of time, in seconds, from the entry of the suppression team to the completion of suppression in the fire room that each suppression position spent in each of the thermal operating classes based on heat flux criteria.

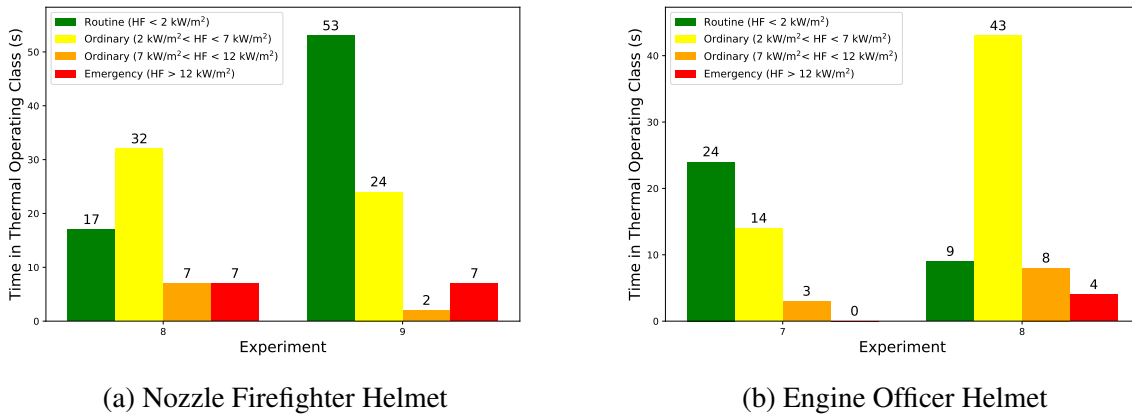

Figure 4.13: Time spent in each thermal operating class according to heat flux criteria for Method 2 Experiments where helmet data was recorded. Green indicates routine operating class ($HF < 2 \text{ kW/m}^2$). Yellow indicates lower half of ordinary operating class ($2 \text{ kW/m}^2 < HF < 7 \text{ kW/m}^2$). Orange indicates upper half of ordinary operating class ($7 \text{ kW/m}^2 < HF < 12 \text{ kW/m}^2$). Red indicates emergency operating class ($HF > 12 \text{ kW/m}^2$).

The nozzle firefighter in Experiment 8 sustained the highest peak temperature and heat flux exposures out in the Method 2 experiments at $427 \text{ }^\circ\text{F}$ and 23.1 kW/m^2 . The data captured for the officer position for this experiment had a lower peak temperature and heat flux ($210 \text{ }^\circ\text{F}$) and 15.8 kW/m^2 , respectively). Despite the lower peak heat flux, the officer position sustained a total energy exposure comparable to the nozzle position. This is reflected in Figure 4.13, which shows that the officer position spent a comparable, but slightly greater amount of time than the nozzle firefighter in the ordinary and emergency operating classes (55 s compared to 46 s). Further, the officer and nozzle positions spent a slightly greater proportion of the operation exposed to heat fluxes above 7 kW/m^2 (12 s and 14 s, respectively). The reason for the higher exposure in this experiments is the proximity of the hallway vent to the fire room doorway. The low-pressure in the hallway following the vent allowed flaming combustion in the landing, through which the suppression team had to advance to reach the fire room and complete suppression.

The exposures to the nozzle and officer positions in Experiments 7 and 9 were lower than the corresponding position in Experiment 8. The officer position in Experiment 7 was exposed to a lower peak heat flux and temperature than the officer position in Experiment 8. The peak heat flux and temperature in Experiment 7 were $116 \text{ }^\circ\text{F}$ and 10.6 kW/m^2 . The lower total energy exposures listed in Table 4.12 is illustrated in Figure 4.13b, which shows that the engine officer spent most of the suppression portion of the experiment in the lower half of the ordinary operating class and the routine operating class. In a similar fashion, the nozzle firefighter in Experiment 9 experienced a peak temperature and heat flux of $168 \text{ }^\circ\text{F}$ and 20.5 kW/m^2 , respectively. The total energy exposure

was lower than in Experiment 8, which is further illustrated in Figure 4.13a. The chart shows that the nozzle firefighter in Experiment 9 spent less time in the ordinary and emergency operating classes than the nozzle firefighter in Experiment 8.

Among the reasons for the difference in exposures across the three experiments is the layout of the structure. The suppression teams in Experiments 7 and 9 were shielded from the fire room by walls until they reached the fire room doorway. In these experiments, the peak heat fluxes and temperatures were measured as the suppression team reached the fire room and began suppression from the fire room doorway. Further, the period of time that the suppression team was exposed to heat fluxes close to the peak was relatively short, since fire room suppression significantly reduced these exposures. In Experiment 8, on the other hand, the suppression team had to travel through exhaust from the fire room as they traveled from the stairway to landing to fire room. Although the time required to reach the fire room was comparable among the three experiments, the suppression crew in Experiment 8 experienced a more severe insult than the other two experiments because the placement of pre-suppression ventilation resulted in fire spread into the hallway.

The results of these experiments show that although the peak heat fluxes that firefighters were exposed to were severe, suppression actions quickly reduced these heat fluxes. Further, it shows that peak exposures alone do not tell the entire story, as it neglects an important time component.

4.4 Method 3, Second Floor Bedroom Fire - Ventilation Post Initial Exterior Suppression

Method 3 included three experiments designed to look at the effectiveness of ventilation occurring immediately following exterior suppression. The three ventilation tactics considered all occurred on second-floor bedroom fires. The three experiments include a baseline experiment, in which no additional ventilation was performed, a positive pressure ventilation experiment, and an additional horizontal ventilation experiment. All three of the experiments in Method 3 were conducted in the structure at 230 Walnut St. Table 4.13 shows the times at which the various interventions were performed for the three experiments..

Table 4.13: Coordinated Method 3 Intervention Times

Intervention	Experiment		
	10	11	12
Ignition	00:00	00:00	00:00
Initial Exterior Water	07:32	07:31	07:01
Front Door Open	07:44	07:49	07:15
Suppression Crew Enters	08:44	08:49	08:15
Interior Suppression Begins	09:01	09:09	08:45
Positive Pressure Ventilation	—	07:54	—
Additional Horizontal	—	—	07:15

Table 4.14 lists the locations of the occupant packages, along with their distance from the fire room doorway. These occupant packages were located at the top of the stairs in the second-floor hallway and in one of the remote bedrooms. At each of these occupant locations, skin burn assessment packages were located 1 ft from the floor, which recorded surface, subdermal, and ambient temperatures. Additionally, gas concentrations were monitored 1 ft and 3 ft above the floor in the hallway and 1 ft above the floor in the remote bedroom.

Table 4.14: Coordinated Method 3 Occupant Tenability Assessment Package Locations

Exp #	Location in Structure	Location with Respect to Flow Path	Distance (ft) from Fire Room
10	Bedroom 3	Remote	13.6
	Hallway	Inside	8.0
11	Bedroom 3	Remote	15.9
	Hallway	Inside	17.0
12	Bedroom 1	Remote	15.1
	Hallway	Inside	10.8

Table 4.14 shows the impact of structure geometry on occupant package location. The average distance away from the fire room for the remote occupant package was 15 ft with a standard deviation of 1 ft. For the occupant package inside the flow path, the average distance was shorter, at 12 ft, with a standard deviation of 4.5 ft. The small standard deviation relative to the mean value for the remote package indicates similarly spaced instrumentation packages for these experiments. For the flow path occupant packages, the larger standard deviation indicates, independent of tactics examined, the distance from fire room may play a role in occupant data variability. Figure 4.14 summarizes the fire floor layouts for each experiment in Method 3.

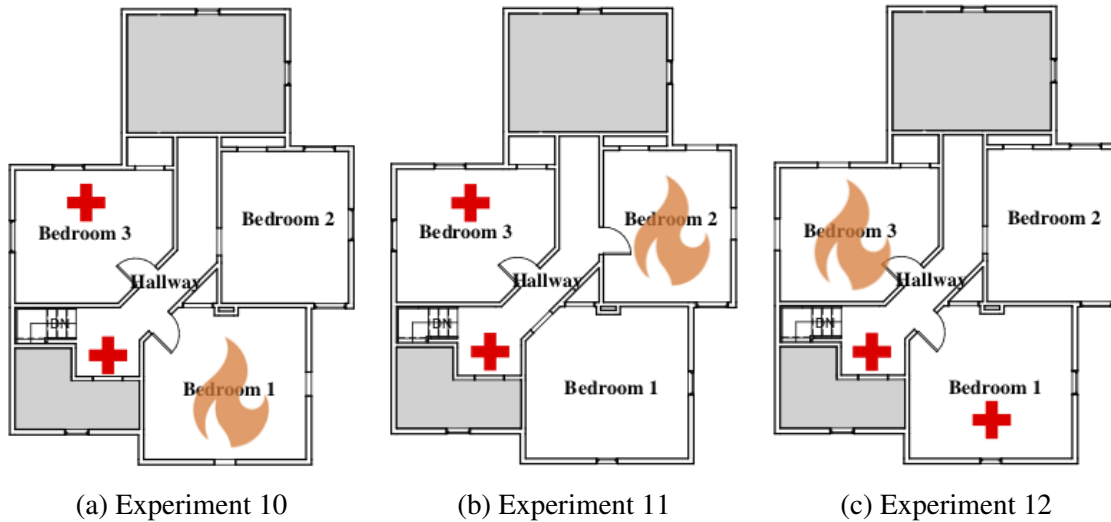

Figure 4.14: Fire floor layouts for acquired structures used in Method 3 experiments. The red crosses represent the approximate locations of the occupant assessment packages. The gray areas were isolated from the remainder of the structure and utilized as space for instrumentation.

4.4.1 Suppression and Ventilation Tactics

In each of the three Method 3 experiments, the first fire department intervention was the exterior suppression action, which lasted for 10 seconds in each case. After the nozzle was shut down, the front door was opened and the respective vent actions were executed. The suppression team delayed entry for 60 seconds following the opening of the front door. This delay was done to simulate the relocation of the line from the side of the building closest to the fire room to the front door. Additionally, it allowed time to assess fire regrowth following the exterior suppression.

In all three experiments, the exterior suppression action reduced temperatures and pressures within the fire room. Fire growth following the exterior suppression action was observed in each of the three Method 3 experiments. The regrowth is best reflected in the hallway temperatures outside the fire rooms as these thermocouples were not damaged by water flow. Figure 4.15 shows the temperatures in the hallway outside the fire room in the period following the exterior suppression action.

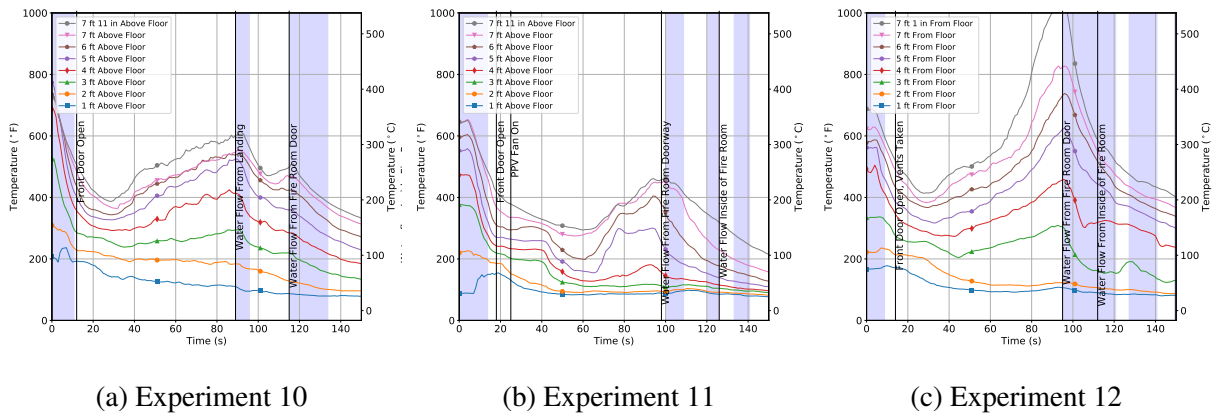

Figure 4.15: Temperature regrowth in the hallway following exterior suppression for Method 3 experiments. Time = 0 corresponds to the beginning of the exterior suppression action and data is included for 150 s after fire department intervention.

Table 4.15 summarizes the data presented in the charts in Figure 4.15. The table highlights the temperatures prior to exterior (ext.) suppression, the time elapsed from the exterior suppression until temperature regrowth began in the hallway (i.e. the time to reach minimum temperatures), the minimum hallway temperature following the exterior suppression, the regrowth temperature (or temperature prior to interior suppression, and the time from the initial fire department intervention until the suppression crew entered the fire room.

Experiment 10 resulted in the most rapid time to the onset of regrowth of the three experiments, with temperatures in the hallway beginning to increase 16 seconds after the exterior suppression ended. Temperatures in the hallway reduced by 390 °F and 245 °F at 7 ft 11 in. and 4 ft elevations, respectively, before starting to increase again.

Regrowth was similar in Experiment 12, where temperatures began to increase approximately 20 seconds after the end of exterior suppression. The exterior water application reduced temperatures 275 °F and 215 °F at 7 ft 11 in. and 4 ft elevations, respectively. The regrowth in Experiment 12 reached the highest temperatures of the three experiments, with ceiling temperatures peaking at 1030 °F and visible flames in the hallway.

The exterior suppression in Experiment 11 exhibited the longest period between exterior suppression and the onset of regrowth, at 50 s. Temperatures in the hallway dropped as a result of exterior suppression, then further dropped 39 s after fire department intervention (14 s after the PPV fan was turned in). The impact of the fan was most noticeable between 4 ft and 6 ft temperatures, and may possibly be the reason that the onset of regrowth was delayed in this experiment.

In each of the experiments, upon completion of the exterior suppression no fire remained visible through the bedroom windows. By the time final suppression occurred from the fire room doorway, however, fire was once again visible from the bedroom windows, showing the importance of continued coordination between suppression and ventilation.

Table 4.15: Times and Temperatures Between Exterior and Interior Water

	Height Above Floor	Experiment		
		10	11	12
Temperature prior to ext. suppression	7 ft 11 in.	725 °F	655 °F	690 °F
	4 ft	685 °F	475 °F	490 °F
Time from ext. suppression to minimum hallway temperature		16 s	50 s	20 s
Minimum temperature between ext. & int. suppression	7 ft 11 in.	480 °F	295 °F	415 °F
	4 ft	295 °F	120 °F	275 °F
Temperature prior to interior suppression	7 ft 11 in.	600 °F	455 °F	1030 °F
	4 ft	415 °F	180 °F	460 °F
Time from ext. suppression to fire room entry		169 s	126 s	112 s

4.4.2 Occupant Tenability Estimate

Gas concentration data was captured for each of the three occupant locations for Experiments 10-12. The gas concentrations were used to compute the fractional effective dose (FED) and fractional effective rate (FER) for each experiment. The FED values at the time of the front door opening and at the end of the experiment along with the time elapsed from the opening of the front door to the peak FER and time the CO concentrations dropped below 0.12% (1200 ppm) provide insight into how these factors impacted occupant tenability (Table 4.16).

Occupant locations in the Method 3 experiments were located at 1 ft and 3 ft from the floor in the hallway and 1 ft from the floor in a bedroom remote from the fire room. In Experiments 10 and 11, the CO and CO₂ concentrations 1 ft above the floor remained low throughout the experiments and the oxygen concentrations remained close to ambient. As such, the FED and FER values at these locations also remained low over the course of the experiment, as summarized in Table 4.16. The toxic exposure was higher at the 3 ft hallway occupant location in all three experiments. In Experiment 10, the 3 ft FED at the time of intervention was more than 12 times the incapacitating dose for 50% of the population. Exterior suppression caused a brief increase in the hallway FER, before a drop to negligible values following the completion of exterior suppression and the opening of the front door. Despite the fire regrowth in the bedroom, the FER remained low for the rest of the experiment because of the fresh air flowing through the hallway occupant location, which reduced toxic gas concentrations and increased oxygen concentrations.

Table 4.16: Coordinated Method 3 Occupant Tenability Estimate

Exp	Occupant Location	FED at Ext. Suppression	Final FED	Time* to Peak FER [s]	CO at Ext. Suppression [ppm]	Time* to CO < 1200 ppm [s]
10	Bedroom 3 1 ft	0	0	-	+	#
	Hallway 1 ft	0.1	0.1	86	250	86
	Hallway 3 ft	12.4	15.0	119	12600	119
11	Bedroom 3 1 ft	0	0	-	+	#
	Hallway 1 ft	0	0	51	+	#
	Hallway 3 ft	0.2	0.8	28	2700	59
12	Bedroom 1 1 ft	5.1	9.9	23	17500	136
	Hallway 1 ft	0.2	0.8	5	4800	115
	Hallway 3 ft	48.7	62.9	30	29600	154

* Times are expressed as time elapsed after the initial fire department intervention (exterior suppression)
 - indicates peak FER occurred at front door open.
 + indicates CO concentrations below measurement error.
 # indicates CO did not increase beyond 1200 ppm.

In contrast to the other two experiments, the 3 ft hallway FED at the time of intervention in Experiment 11 was rather low—0.2. Partial ceiling failure as a result of exterior suppression caused movement of products of combustion down the hallway toward the occupant location, which rapidly caused the FED and FER to increase. The combination of the open front door and PPV fan quickly reduced these concentrations, with the 3 ft hallway FER peaking 28 s after the start of exterior suppression. The hallway occupant CO concentrations dropped below IDLH conditions (0.12% (1200 ppm)) more quickly than the other Method 3 experiments, although it is possible that this is because the value at the time of intervention was significantly less than the other two experiments.

In Experiment 12, the FED values at the time of fire department intervention were higher than the other two experiments. Additionally, it was the only one of the three experiments where an appreciable increase in FED was observed at either of the 1 ft occupant locations. The FER at 3 ft in the hallway began to decrease during exterior suppression, and further decreased as the front door was opened and a flow path was established through the hallway. The FER at 1 ft began to decrease after the opening of the front door and ventilation of the bedroom window.

Ventilation of the bedroom window in Experiment 12 was effective in reducing the CO concentration and FER in an area that was previously remote from the flow path. CO concentrations dropped below 0.12% (1200 ppm) in a timeframe similar to the improvement observed in the 1 ft and 3 ft locations in the hallway. Because horizontal ventilation of the bedroom window occurred at the same time as the opening of the front door, the bedroom occupant package benefited from the air entrainment through the window. The benefit provided by horizontal ventilation close to the occupant location is further illustrated by the temperature difference between the bedroom occupant temperatures between Experiments 10 and 12, shown in Figure 4.16. Figure 4.16 shows the local air temperature, average surface pig skin temperature, and average subdermal pig skin temperature.

The air temperature at the time of fire department intervention was comparable between the two experiments. Following exterior suppression, the local temperature and surface temperature began to decrease, although this decrease was more rapid in Experiment 12. Horizontal ventilation of the bedroom caused the temperature to drop from 150 °F (66 °C) to 91 °F (33 °C) in 37 seconds, whereas the decrease in Experiment 10 was more gradual. As a result, the surface and subdermal temperatures in Experiment 12 stopped increasing prior to those in Experiment 10.

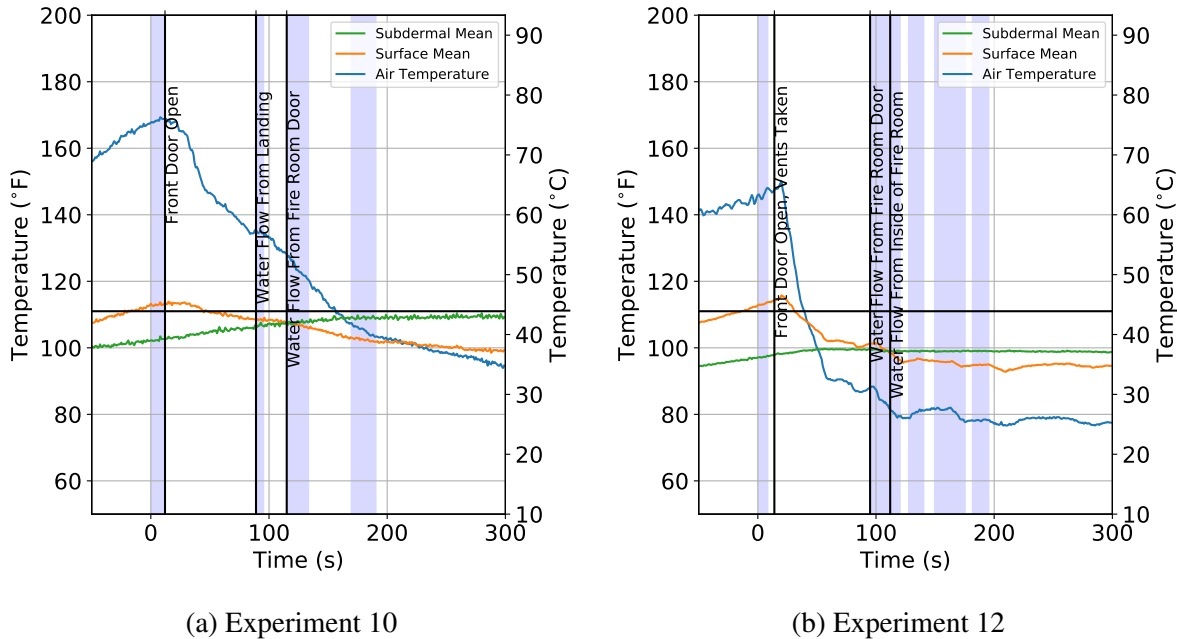

Figure 4.16: Comparison of occupant package temperatures 1 ft from the floor of the remote bedroom. In Experiment 12, the bedroom window was ventilated and in Experiment 10 it was not. Data is presented for the 50 s preceding and 300 s following exterior suppression, with time = 0 corresponding to the start of exterior suppression.

Skin burn assessment data were recorded at the occupant locations in the hallway for all three experiments and in the remote bedroom for Experiments 10 and 12. Table 4.17 summarizes the peak surface and subdermal temperatures, as well as the time elapsed from the beginning of the experiment until the temperatures exceeded 111 °F (44 °C). In Experiments 10 and 12, the remote bedroom occupant package reached a peak surface temperature immediately after the end of the exterior suppression action. This indicated the exterior water application was effective at reducing the thermal threat at these locations. The surface temperatures decreased for the remainder of the experiment, although this decrease was more rapid in Experiment 12, where there was additional horizontal ventilation close to the remote occupant package. The surface temperature in the remote bedroom briefly exceeded 111 °F (44 °C) in each experiment, prior to the decrease resultant from exterior suppression.

Table 4.17: Coordinated Method 3 Pig Skin Temperatures

Exp	Location	Surface Temperature		Subdermal Temperature	
		Time to 111 °F [s]	Peak [°F]	Time to 111 °F [s]	Peak [°F]
10	Bedroom 3	436	114	-	110
	Hallway	288	135	-	110
11	Hallway	468	113	-	109
12	Bedroom 1	410	116	-	100
	Hallway	328	128	-	109

- indicates value not reached during experiment

A similar decrease in surface temperature was noted at the hallway occupant location for each of the three experiments. Unlike the remote bedroom occupant location, the hallway locations benefited from both the fresh air entrained by the open front door and the cooling from the suppression action. After the opening of the front door, the surface temperature decreased for the remainder of the experiment. In all three experiments, the combination of exterior suppression and the opening of the front door similarly resulted in an immediate drop in surface temperatures, but temperatures gradually began to increase shortly afterward as the bedroom fire regrew. Further, in Experiment 11, a spike in surface temperature was observed during the exterior suppression action, consistent with the movement of products of combustion down the hallway that was described in Section 3.11.

In each Method 3 experiment, fire regrowth was observed in the period between initial exterior suppression and final interior suppression. In some cases, this regrowth created temperatures at 4 ft in the hallway in excess of 400 °F and peak heat flux exposures to the firefighters on the suppression crew in excess of 18 kW/m². Despite the regrowth that was observed, the exterior suppression action reduced thermal conditions in the bedroom such that they were no longer consistent with a post-flashover fire. Further, exterior suppression and subsequent ventilation improved conditions at the occupant locations in the hallway and the bedroom, although in some cases this improvement was temporary. Previous research studies on exterior suppression emphasized that minimizing the time between exterior suppression and interior suppression will limit the potential regrowth of the fire [6]. The results of these experiments reinforce that regrowth can occur if interior suppression is delayed, but also demonstrate that the exterior suppression combined with effective ventilation tactics can improve occupant tenability in the meantime.

4.4.3 Firefighter Helmet Thermal Exposure

Data were collected during the fire suppression period from both the nozzle and officer positions in Experiment 10 and the officer position in Experiment 12. Table 4.18 lists the peak and average temperatures, peak heat fluxes in the horizontal and vertical direction, and the total energy exposure

in the horizontal and vertical direction for the helmets from which data were recorded.

Table 4.18: Thermal Exposure to Nozzle and Officer Firefighter Helmets – Method 3

Nozzle Firefighter						
Exp / Ventilation	Temperature [°F]		Vertical Heat Flux [kW/m ²] [kJ/m ²]		Horizontal Heat Flux [kW/m ²] [kJ/m ²]	
	$\mu \pm \sigma$	Peak	Peak	Total Energy	Peak	Total Energy
10 / No additional	133 ± 111	320	6.2	154	17.5	553
Officer						
Exp / Ventilation	Temperature °F		Vertical Heat Flux kW/m ² kJ/m ²		Horizontal Heat Flux kW/m ² kJ/m ²	
	$\mu \pm \sigma$	Peak	Peak	Total Energy	Peak	Total Energy
10 / No additional	142 ± 106	174	8.7	366	6.5	144
12 / Horizontal	106 ± 70	180	18.2	404	10.2	284

Heat flux measured prior to fire department entry into the structure were negligible. In each of the three experiments, the initial interior suppression actions were at or immediately outside the fire room doorway. The peak heat fluxes and temperature in Experiment 10 were observed immediately prior to the landing suppression action, and were 320 °F and 17.5 kW/m², respectively. The officer position in Experiment 10 experienced a peak temperature of 174 °F and a lower peak heat flux of 8.7 kW/m². Additionally, the nozzle firefighter experienced a higher total energy exposure compared to the officer position.

The officer position in Experiment 12 experienced a higher peak heat flux than both the nozzle and officer positions in Experiment 10, at 18.2 kW/m². Although the peak heat flux was rather high, the peak temperature was lower than the firefighter in Experiment 10, with a peak of 180 °F. The reason for the high peak heat flux and lower temperature is because the officer’s thermal exposure in Experiment 12 is mostly from radiation from the fire venting into the hallway as the suppression crew advanced toward the fire room.

The peak heat fluxes that the Experiment 10 nozzle firefighter and Experiment 12 officer were exposed to were consistent with emergency operating conditions, while the peak heat flux exposure for the Experiment 10 officer was consistent with ordinary operating conditions. Figure 4.17 shows the amount of time spent in each exposure threshold during the fire suppression period (from the beginning of exterior water to the suppression crew’s entry into the fire room). The figure shows that the nozzle and officer positions in both experiments spend minimal amounts of time, comparatively, in the upper half of the ordinary and the emergency operating classes. Although the time lapse between initial exterior and final interior suppression allowed regrowth of the fire to the point where flames were visible in the fire room and out the windows, the interior suppression actions quickly reduced the thermal insult to the suppression crew.

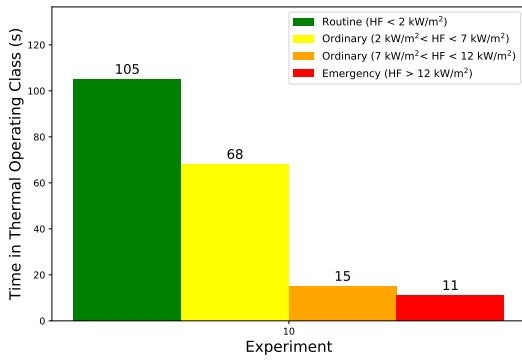

(a) Nozzle Firefighter Helmet

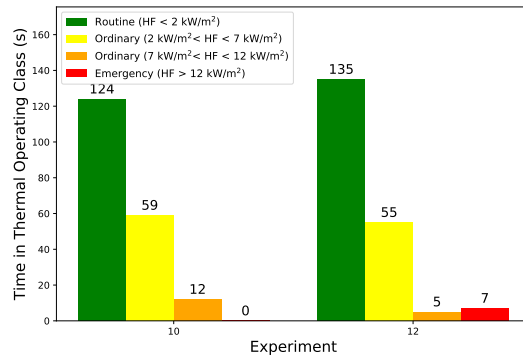

(b) Engine Officer Helmet

Figure 4.17: Time spent in each thermal operating class according to heat flux criteria for Method 3 Experiments where helmet data was recorded. Green indicates routine operating class ($HF < 2 \text{ kW/m}^2$). Yellow indicates lower half of ordinary operating class ($2 \text{ kW/m}^2 < HF < 7 \text{ kW/m}^2$). Orange indicates upper half of ordinary operating class ($7 \text{ kW/m}^2 < HF < 12 \text{ kW/m}^2$). Red indicates emergency operating class ($HF > 12 \text{ kW/m}^2$).

4.5 Method 4 Effect of a Failed Ceiling on Initial Exterior Suppression of a Second Floor Bedroom Fire

Two experiments (Experiments 13 and 14) were conducted to investigate the effectiveness of exterior water application into a second-floor, fire compartment after a ceiling failure. Each experiment employed two different exterior water application techniques into the fire room (bedroom). The first exterior water stream was aimed into the fire compartment and through the failed ceiling. The second exterior water stream was aimed at the window lintel (top of the window frame). The two techniques were used to compare options for dispersing water into a fire compartment when a ceiling failure has occurred. This expanded upon the tactical consideration published in the Impact of Interior and Exterior Fire Attack [4].

Although these two experiments were designed to investigate the same exterior water application, it is important to note the differences between the experiments. Experiment 13 was conducted in the structure located at 1492 Dayton Xenia Rd, Beavercreek, OH, while Experiment 14 was conducted in 1030 Hilltop Rd, Beavercreek, OH. The structures differed in building geometry, ceiling height, and interior volume. These factors influence the fire dynamics, specifically smoke and heat transport. A structural difference of noteworthy importance for these experiments was the direction of the rafters in the attic space located above the failed ceiling. The structure located at 1492 Dayton Xenia Rd. had rafters that ran perpendicular to the the direction of the hose-line stream during exterior water application and acted as an obstruction. The structure located at 1030 Hilltop Rd. had rafters that ran parallel to the direction of the hose-line stream. Following the noticeable impact of the presence of the rafters in Experiment 13, the rafters were removed in the area of the failed ceiling for Experiment 14.

An overview of the events occurring in each structure are presented in Table 4.19.

Table 4.19: Coordinated Method 4 Intervention Times

Intervention	Experiment	
	13	14
Ignition	00:00	00:00
Ceiling Failure	06:00	06:01
Exterior Water Flow - Ceiling	07:00	07:01
Exterior Water Flow - Lintel	12:00	09:02
Front Door Open	12:31	09:42
Suppression Crew Enters	13:32	10:10
Interior Water Flow	13:45	10:36

Gas sample points and skin burn assessment packages were placed at two locations in Experiments 13 and 14. In Experiment 13, these occupant locations were located in the hallway just outside the fire room (bedroom 2) and in a remote bedroom (bedroom 1). In Experiment 14, oc-

cupant packages were located in the hallway, immediately outside the fire room, and in the flex space. Skin burn assessment packages and gas sample points were located 1 ft above the floor in each of these locations. Additionally, gas concentrations were measured 3 ft above the floor in the hallway in Experiment 13 and in the flex space in Experiment 14. Table 4.20 lists these occupant locations, their location with respect to the flow path established after the front door was opened, and their distance from the fire room doorway. Note: The occupant package closest to the fire room (hallway in Experiments 13 and 14) were a comparable distance away from the fire room, while the remote occupant in Experiment 14 (flex space) was considerably farther than its counterpart in Experiment 13 (bedroom 1). Figure 4.18 summarizes the fire floor layouts for each experiment in Method 4.

Table 4.20: Coordinated Method 4 Occupant Tenability Assessment Package Locations

Exp #	Location in Structure	Location with Respect to Flow Path	Distance (ft) from Fire Room
13	Bedroom 1	Remote	18.0
	Hallway	Inside	9.1
14	Flex Space	Remote	34.3
	Hallway	Inside	6.9

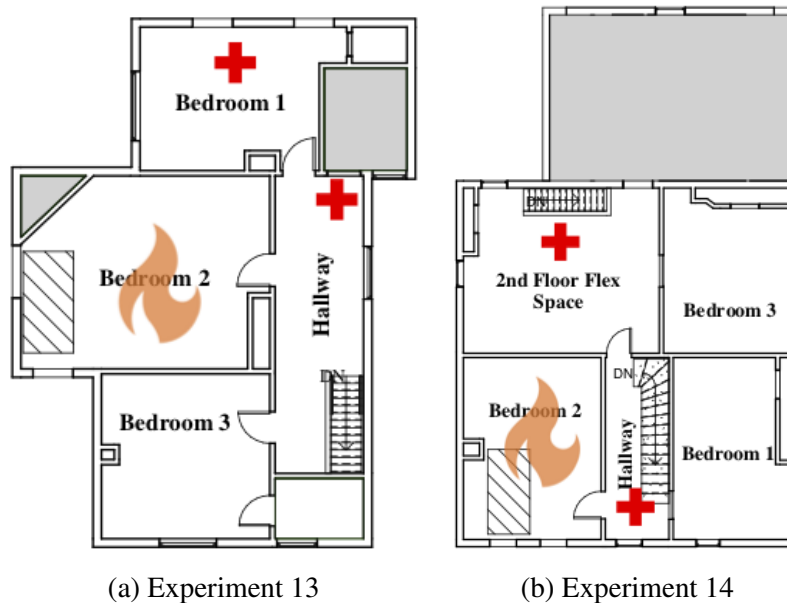

Figure 4.18: Fire floor layouts for acquired structures used in Method 4 experiments. The red crosses represent the approximate locations of the occupant assessment packages. The gray areas were isolated from the remainder of the structure and utilized as space for instrumentation.

4.5.1 Suppression and Ventilation Tactics

In both Experiments 13 and 14, the bedroom fire was in a post-flashover state for approximately 150 s prior to the initial exterior water application. In each experiment, the nozzle firefighter was advised to use a straight stream pattern directed at a steep angle through the fire room window into the hole created by the missing portion of the ceiling. This initial suppression action lasted for 10 s. The fire was then allowed to regrow and a second exterior suppression action was performed, where a straight stream was directed off the window header, breaking up the stream and distributing it over the fuel (lintel hit).

The fire room temperature and pressure data presented in Sections 3.13 and 3.14 indicated the initial, straight stream suppression action was more effective at reducing fire room temperatures in Experiment 13 than in Experiment 14. Figure 4.19 shows the temperatures in the fire room and the space immediately adjacent (hallway in Experiments 13 and 14) from the time of the initial exterior straight stream suppression through final fire room suppression. In Experiment 13, the straight stream application reduced fire room temperatures from between 1950 °F and 1600 °F to between 800 °F and 700 °F over a period of approximately 45 s. In this case, the straight stream interacted with the rafters running through the failed ceiling, leading to a partially broken stream.

Approximately 30 s after the end of the initial exterior suppression action, temperatures in the fire room subsequently increased until the lintel hit was initiated, which dropped temperatures from 1450 °F to about 180 °F. Although temperatures dropped in the fire room, there was not a noticeable change in the hallway as a result of the initial application, as shown in Figure 4.19b. In Experiment 14, temperatures dropped slightly after the straight stream through the failed ceiling, but began to increase approximately 20 s after the nozzle was shut down, rebounding to peak temperatures uniformly in excess of 1750 °F prior to the start of the lintel hit. The lintel hit dropped temperatures from over 1650 °F to 1350 °F by the time the front door was opened. Similar to Experiment 13, the temperatures in the hallway outside the fire room doorway remained steady in the period between the two suppression actions.

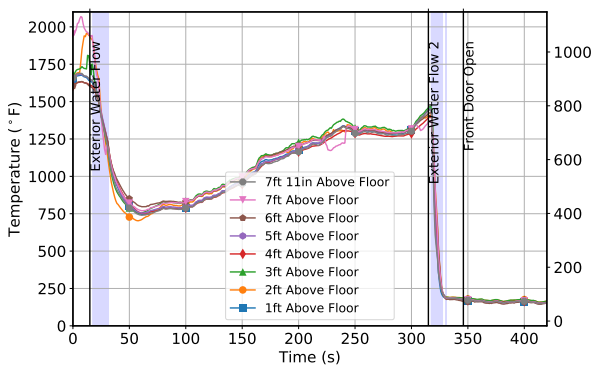

(a) Experiment 13 Fire Room

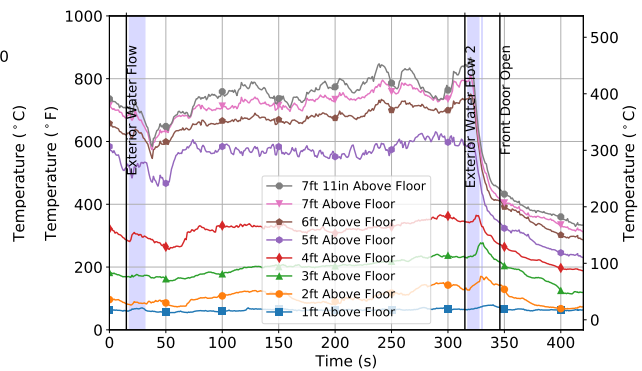

(b) Experiment 13 Hallway

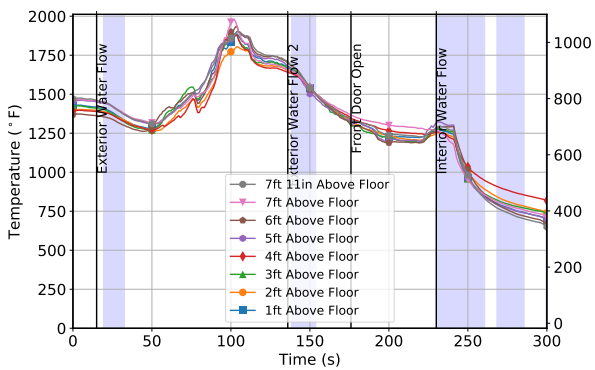

(c) Experiment 14 Fire Room

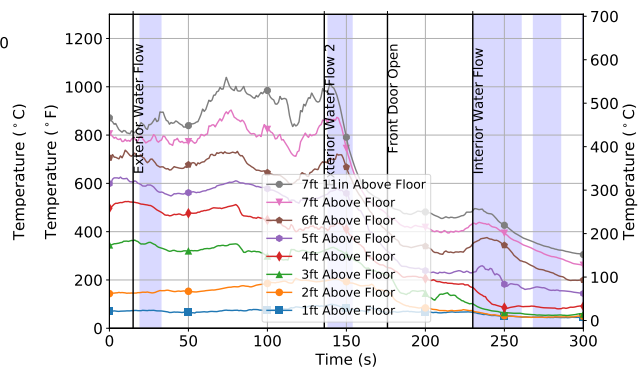

(d) Experiment 14 Hallway

Figure 4.19: Effect of suppression actions on fire room temperatures and hallway temperatures in Method 4 experiments. Time = 0 corresponds to the beginning of the straight stream suppression action and data is included through the opening of the front door and the initial interior suppression actions.

Visually, the initial straight stream application may appear to be more effective at reducing temperatures in the fire room than it actually was. Figures 4.20 and 4.21 show still images from the video camera worn by the suppression firefighter and an infrared camera with a view of the steep angle water application for Experiments 13 and 14, respectively. The timing of the images are one second prior to water application, at the point when the hoseline was shut down, 5 s post shutdown and 10 s post shutdown. Immediately after shutdown, there was no fire visible in either window. This may give the impression that the steep angle straight stream through the failed ceiling extinguished the fire. Within 10 s, however, fire was again visible through the window. Additionally, following the water flow, the IR camera shows little change in the heat signature at the window adjacent to where the water was applied.

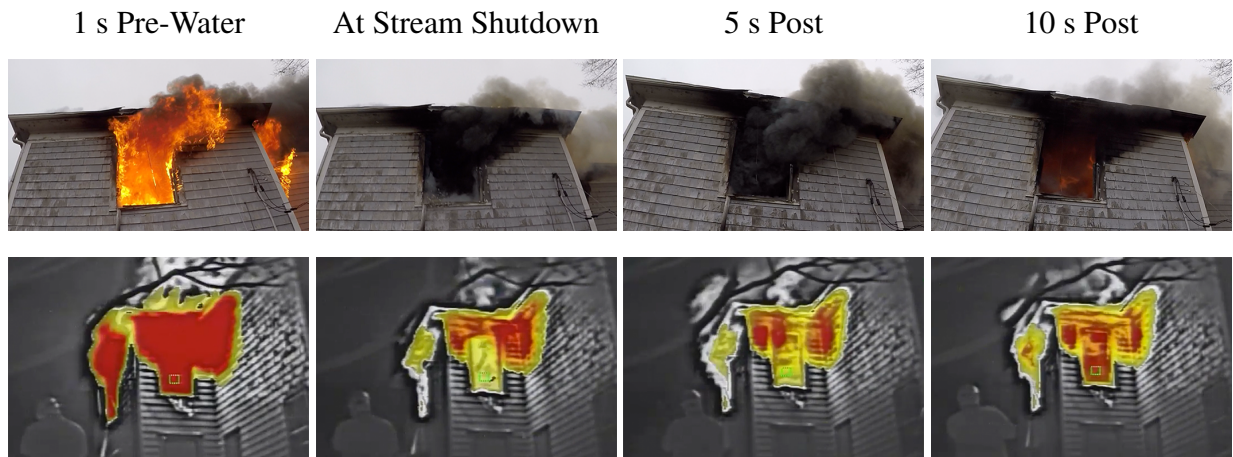

Figure 4.20: Visual representation of the effect of the initial water application on the fire room where the ceiling has failed for Experiment 13. Standard video from firefighters helmet on the B side (top), and infrared video from the A/B corner (bottom). The columns are 1 s prior to water application (left) at the point the stream was shut down (left middle), 5 s post water application (right middle), and 10 s post water application (right).

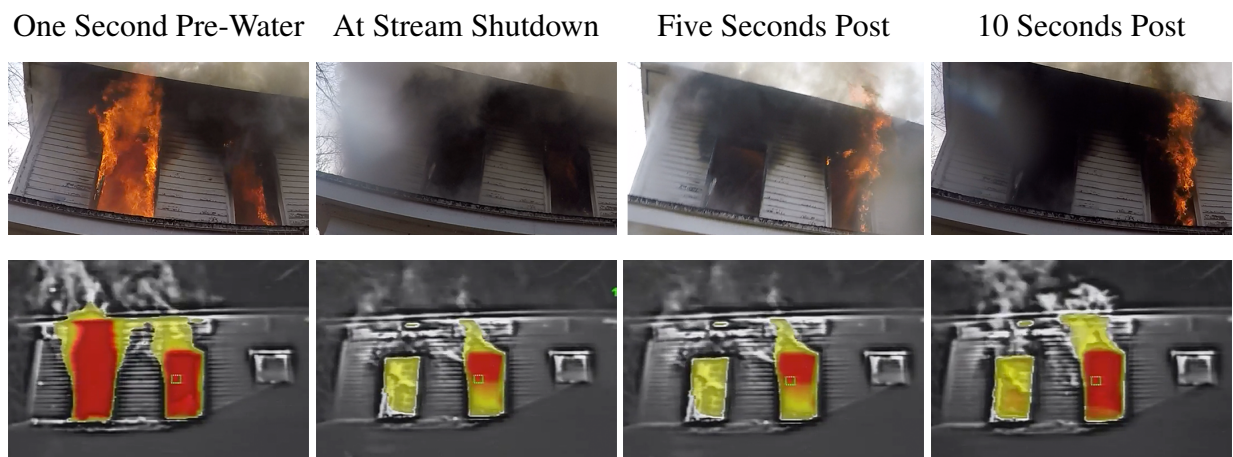

Figure 4.21: Visual representation of the effect of the initial water application on the fire room where the ceiling has failed for Experiment 14. Standard video from firefighters helmet from the A side (top), and infrared video from the A side (bottom). The columns are 1 s prior to water application (left) at the point the stream was shut down (left middle), 5 s post water application (Right Middle), and 10 s post water application (right).

The fire room and hallway temperature data indicated the lintel hit was more effective than the straight stream in both Experiment 13 and Experiment 14. In Experiment 13, the lintel hit uniformly dropped temperatures to less than 200 °F. Additionally, it reduced hallway temperatures to below 500 °F by the time the front door was opened. In Experiment 14, the fire room temperature decrease due to the lintel hit was more gradual, but the hallway temperatures similarly drop to below 500 °F by the time the front door was opened.

In a similar fashion to the straight stream steep angle suppression, the lintel hit resulted in the complete reduction of visible fire in both windows. The change in the infrared camera view, however, was different than after the straight stream, steep angle suppression. Figure 4.22 and 4.23 show the standard and infrared camera views for Experiments 13 and 14, respectively. The nozzle firefighter began to transition to the compartment immediately after application which resulted in a lack of standard camera footage at that position for the five and ten seconds post water application. The infrared camera was stationary and shows that in the window adjacent to where water was applied there was a more pronounced change between pre- and post-water application than the initial steep angle application, where little to no change in the heat signature was observed.

A limitation of the comparison between the straight stream, steep angle suppression and the lintel hit is that in both experiments, the straight stream, steep angle suppression was the initial suppression action. Further research should consider the effectiveness of opposite scenario, with the lintel hit conducted as the initial suppression action.

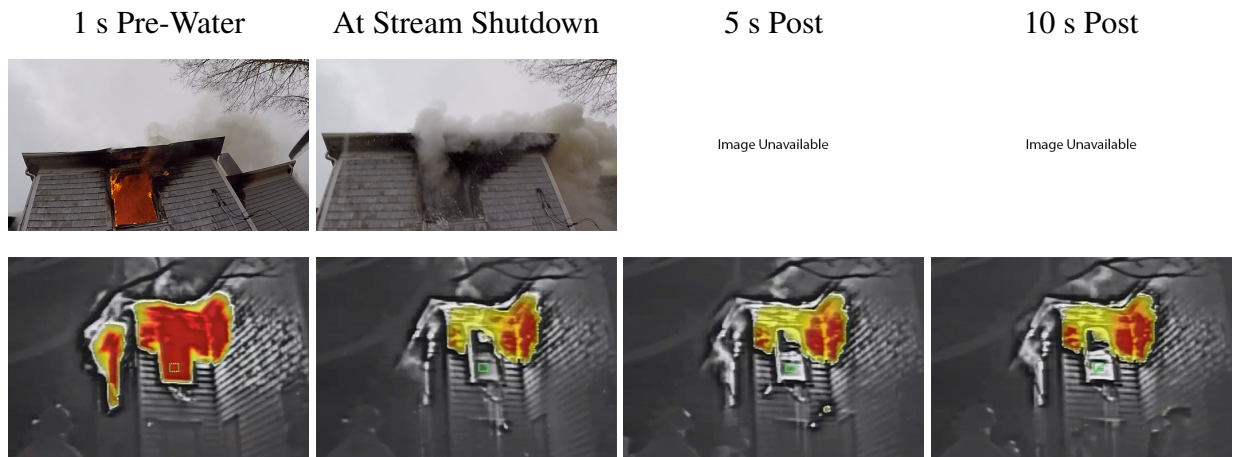

Figure 4.22: Visual representation of the effect of water application using a lintel suppression for Experiment 13. Standard video from firefighters helmet (top), and infrared video from A/B corner (bottom). The columns are 1 s prior to water application (left) at the point the stream was shut down (left middle), 5 s post water application (right middle), and 10 s post water application (Right).



Figure 4.23: Visual representation of the effect of water application using a lintel suppression for Experiment 14. Standard video from firefighters helmet (Top), and infrared video from A/B corner (Bottom). The columns are 1 s prior to water application (left) at the point the stream was shut down (left middle), 5 s post water application (right middle), and 10 s post water application (right).

4.5.2 Occupant Tenability Estimate

As described in Sections 3.13 and 3.14, O_2 concentrations started to decrease and CO and CO_2 concentrations started to increase in the fire room as these experiments transitioned through flashover. Table 4.21 lists the FED at the time of the initial exterior suppression action, the FED at the end of the experiment, and the time from the initial suppression action to the peak FER and time at which the CO concentration drops below 0.12% (1200 ppm).

Table 4.21: Coordinated Method 4 Occupant Tenability Estimate

Exp	Occupant Location	FED at Ext. Suppression	Final FED	Time* to Peak FER [s]	CO at Ext. Suppression [ppm]	Time* to CO < 1200 ppm [s]
13	Bedroom 1 ft	0.5	85	200	10900	861
	Hallway 1 ft	0.1	6.5	160	3000	613
	Hallway 3 ft	3.0	120.5	179	14900	920
14	Flex Space 1 ft	0.2	0.9	65	+	206
	Flex Space 3 ft	3.0	66	98	3100	354
	Hallway 1 ft	0.0	0.0	169	16900	171

* Times are expressed as time elapsed after the initial fire department intervention (initial exterior suppression)

+ indicates CO concentrations below measurement error

Although the temperature profiles and visual cues indicated the initial straight stream suppression

into the failed ceiling had an effect on the fire, this was not reflected in the gas concentration data. The FER for Experiments 13 and 14, shown in Figure 4.24, was not noticeably affected by initial suppression, and continued to increase during the period between the first exterior suppression (straight stream) and second exterior suppression (lintel hit) in both Experiments 13 and 14. The lintel hit, on the other hand, was more effective at decreasing FER. Following the lintel hit and subsequent front door open, the FER decreased to negligible values.

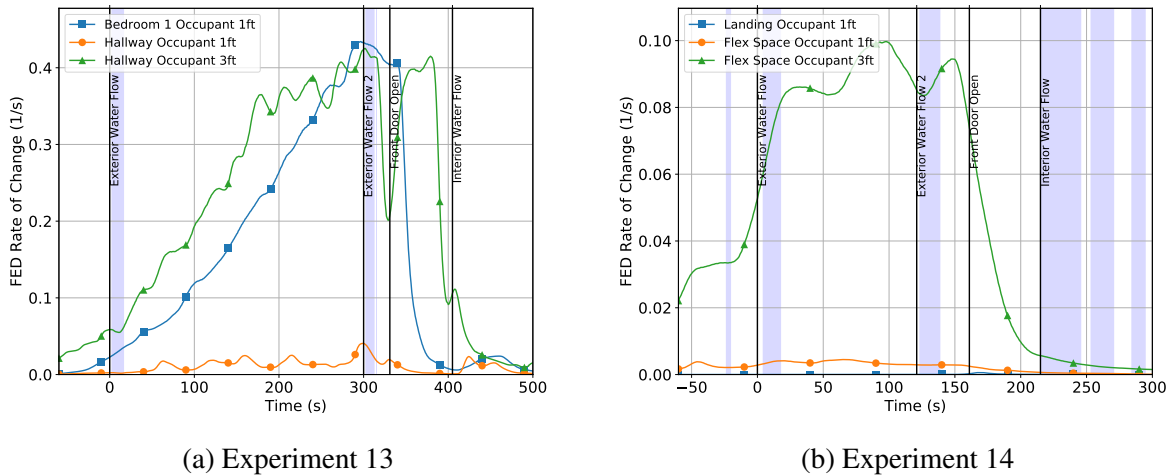

Figure 4.24: Fractional Effective Rate (FER) for Method 4 Experiments. Time = 0 corresponds to exterior suppression.

The sustained period of elevated CO concentrations (see Table 4.21) resulted in high FED values at the end of each experiment. For these experiments, it is important to recognize that following the initial exterior water application, the fire was allowed to recover versus having the suppression crew transition to interior suppression. As a result, the high cumulative effect of gas concentration (FED) is as much a product of the long experiment duration combined with the lack of additional ventilation as it is an indication of the effectiveness of the exterior suppression.

The skin burn assessment data followed a similar trend to the gas concentration data in terms of benefit provided by exterior suppression actions with a failed ceiling. Figure 4.25 shows the surface, subdermal, and local temperatures for the occupant package located closest to the fire room doorway in each experiment. The temperature data shows that the initial straight stream application into the failed ceiling hole had little to no effect on the surface or subdermal temperatures, which continued to increase for the duration of the period between the straight stream application and lintel hit. The lintel hit, on the other hand, resulted in an immediate surface temperature decrease in both experiments. As the front door was opened and interior suppression continued, surface and subdermal temperatures continued to decrease.

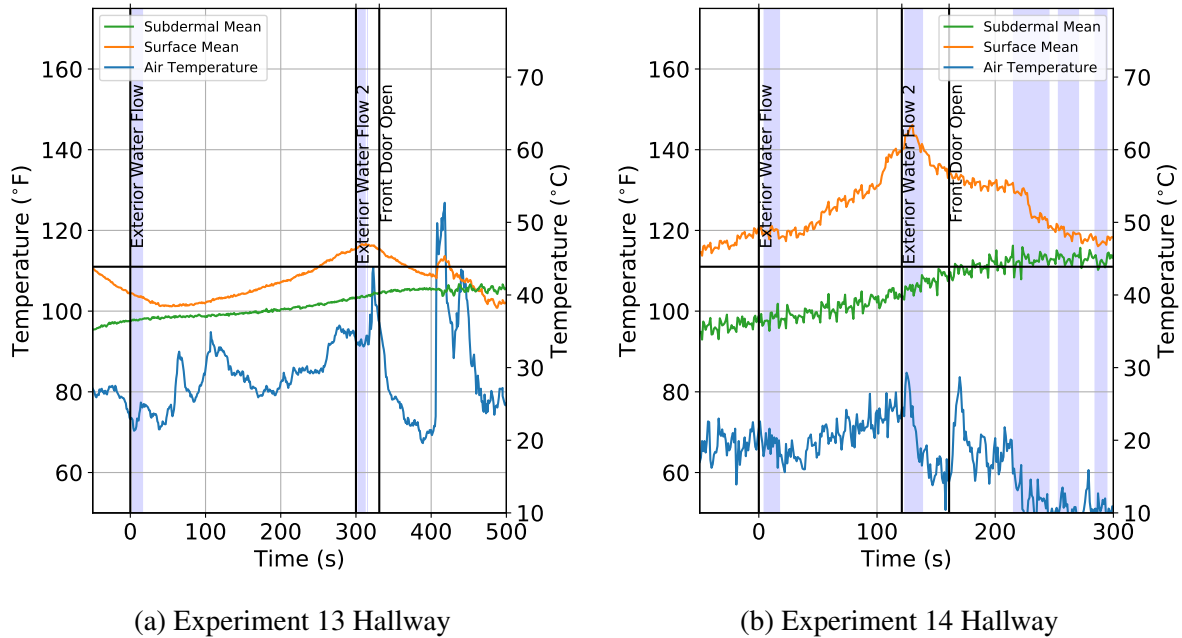

Figure 4.25: Effect of exterior suppression actions on skin burn assessment measurements in Experiments 13 and 14. Time = 0 corresponds to the start of the initial exterior suppression action.

Table 4.22 summarizes the peak temperatures for the skin burn assessment packages at the occupant locations. The highest peak temperatures between the two Method 4 experiments were observed in the occupant packages that were closest to the fire room—the hallway in Experiments 13 and 14. In these locations, the peak surface temperature exceeded 111 °F (44 °C), the minimum threshold for thermal injury. In both experiments, this threshold was met shortly after the time of flashover. The subdermal temperatures at the near occupant location in Experiment 14 also exceeded 111 °F (44 °C), reaching a peak shortly after the lintel hit. The subdermal temperatures did not exceed 111 °F (44 °C) in Experiment 13, although Figure 4.25a shows that a similar local peak occurred in the temperature data as was noted in the gas concentration data 832 seconds after ignition (412 seconds after initial exterior flow) corresponding to interior suppression.

Table 4.22: Coordinated Method 4 Pig Skin Temperatures

Exp	Location	Surface Temperature		Subdermal Temperature	
		Time to 111 °F [s]	Peak [°F]	Time to 44 °F [s]	Peak [°F]
13	Bedroom 1	290	118	-	107
	Hallway	-	84	-	98
14	Flex Space	-	92	-	91
	Hallway	246	149	587	116

- indicates value not reached during experiment

As distance from the fire room increased, the peak temperatures decreased. At the Bedroom 1 location in Experiment 13 and the flex space location in Experiment 14, neither the surface nor subdermal temperatures exceeded 111 °F (44 °C) over the course of the experiment.

In Experiments 13 and 14, the second exterior suppression action, the lintel hit, was more effective at reducing the rates of toxic exposure and surface and subdermal temperature rise than the initial exterior suppression action of a straight stream through a failed ceiling. Although this initial suppression resulted in the reduction of fire room temperatures and visible fire in the fire room windows, little benefit was noted at the occupant locations outside the fire room.

4.5.3 Firefighter Helmet Thermal Exposure

Heat flux data was collected for the nozzle firefighter and officer positions in Experiment 14. Table 4.23 lists the peak heat fluxes and total energy exposures for the nozzle and officer positions in Experiment 14.

Table 4.23: Thermal Exposure to Nozzle and Officer Firefighter Helmets – Method 4

Nozzle Firefighter						
Exp / Ventilation	Temperature [°F]		Vertical Heat Flux [kW/m ²] [kJ/m ²]		Horizontal Heat Flux [kW/m ²] [kJ/m ²]	
	$\mu \pm \sigma$	Peak	Peak	Total Energy	Peak	Total Energy
14	-	-	-	-	10.2	621
Officer						
Exp / Ventilation	Temperature [°F]		Vertical Heat Flux [kW/m ²] [kJ/m ²]		Horizontal Heat Flux [kW/m ²] [kJ/m ²]	
	$\mu \pm \sigma$	Peak	Peak	Total Energy	Peak	Total Energy
14	-	-	7.3	786	5.0	536

The nozzle firefighter experienced a peak horizontal heat flux of 10.2 kW/m², which is higher than the peak heat flux experienced by the officer position, which was 7.3 kW/m². These peak exposures were experienced as the suppression crew reached the fire room doorway and began interior suppression. After the peak, heat flux quickly decreased as suppression continued. The peak exposures in Experiment 14 are consistent with ordinary thermal operating conditions, as shown in Figure 4.26.

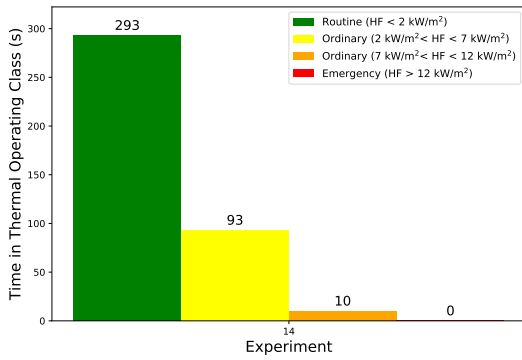

(a) Nozzle Firefighter Helmet

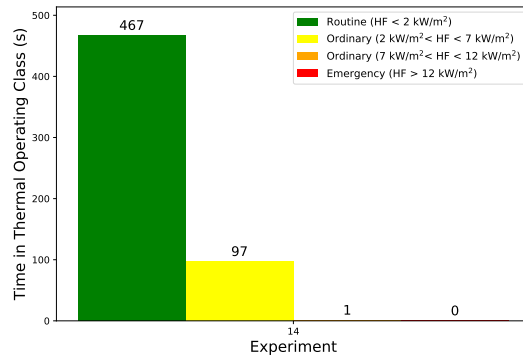

(b) Engine Officer Helmet

Figure 4.26: Time spent in each thermal operating class according to heat flux criteria for Method 4 Experiments where helmet data was recorded. Green indicates routine operating class ($HF < 2 \text{ kW/m}^2$). Yellow indicates lower half of ordinary operating class ($2 \text{ kW/m}^2 < HF < 7 \text{ kW/m}^2$). Orange indicates upper half of ordinary operating class ($7 \text{ kW/m}^2 < HF < 12 \text{ kW/m}^2$). Red indicates emergency operating class ($HF > 12 \text{ kW/m}^2$).

4.6 Method 5, First Floor Kitchen Fire - Interior Suppression Post Ventilation

Method 5 included three experiments designed to evaluate the effectiveness of ventilation prior to interior suppression on a first-floor kitchen fire. The first experiment (Experiment 15) was intended to be a baseline experiment for Coordination Method 5. During this experiment no additional ventilation occurred other than the opening of the front door to allow access for the suppression crew. The second and third experiments provided the opportunity to evaluate horizontal ventilation (Experiment 16) and positive pressure (Experiment 17). Each experiment was conducted in a different structure, with varying ceiling heights, interior volumes, and floor plans. Experiment 15 was conducted in a 1.5 story structure at 775 Hilltop Rd., Experiment 16 was conducted in a 1-story structure at 773 Hilltop Rd., and Experiment 17 was conducted in a 2-story structure at 230 N. Walnut Rd. Experiments 15 and 16 were conducted in structures with ceiling heights of approximately 8 ft and internal areas of approximately 1,200 ft², while Experiment 17 was conducted in a structure with a ceiling height of approximately 10 ft and internal area of approximately 2,100 ft².

Each kitchen fire was allowed to grow to a steady post-flashover state before the front door was opened. The timing to reach flashover and initiate fire department intervention varied between 6:00 and 13:01 (300 s and 781 s). In Experiments 16 and 17, ventilation was initiated approximately 10 s after the front door was opened, and the suppression crew entered the structure approximately 10 s later. The crew then advanced to the kitchen and began interior suppression using either a flow and move (Experiment 16) or shutdown and move method (Experiment 15 and 17). Table 4.24 documents the times at which various interventions occurred for Method 5.

Table 4.24: Coordinated Method 5 Intervention Times

Intervention	Experiment		
	15	16	17
Ignition	00:00	00:00	00:00
Front Door Open	06:00	10:00	13:01
Horizontal Ventilation	—	10:11	—
Positive Pressure Ventilation	—	—	13:11
Suppression Crew Enters Structure	06:11	10:23	13:23
Initial Water Into Kitchen	06:29	10:26	14:11
Suppression Crew Entered Fire Room	07:16	12:08	14:29

Table 4.25 lists the relative distance from the fire room to the occupant packages location, along with their distance from the fire room doorway. In each of the experiments, an occupant package was placed in the dining room, between the front door and the kitchen. In Experiments 15 and 17, the second occupant package was placed on the floor above the kitchen. In Experiment 15, the remote occupant package was in a bedroom in the half-story of the structure, connected to the kitchen by a staircase. In Experiment 17, the remote occupant package was at the top of

the stairs, located close to the front door. In Experiment 16, the remote occupant package was located in a bedroom, adjacent to the flow path between the front door and the kitchen. At each of these occupant locations, skin burn assessment packages were located 1 ft above the floor, which recorded surface, subdermal, and local air temperatures. Additionally, gas concentrations were monitored 1 ft and 3 ft above the floor in the dining room in Experiments 15 and 16 and in the hallway in Experiment 17 and 1 ft above the floor in the remote bedroom in Experiments 15 and 16 and in the dining room in Experiment 17. Figure 4.27 summarizes the fire floor layouts for each experiment in Method 5.

Table 4.25: Coordinated Method 5 Occupant Tenability Assessment Package Locations

Exp #	Location in Structure	Location with Respect to Flow Path	Distance (ft) from Fire Room
15	Bedroom 3	Remote	19.5
	Dining Room	Inside	13.9
16	Bedroom 1	Remote	29.8
	Dining Room	Inside	16.5
17	Hallway	Remote	85.3
	Dining Room	Inside	15.4

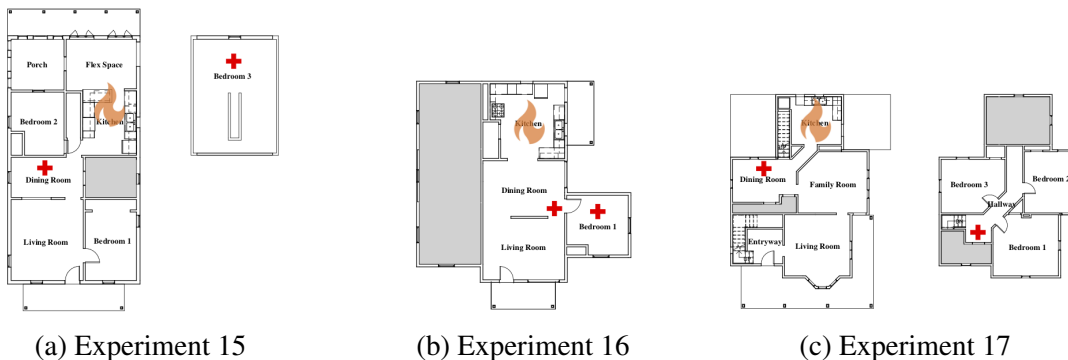

Figure 4.27: Fire floor layouts for acquired structures used in Method 5 experiments. The red crosses represent the approximate locations of the occupant assessment packages. The gray areas were isolated from the remainder of the structure and utilized as space for instrumentation.

Table 4.25 shows the impact of structure geometry on occupant package location. The average distance away from the fire room for the remote occupant package was 44 ft with a standard deviation of 29 ft. For the occupant package inside the flow path, the average distance was shorter, at 15 ft, with a standard deviation of 1 ft. The small standard deviation relative to the mean value for the flow path occupant package indicates similarly spaced instrumentation packages for these experiments. For the remote occupant packages, the larger standard deviation indicates, independent of tactics examined, the distance from fire room may play a role in occupant data variability.

4.6.1 Suppression and Ventilation Tactics

In each experiment, the initial ventilation action was to open the front door to gain access into the structure. This ventilation action was followed by additional ventilation from side A of the structure in Experiments 16 and 17. Suppression actions followed after entrance into the structure. The sequence of events in each experiment was similar but structure geometry and floor plan affected the time between events. Table 4.26 documents the time from initial ventilation of the front door to various ventilation and suppression events.

Table 4.26: Coordinated Method 5 Tactic Duration and Times to Water Flow

	Experiment		
	15	16	17
Time from front door open to ventilation (s)	-	11	10
Time from front door open to structure entry (s)	11	23	22
Time from front door open to first water flow (s)	18	26	70
Time from front door open to flow in fire room doorway (s)	29	42	70
Time from front door open to fire room entry (s)	75	128	88

Fire room temperatures within each experiment began increasing between 7 s and 10 s post front door ventilation before any additional ventilation was provided. Figure 4.28 documents the kitchen temperature variations post front door ventilation for each experiment in Method 5. In Experiment 16, kitchen temperatures initially dropped following the front door open ($t = 0$ s in Figure 4.28b) and began to increase in the 5 s prior to horizontal ventilation. The opening of the windows resulted in an approximate 150 °F temperature rise in the fire room before suppression began. Experiment 17 kitchen temperatures (see Figure 4.28c) indicated positive pressure ventilation initially improved conditions within the fire room, as temperatures decreased for approximately 27 s. Subsequently, temperatures at 3 ft and 4 ft above the floor began to increase and above 4 ft the temperatures recovered to pre-ventilation magnitudes prior to the start of suppression.

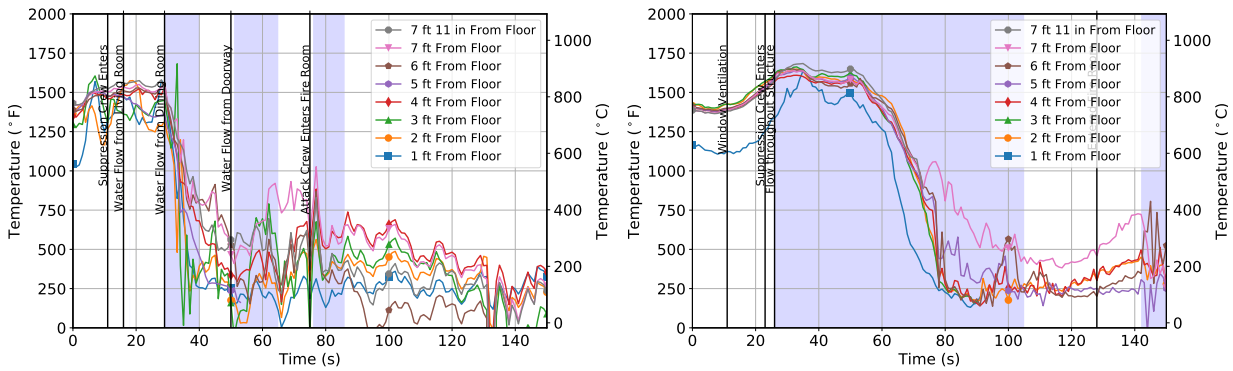

(a) Experiment 15 Fire Room Temperatures

(b) Experiment 16 Fire Room Temperatures

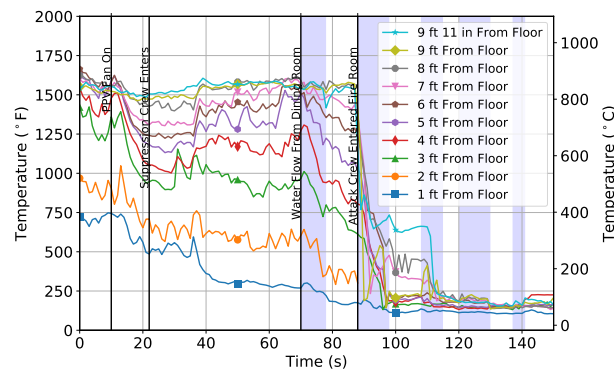

(c) Experiment 17 Fire Room Temperatures

Figure 4.28: Suppression/Ventilation effects on fire room temperatures for Method 5 experiments. Time = 0 corresponds to the front door being opened and data is included for 150 s after the initial fire department intervention.

During Experiments 15 and 17 the nozzle firefighter employed a “shutdown and move” method of hoseline advancement while the nozzle firefighter in Experiment 16 employed a “flow and move” method of hoseline advancement. Differences in floor plan among the three experiments resulted in different times required to advance to the fire room. In Experiment 15, the dining room suppression action was able to apply water into the fire room, reducing temperatures prior to final suppression in the kitchen doorway. In Experiment 16, the flow-and-move suppression also began from the dining room, but the hose stream was directed into the dining room wall, rather than the fire room, for the first 26 s of suppression. Once the stream was directed into the kitchen, temperatures began to decrease substantially. Similarly, the dining room suppression in Experiment 17 was directed at the wall, and did not result in a significant temperature decrease. Once the suppression crew advanced to the kitchen doorway and into the kitchen itself, temperatures decreased.

Temperature data from the dining room, which was on the inlet side of the flow path established after the front door was opened, is presented in Figure 4.29. In each of the experiments, temperatures close to the floor (approximately 4 ft and below) began to decrease as fresh air was entrained

along the flow path from the front door to the kitchen. This decrease was most pronounced in Experiment 17, after the activation of the PPV fan, at which point temperatures at all elevations began to decrease in the dining room in the period leading up to suppression. On the contrary, in Experiments 15 and 16, temperatures closer to the ceiling were not notably affected by front door ventilation.

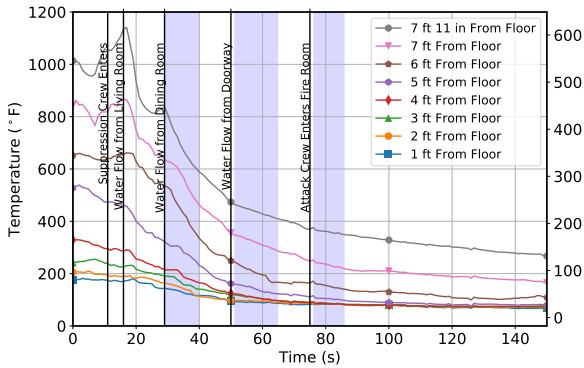

(a) Experiment 15 Dining Room Temperatures

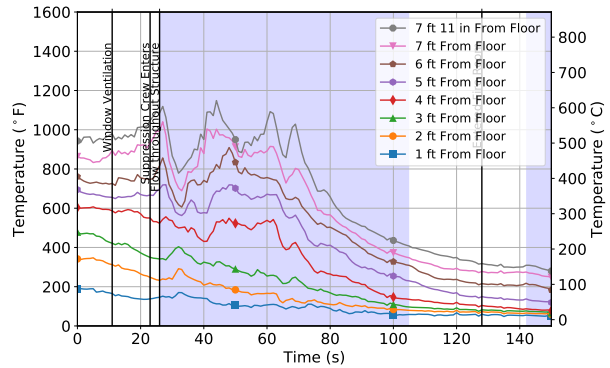

(b) Experiment 16 Dining Room Temperatures

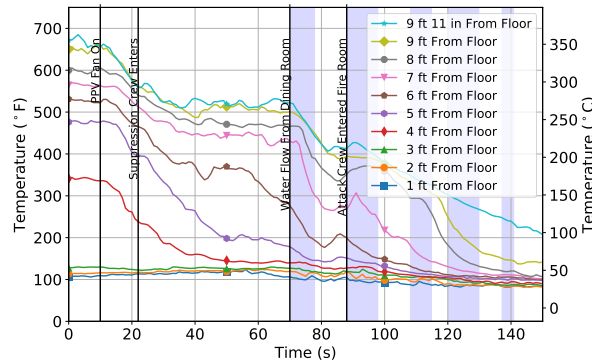

(c) Experiment 17 Dining Room Temperatures

Figure 4.29: Suppression effects on remote room temperatures for Method 5 experiments. Time = 0 corresponds to the front door being opened and data is included for 150 s after fire department intervention.

Suppression efforts were effective at reducing temperatures at all elevations in the adjacent space to the fire room. During Experiment 15 (see Figure 4.29a), the suppression from the living room and the approximately 30 gal flow from the dining room reduced temperatures toward pre-ignition conditions. In Experiment 16, the flow and move tactic did not efficiently reduce temperatures in the dining room until the stream was directed into the fire room approximately 26 s after the start of the flow. This is partially because the initial suppression efforts were ineffective at applying water into the kitchen, and partially because the dining room and kitchen were essentially one open space, meaning that once suppression was effective in the kitchen, temperatures also dropped in the dining room. Similarly, in Experiment 17 the dining room suppression action resulted in minimal temperature change, since the stream was directed at the wall between the kitchen and

dining room. Dining room temperatures continued to decrease in this experiment as suppression was initiated from the kitchen doorway.

4.6.2 Occupant Tenability Estimate

Table 4.27 summarizes the FED value at the time of the first fire department intervention, the final FED at the end of the experiment, and the time elapsed from the opening of the front door to the peak FER and time the CO concentrations dropped below 0.12% (1200 ppm).

At the time of front door ventilation, FED values at the 1 ft elevation were lower than FED values at the 3 ft elevation on the fire floor. In each of the experiments, the remote occupant had a lower toxic dose than the dining room occupant location, which was closer to the fire. In Experiments 15 and 17, these remote occupant locations were located on the floor above the fire. The lower FED values at the time of intervention for floors above the fire compared to those of occupants on the fire floor, indicate that smoke filling the upstairs had diluted and cooled more than the smoke in the dining room. In general during Coordination Method 5, the closer to the fire room and the higher in elevation within the room that the occupant package was located, the higher the toxic FED by the end of the experiment, even when comparing occupant packages on the same floor as the fire versus occupants on the floor above the fire.

Table 4.27: Coordinated Method 5 Occupant Tenability Estimate

Exp	Occupant Location	FED at Front Door Open	Final FED	Time* to Peak FER [s]	CO at Front Door Open [ppm]	Time* to CO < 1200 ppm [s]
15	Bedroom 3 1 ft	0.03	0.22	76	1000	116
	Dining Room 1 ft	0.13	0.48	36	3100	91
	Dining Room 3 ft	0.60	1.27	9	9300	78
16	Bedroom 1 1 ft	0.02	0.05	+	+	+
	Dining Room 1 ft	0.16	0.25	17	2100	50
	Dining Room 3 ft	0.42	0.95	23	5700	110
17	Hallway 1 ft	0.08	0.28	54	1400	121
	Hallway 3 ft	0.39	0.77	29	5100	97
	Dining Room 1 ft	0.40	1.31	67	4300	179

* Times are expressed as time elapsed after the initial fire department intervention (front door open)
 + indicates CO concentrations below measurement error

For each experiment in Method 5, ventilation caused conditions nearest to the fire location to improve between 9 and 67 seconds after front door opening. Ventilation of the front door in Experiment 15 and the front door and window in Experiment 16 resulted in a peak FER within 36 s of intervention. The benefit of the entrained air from ventilation on the side A in these two experiments was not as immediate for the remote occupant locations, which in each case were not

directly in the flow path. In Experiment 17, ventilation of the front door and introduction of the PPV fan improved conditions at both elevations for the second-floor hallway occupant location, with the FER beginning to decrease less than 60 s after the opening of the front door, but increased the FER along the flow path from the front door to the kitchen. The improvement in conditions at the second floor occupant location may possibly be a result of leakage in the structure. Conditions in the dining room did not begin to improve until the dining room suppression action.

Skin burn assessment packages were co-located with the gas measurement points at the occupant locations. Table 4.28 displays the average surface and subdermal pig skin temperatures at each occupant package for Method 5. In Experiment 15, surface temperatures at both occupant packages exceeded 111 °F, the minimum threshold for thermal injury, prior to fire department intervention. The remote bedroom occupant, located on the floor above the fire floor, experienced a higher peak surface temperature than the dining room occupant. In addition, the subdermal temperature at this location exceeded 111 °F, indicating the possibility for deeper thickness burns. While surface temperatures at the dining room occupant began to decrease shortly after the opening of the front door, the surface temperatures for the occupant on the floor above the fire did not start to decrease until the onset of suppression. The peak surface temperatures observed in Experiment 16 were the lowest of the three experiments, with none of the surface temperatures exceeding 111 °F. Following ventilation of the front door and living room window, these temperatures decreased for the remainder of the experiment. Similar to the dining room occupant in Experiment 15, the dining room occupant in Experiment 17 sustained high peak surface and subdermal temperatures, due to the proximity to the fire room, which decreased following the activation of the PPV fan. Unlike in Experiment 15, the occupant location on the floor above the fire experienced negligible temperature rise. The difference in behavior for the occupant on the floor above the fire is due to both the high ceilings in the structure in Experiment 17 and the difference in stairway location between the two experiments. In Experiment 15, the stairway was located directly next to the kitchen, and hot gases were able to fill the remote bedroom as the kitchen transitioned through flashover. In Experiment 17, on the other hand, the stairway was located next to the front door, and gases had to travel a substantially farther distance to reach the occupant package on the floor above the fire.

Table 4.28: Coordinated Method 5 Pig Skin Temperatures

Exp	Location	Surface Temperature		Subdermal Temperature	
		Time to 111 °F [s]	Peak [°F]	Time to 111 °F [s]	Peak [°F]
15	Bedroom 3	283	172	389	129
	Dining Room	299	124	-	102
16	Bedroom 1	-	105	-	99
	Dining Room	-	91	-	69
17	Hallway	-	88	-	89
	Dining Room	615	139	673	128

- indicates value not reached during experiment

4.6.3 Firefighter Helmet Thermal Exposure

Heat flux measurements were recorded for the officer position for all three Method 5 experiments, while temperature was also recorded for Experiments 16 and 17. The results, including the peak temperatures and heat fluxes, the temperature average and standard deviation, and the total energy exposure in both the horizontal and vertical directions, are shown in Table 4.29.

Table 4.29: Thermal Exposure to Nozzle and Officer Firefighter Helmets – Method 5

Experiment	Officer					
	Temperature °F		Vertical Heat Flux kW/m ² kJ/m ²		Horizontal Heat Flux kW/m ² kJ/m ²	
	$\mu \pm \sigma$	Peak	Peak	Total Energy	Peak	Total Energy
15 (None)	-	-	7.0	105	10.3	279
16 (Horizontal)	178 ± 126	288	9.8	190	11.7	552
17 (PPV)	123 ± 15	149	4.4	141	3.2	90

During Experiment 15 (no ventilation), dining room suppression decreased the heat flux to which the officer was exposed, but heat flux values increased in the period between the dining room and kitchen doorway suppression actions. The peak heat flux in this experiment was observed during fire room doorway suppression. During Experiment 16 (horizontal ventilation), the heat fluxes experienced by the officer position were high during the period of ineffective water application, but quickly decreased once water was directed into the kitchen, approximately 60 s after entry. During Experiment 17 (PPA) the peak heat flux and peak temperatures were experienced by the officer position during the kitchen doorway suppression action.

Initial suppression efforts were effective in Experiment 15, lowering the thermal exposure within the structure, while water directed into the kitchen was delayed in Experiment 16, increasing the total energy exposure compared to Experiment 15. This delay in suppression resulted in a greater amount of time that the officer in Experiment 16 spent in the upper portion of the ordinary operating class, as shown in Figure 4.30. The ceiling height of the kitchen and remote areas in Experiment 17 was 10 ft while only 8 ft in Experiment 16. The additional height of the space delayed the descent of the smoke layer, resulting in cooler temperatures and lower heat fluxes to the suppression crew, such that conditions didn't reach the higher ordinary thermal operating class during Experiment 17.

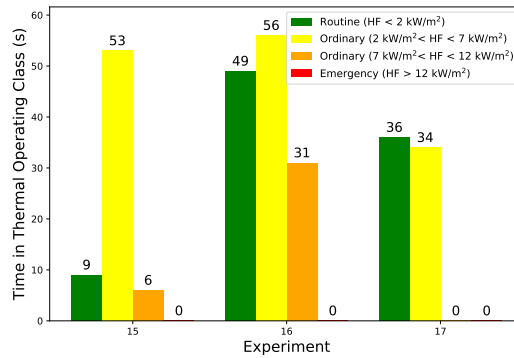

Figure 4.30: Time spent in each thermal operating class according to heat flux criteria for Method 5 Experiments where helmet data was recorded. Green indicates routine operating class ($HF < 2 \text{ kW/m}^2$). Yellow indicates lower half of ordinary operating class ($2 \text{ kW/m}^2 < HF < 7 \text{ kW/m}^2$). Orange indicates upper half of ordinary operating class ($7 \text{ kW/m}^2 < HF < 12 \text{ kW/m}^2$). Red indicates emergency operating class ($HF > 12 \text{ kW/m}^2$).

The routine operating class accounted for approximately 13%, 36%, and 51% of the total tactic time for the officer firefighter in Experiments 15, 16 and 17, respectively. During Experiment 15, the lower half of the ordinary operating class accounted for 78% of the tactic time while it was approximately 41% and 49% during Experiments 16 and 17, respectively. However, the upper half of the ordinary operating class accounted for approximately 9% of the total tactic time for Experiment 15 while Experiments 16 and 17 were 23% and 0%, respectively. Time spent in the upper ordinary operating class may have been affected by the type of ventilation, the effectiveness of suppression techniques, and the ceiling height, as the flow and move method employed during Experiment 16 was not effective in suppressing the fire until the suppression crew reached the fire room doorway threshold.

Although ventilation was conducted in Experiment 16 and 17 prior to the onset of suppression, the peak thermal exposure to the officer position was not consistent with the emergency operating class for any period of time. The largest amount of time in the upper half of the ordinary operating class was in Experiment 16, which is a product of both the extended flow-and-move and the open space between the dining room and kitchen. The lowest thermal exposure among the three experiments was observed in Experiment 17—a product of both the comparatively long hose advancement to the kitchen, during which the suppression crew was shielded, the air entrainment from the PPV fan, and the high ceilings of the first-floor. In these experiments, the close timing between ventilation and suppression reduced temperatures in the inlet portion of the flow path prior to seeing an increase in conditions remote from the fire room secondary to fire growth.

4.7 Method 6, First Floor Kitchen Fire - Ventilation Post Initial Exterior Suppression

Three experiments were conducted using Method 6, which examined ventilation occurring after exterior suppression in first-floor kitchen fires. In Experiment 18, conducted in the structure at 1030 Hilltop Road, no ventilation was provided besides the opening of the front door, in order to serve as a baseline for comparison between experiments. Experiment 19, conducted at 732 Broadway Avenue included horizontal ventilation of all first-floor windows between exterior and interior suppression actions. Experiment 20, conducted at 1492 Dayton-Xenia Road, was conducted with positive pressure ventilation following the initial exterior water application. Due to differences in building geometry including ceiling heights, interior volumes, and floor plans as well differences in event timings and weather conditions there is a limit to some of the conclusions that can be drawn across the experimental set.

In each experiment, the fire was ignited in the kitchen and allowed to grow to a post-flashover state. For all scenarios, the initial fire department intervention was exterior suppression, which varied in timing among experiments between 10:03 and 12:00 (603 s and 720 s) after ignition. The front door was opened concurrently with the end of exterior suppression, after which additional ventilation was initiated (horizontal ventilation during Experiment 19 and PPV in Experiment 20). The suppression crew's entry into the structure was delayed by 60 s after the completion of exterior suppression in order to evaluate the potential for regrowth. Structure geometry and floor plan affected the timing between each event. Table 4.30 lists the time each event occurred in the Method 5 experiments.

Table 4.30: Coordinated Method 6 Intervention Times

Intervention	Experiment		
	18	19	20
Ignition	00:00	00:00	00:00
Exterior Water Flow	12:00	11:00	10:03
Front Door Open	12:21	11:15	10:20
Horizontal Ventilation	—	11:22	—
Positive Pressure Ventilation	—	—	10:33
Suppression Crew Enters Structure	13:21	12:19	11:40
Interior Water Flow	13:28	12:33	11:55

To evaluate the effect of coordinated ventilation during suppression, two occupant tenability assessment packages were installed in each structure. One package was located in the dining room and one was located on the floor above the fire. While the dining room occupant tenability package was located in the inlet portion of the flow path established between the front door and the kitchen, the remote occupant package was remote from this flow path. The packages included instrumentation to monitor the potential for skin burns and gas concentrations. In Experiments 18 and 20, the

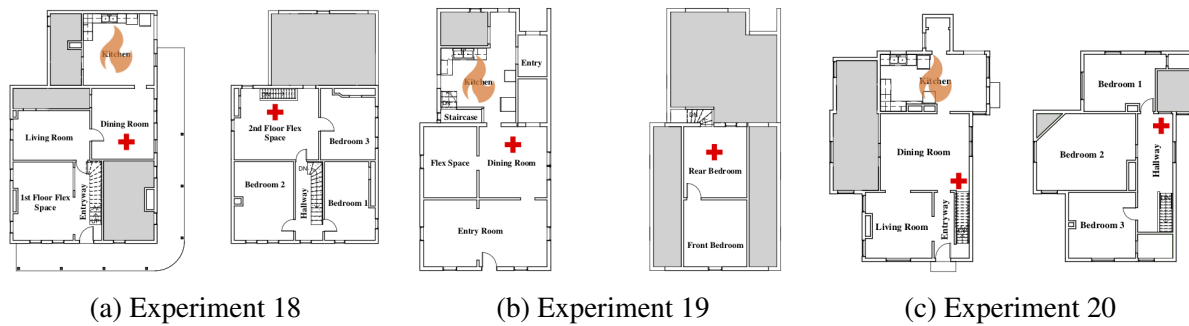

Figure 4.31: Fire floor layouts for acquired structures used in Method 6 experiments. The red crosses represent the approximate locations of the occupant assessment packages. The gray areas were isolated from the remainder of the structure and utilized as space for instrumentation.

gas concentrations at the occupant package in the dining room were monitored at two elevations, 1 ft and 3 ft above the floor, while the remote occupant package only included gas concentrations at one elevation, 1 ft above the floor. For Experiment 19, the pair of measurements were at the dining room position while the single measurement remote from the flow path. In all three experiments, skin burn assessments were at each location at the 1 ft above the floor elevation. Table 4.31 summarizes each occupant package for these three experiments within Coordination Method 6.

Table 4.31: Coordinated Method 6 Occupant Tenability Assessment Package Locations

Exp #	Location in Structure	Location with Respect to Flow Path	Distance (ft) from Fire Room
18	Flex Space	Remote	88.2
	Dining Room	Inside	12.8
19	Rear Bedroom	Remote	18.4
	Dining Room	Inside	10.7
20	Hallway	Remote	58.7
	Dining Room	Inside	9.4

The average distance from the fire room to the remote occupant package was $55 \text{ ft} \pm 35 \text{ ft}$ (mean plus/minus standard deviation). For the occupant package inside the flow path, the average distance was shorter, at $11 \text{ ft} \pm 2 \text{ ft}$. The standard deviation distance of greater than one-half of the mean values for the remote package, highlights the spatial variability between each experiment. It is therefore important to recognize that exposures are a function of the tactics studied and the relative location in each experiment. For the occupant package, the small standard deviation relative to the mean indicates spatial variations likely have a smaller impact. Figure 4.31 summarizes the fire floor layouts for each experiment in Method 6.

4.7.1 Suppression and Ventilation Tactics

In each of the Method 6 experiments, the initial fire department action was exterior water flow through the kitchen window. The suppression crew utilized a straight stream, steep angle technique, and were directed to flow until conditions visibly improved. In Experiments 18 and 19, after this initial flow, the nozzle firefighter conducted a second suppression action where they moved the nozzle past the plane of the window, changed the pattern to a wide fog, and flowed in an 'O' pattern to distribute water within the fire room. This technique was identified in previous suppression research [6] as best practice for an exterior suppression, where the initial straight stream application cools gases and the 'O' pattern wets fuel. The additional fuel wetting action was not done in Experiment 20. The exterior flow duration was 15 s, 11 s, and 14 s in Experiments 18, 19, and 20, respectively.

Prior to exterior water flow, fire room temperatures across all three experiments were approximately 1500 °F. The initial straight stream suppression reduced temperatures by approximately 200 °F to 700 °F in the fire room, as shown by the fire room temperature histories in Figure 4.32. The secondary, fuel-wetting suppression action in Experiments 18 and 19 did not have a substantial impact on temperatures in the fire room, which continued to decrease through the remainder of the experiment.

Fire room temperatures indicate that regrowth was not observed in Experiments 18 or 19, despite the additional horizontal ventilation in Experiment 19. In Experiment 20, the temperature close to the ceiling began to increase approximately 60 s after fire department intervention, although the remainder of fire room temperatures remained steady through final, interior suppression. The suppression crew was delayed 60 s from making entry into after the front door was opened in order to evaluate the potential for regrowth and to simulate any difficulty in relocating the hose line from the location of exterior water flow to the front door and the time duration between exterior water flow and interior water flow was 88, 93, and 112 s, respectively. The lack of any meaningful regrowth in the three experiments indicates the exterior suppression was effective at controlling the fire. The temperature rise close to the ceiling that was observed in Experiment 20 did not translate to an increase in temperatures elsewhere in the fire room.

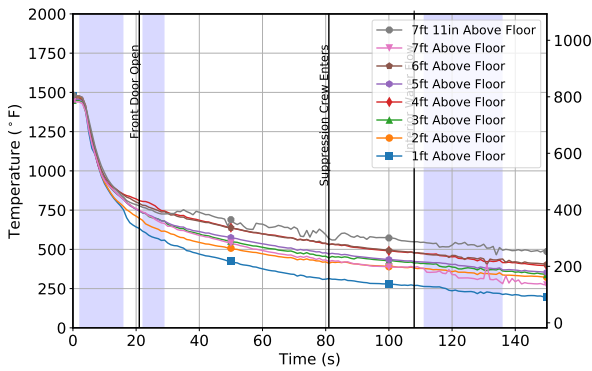

(a) Experiment 18 Fire Room Temperatures

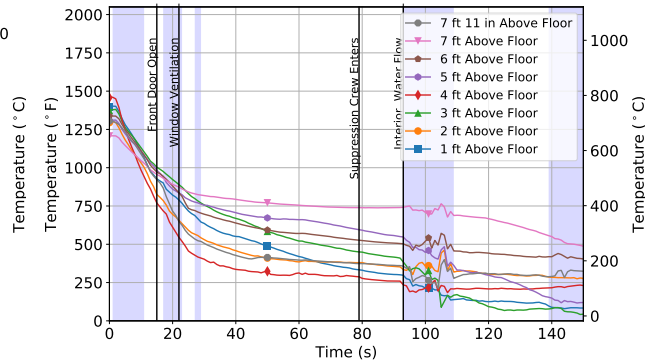

(b) Experiment 19 Fire Room Temperatures

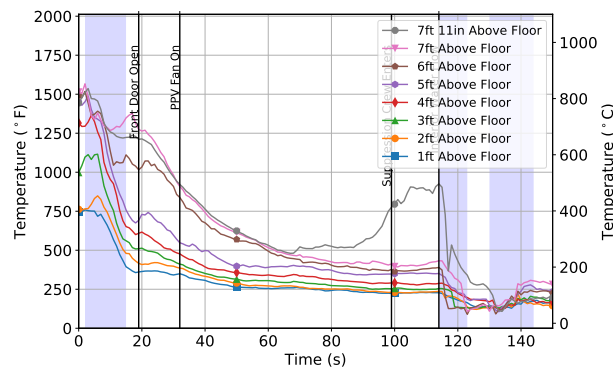

(c) Experiment 20 Fire Room Temperatures

Figure 4.32: Suppression/Ventilation effects on fire room temperatures for Method 6 experiments. Time = 0 corresponds to exterior suppression.

In each experiment, the dining room was adjacent to the kitchen on the inlet side of the flow path established after the opening of the front door (Figure 4.33). In Experiments 19 and 20, dining room temperatures were stratified prior to suppression with temperatures at the ceiling between 500 °F and 1000 °F higher than temperatures at the floor. In Experiment 18, on the other hand, dining room temperatures were approximately 750 °F from floor to ceiling. Dining room temperatures began to continuously decrease after exterior suppression in each of the three experiments. In Experiments 18 and 19, the combined suppression action of gas cooling and fuel wetting dropped temperatures at all elevations below 500 °F by the end of the suppression action, and below 250 °F within 80 s. In Experiment 20, temperatures were higher than the other two experiments at the time of intervention, but similarly decreased following exterior suppression and continued to decrease for the remainder of the experiment.

Remote temperatures within the structure further illustrate the absence of fire regrowth during the time between exterior and interior water flows. Although fire room temperatures became steady between this time, heat did not spread to remote areas along the inlet flow path. Dining room temperatures decreased after exterior suppression without fire regrowth due to additional ventilation.

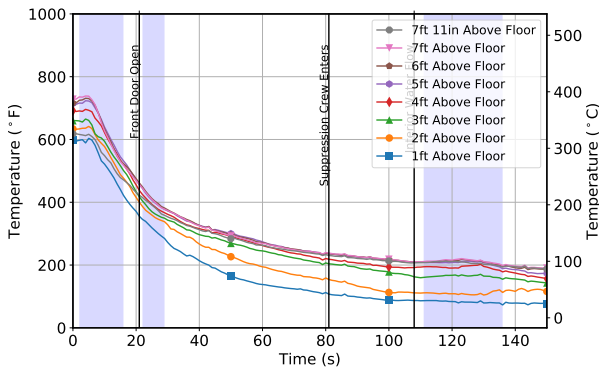

(a) Experiment 18 Dining Room Temperatures

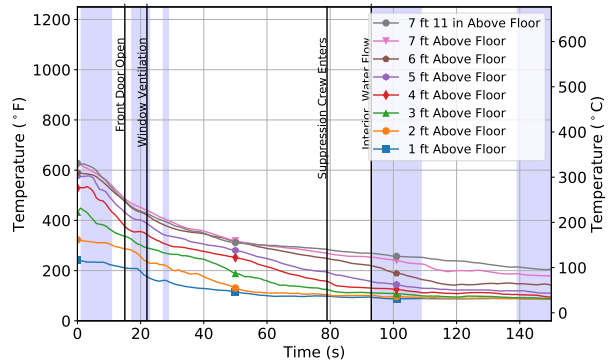

(b) Experiment 19 Dining Room Temperatures

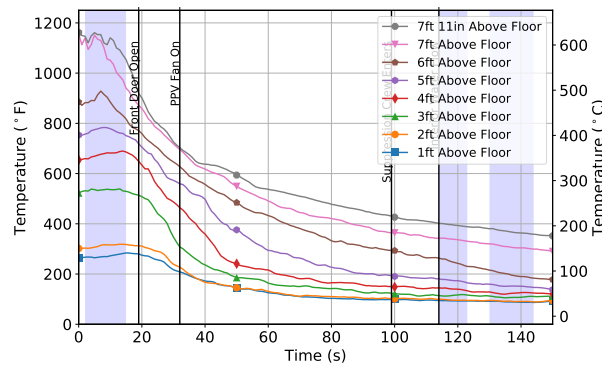

(c) Experiment 20 Dining Room Temperatures

Figure 4.33: Suppression effects on remote room temperatures for Method 6 experiments. Time = 0 corresponds to exterior suppression.

4.7.2 Occupant Tenability Estimate

Gas concentration data was captured for each of the three occupant locations for Experiments 18-20. The gas concentrations were used to compute the fractional effective dose (FED) and fractional effective rate (FER) for each experiment. The magnitude of the FEDs that were observed in the Method 6 experiments varied considerably which can be attributed to both the layout of the structure and the tactics employed. The FED values at the time of the front door opening and at the end of the experiment along with the time elapsed from the opening of the front door to the peak FER and time the CO concentrations dropped below 0.12% (1200 ppm) provide insight into how these factors impacted occupant tenability (Table 4.32).

Table 4.32: Coordinated Method 6 Occupant Tenability Estimate

Exp	Occupant Location	FED at Ext. Suppression	Final FED	Time* to Peak FER [s]	CO at Ext. Suppression [ppm]	Time* to CO < 1200 ppm [s]
18	Flex Space 1 ft	0	4.7	169	+	854
	Flex Space 3 ft	0.1	7.2	198	2900	1047
	Dining Room 1 ft	0.2	0.5	29	3100	110
19	Rear Bedroom 1 ft	119.1	716.4	25	28700	654
	Dining Room 1 ft	10.7	17.9	9	17200	96
	Dining Room 3 ft	176.6	305.5	12	30600	146
20	Hallway 1 ft	0.8	3.3	45	9300	224
	Hallway 3 ft	4.9	10.6	32	18200	191
	Dining Room 1 ft	0.4	1.2	34	6500	146

* Times are expressed as time elapsed after the initial fire department intervention (exterior suppression)
 + indicates CO concentrations below measurement error

In each experiment, conditions at the dining room occupant location started to improve after the opening of the front door, which established a flow path between the front door and the dining room. The peak FER at this location was observed within 35 s of the start of the exterior suppression action for each of the three experiments. The combination of the ventilation actions and lack of regrowth following exterior suppression resulted in a comparatively rapid improvement, with CO concentrations in the dining room decreasing below IDLH conditions between 96 and 146 s after fire department intervention, indicating ventilation and suppression were effective at improving conditions within the flow path.

Conditions in the dining room improved most rapidly in Experiment 19, where the vent crew simultaneously ventilated all of the first-floor windows at the end of the exterior suppression action. The peak FER at 1 ft and 3 ft in the dining room was observed 9 s and 12 s after fire department intervention 1 ft and 3 ft above the floor, respectively. Although CO concentrations in the dining room at the time of intervention were some of the highest concentrations observed out of any of the 20 experiments, 1.72% and 3.06% (17200 ppm and 30600 ppm), these values dropped below the threshold for IDLH conditions in 96 s and 146 s. By venting all of the first-floor windows, air could be entrained into the structure from multiple locations as opposed to from a single location, as was the case in Experiment 18.

Although the additional ventilation in Experiment 18 rapidly reduced CO concentrations on the first-floor, CO concentrations on the floor above the fire remained high for an extended period of time, due to the lack of ventilation on that level. CO concentrations on the half story in Experiment 18 remained above 0.12% for 854 s after the start of exterior suppression, compared to 96 s for the same elevation in the dining room. A similar trend was noted for the other Method 6 experiments, as shown in Figure 4.34, which compares the time from the fire department intervention until CO concentrations drop below IDLH conditions. Conditions took notably longer to improve at occupant locations on the floor above the fire than on the same floor as the fire. The smallest

discrepancy between times was in Experiment 20, indicating PPV improved conditions on the floor above even though no ventilation was provided on that floor. The values in Table 4.32 show that the total dose sustained by the occupant location on the floor above the fire increased substantially in the period after fire department intervention.

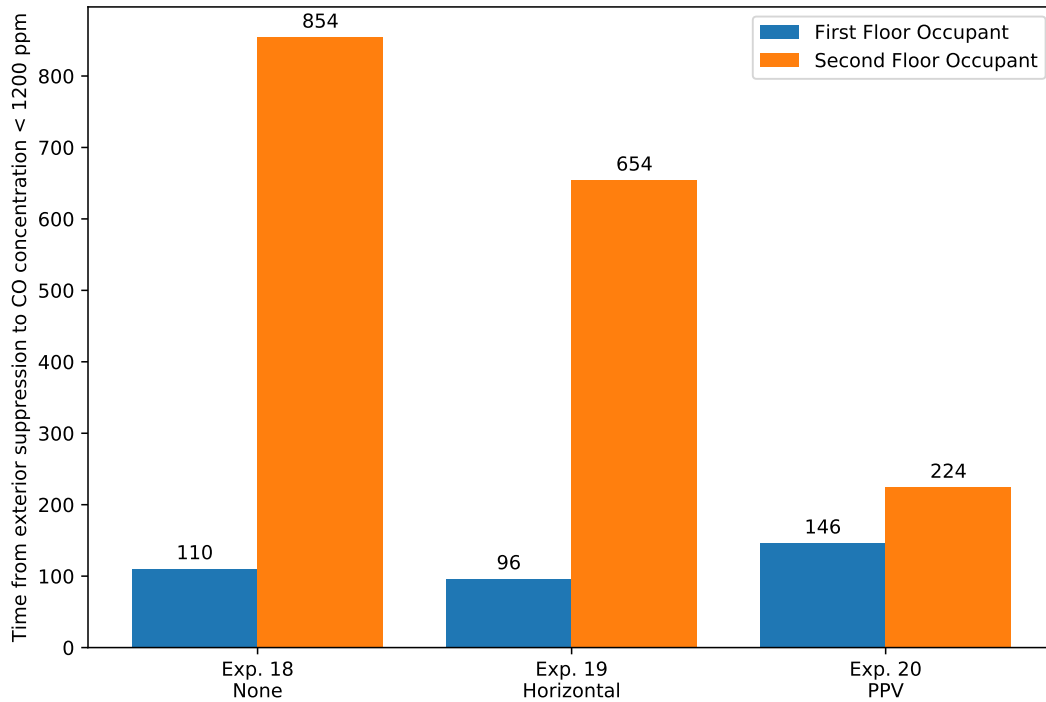

Figure 4.34: Time elapsed from the opening of the front door to the time at which the CO concentration at occupant locations dropped below 1200 ppm.

Peak surface and subdermal temperatures and time from ignition until the temperature exceeded 111 °F (44 °C), the minimum threshold for thermal injury [15], are listed in Table 4.33. In Experiments 18 and 20, the dining room occupant package, located closest to the fire room doorway, experienced the highest peak surface and subdermal temperatures. In Experiment 18, the surface temperature exceeded 111 °F (44 °C) at approximately the same time as the exterior suppression action, while the subdermal temperature did not exceed that threshold over the course of the experiment. The peak temperatures recorded for the dining room occupant in Experiment 20 were substantially higher, and exceeded 111 °F (44 °C) at both the surface and subdermal measurement locations. This suggests the possibility of deeper burn injury.

While the dining room occupant location in Experiment 19 experienced comparable peak surface and subdermal temperatures to Experiment 18, the occupant location on the floor above received a higher thermal insult. While the surface temperature at the dining room occupant location exceeded 111 °F (44 °C), both the surface and subdermal temperatures at the remote bedroom occupant

exceeded 111 °F (44 °C). The difference is a result of the interior floor plan of 732 Broadway Avenue. While, the two occupant locations were approximately the same distance to the fire room, the stairwell to the second-floor was located in the kitchen, adjacent to the window closest to the ignition location. The location of the stairwell allowed hot gases to travel directly to the second-floor before spreading throughout the fire floor. This resulted in a higher thermal and toxic insult to the occupant located above the fire than the occupant in the dining room.

For both the dining room and remote occupants, the magnitude of the peak surface and subdermal temperatures was related to the distance from the fire room. The highest peak temperatures were observed in Experiment 20, where the dining room occupant was located 9.4 ft from the fire room doorway, where the other packages were located farther away. Both the surface and subdermal temperatures at the remote bedroom occupant exceeded 111 °F (44 °C) in Experiment 19, which was located 18.4 ft from the fire room. The remote hallway occupant in Experiment 20 was located approximately 58.6 ft from the fire room and only the surface temperature exceeded 111 °F (44 °C). The most remote occupant was in Experiment 18 as the flex space occupant was located 88.2 ft from the fire room, and neither surface nor subdermal temperatures exceeded 111 °F (44 °C) at this location.

Table 4.33: Coordinated Method 6 Pig Skin Temperatures

Exp	Location	Surface Temperature		Subdermal Temperature	
		Time to 111 °F [s]	Peak [°F]	Time to 111 °F [s]	Peak [°F]
18	Flex Space	-	81	-	80
	Dining Room	712	116	-	99
19	Rear Bedroom	515	149	589	136
	Dining Room	588	123	-	108
20	Hallway	610	121	-	99
	Dining Room	435	243	666	122

- indicates value not reached during experiment

Exterior suppression reduced pig skin surface temperatures for the dining room occupant in all three experiments. As this occupant was located closest to the fire room, suppression would have a more immediate affect on this occupant. In Experiments 18 and 20, suppression also decreased surface temperatures for the occupant on the floor above. In Experiment 19, on the other hand, surface temperatures remained high, similar to the behavior of the CO concentration at this location.

The coordinated effect of exterior water flow followed by ventilation then interior water flow, reduced the thermal and toxic exposure throughout the structure without deteriorating interior conditions. Exterior water flow reduced structure temperatures and limited the potential for fire re-growth. Ventilation reduced both the toxic and thermal exposure throughout the structure. Interior water flow extinguished the fire within the structure.

4.7.3 Firefighter Helmet Thermal Exposure

Helmet mounted heat flux measurements were recorded for nozzle firefighter positions in Experiments 18 and 20 while temperature and heat flux was recorded for the officer position in Experiments 18 and 19. The results, including the peak temperatures and heat fluxes, the temperature average and standard deviation, and the total energy exposure in both the horizontal and vertical directions, are shown in Table 4.34.

Table 4.34: Thermal Exposure to Nozzle and Officer Firefighter Helmets – Method 6

Nozzle Firefighter						
Experiment	Temperature [°F]		Vertical Heat Flux [kW/m ²] [kJ/m ²]		Horizontal Heat Flux [kW/m ²] [kJ/m ²]	
	$\mu \pm \sigma$	Peak	Peak	Total Energy	Peak	Total Energy
18 (None)	-	-	3.4	114	10.5	251
20 (PPV)	-	-	1	78	8	334
Officer						
Experiment	Temperature °F		Vertical Heat Flux kW/m ² kJ/m ²		Horizontal Heat Flux kW/m ² kJ/m ²	
	$\mu \pm \sigma$	Peak	Peak	Total Energy	Peak	Total Energy
18 (None)	91 ± 70	165	1.2	24	12.6	193
19 (Horizontal)	91 ± 46	117	3.1	95	7	154

Heat flux received by the suppression crew began prior to exterior water flow, as the suppression crew positioned for the exterior water application. The heat flux received was greater in the horizontal direction rather than the vertical direction as there was no ceiling to absorb heat and re-radiate to the crew at this outdoor location. The peak heat flux in both the horizontal and vertical directions were measured during the exterior suppression action, immediately prior to the start of water flow. A second peak, lower in magnitude, was observed during interior water flow, as the suppression crew had advanced through the structure to the fire room. The lower heat fluxes observed during interior suppression indicate that exterior water flow reduced the overall thermal exposure sustained while within the structure.

Figure 4.35 provides the breakdown of the time each firefighter spent in each thermal operating class as defined by Utech. For the experiments where data was recorded, the nozzle firefighter spent approximately the same amount of time in each thermal operating class; approximately 65% to 67% routine, 30% to 31% lower ordinary, and < 1% upper ordinary. The officer firefighter during Experiment 18 spent 53% of the total tactic time in the routine class compared to 84% during Experiment 19 while time spent in the lower ordinary class was 43% and 16%, respectively. The relatively small amount of time that the officer and nozzle firefighter spent exposed to heat fluxes above 7 kW/m² reflects both the effectiveness of the initial exterior suppression and the post-suppression ventilation at reducing the thermal insult to the suppression crew.

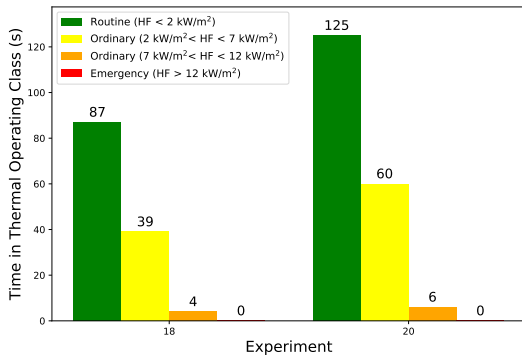

(a) Nozzle Firefighter Helmet

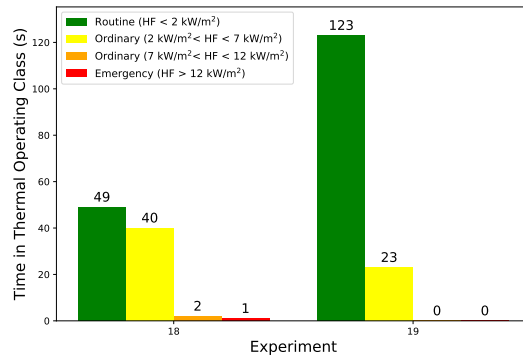

(b) Engine Officer Helmet

Figure 4.35: Time spent in each thermal operating class according to heat flux criteria for Method 6 Experiments where helmet data was recorded. Green indicates routine operating class ($HF < 2 \text{ kW/m}^2$). Yellow indicates lower half of ordinary operating class ($2 \text{ kW/m}^2 < HF < 7 \text{ kW/m}^2$). Orange indicates upper half of ordinary operating class ($7 \text{ kW/m}^2 < HF < 12 \text{ kW/m}^2$). Red indicates emergency operating class ($HF > 12 \text{ kW/m}^2$).

4.8 Summary

4.8.1 Coordination of Suppression and Ventilation Tactics

The choice of the type, timing, and location of ventilation to employ is ultimately dependent on the available resources and circumstances of the specific incident. Regardless of the type of ventilation that is employed, suppression is a key component of a coordinated attack. Fire service related research conducted over the past decade has highlighted that residential fires are more likely to be ventilation limited at the time of fire department arrival, meaning that without effective suppression, ventilation actions will eventually result in fire growth, which can be detrimental to the safety of both firefighters and potentially trapped occupants.

The experiments which sequenced ventilation before suppression showed that fire growth and temperature increase in the fire room was possible even when initial ventilation and initial suppression were separated by no more than 30-60 s. In this time, ceiling temperatures in areas located between the fire and the low-pressure vent began to increase, while temperatures at lower elevations in the same areas decreased as fresh air was entrained. It is worth noting that as suppression efforts began, ceiling temperatures in remote areas also decreased from the local cooling.

Ventilation actions which occurred after the onset of suppression did not result in additional fire growth in any of the experiments conducted as part of this series. In general, the effectiveness of post-suppression ventilation varied substantially between structures, but the experiments in which toxic gas concentrations remained highest for the longest were those in which no timely ventilation actions were performed close to the occupant location.

4.8.2 Occupant Tenability Estimate

The life safety of potentially trapped occupants is a primary concern in fire service operations. Factors which can influence the tenability of potential occupants are:

- **Proximity to Fire** — Occupants located close to the fire compartment are more likely to sustain thermal injuries. While occupants farther away from the fire room are less likely to sustain thermal injuries, they may still sustain high thermal exposures, particularly if they are located above the seat of the fire.
- **Elevation** — Products of combustion tend to fill rooms from the ceiling down, meaning that occupants located at higher elevations in the room, such as laying on a bed or couch, are exposed to higher temperatures and gas concentrations. Additionally, areas located above the fire are more likely to fill with products of combustion than areas below the fire.
- **Isolation** — Previous research [27] has highlighted the effectiveness of isolation in preserving the tenability conditions in a compartment. While closed doors can be an effective means

of isolation from both toxic and thermal insult, anecdotal evidence has suggested that methods of shielding such as household debris can serve as a means of delaying or preventing thermal injury. This is outside the scope of this project, and an area of future research.

- **Timing** — Time of exposure is a critical component of assessing toxic exposure, although one that is difficult to practically determine. Even as interventions, such as suppression and ventilation, are occurring and exposure rates (FER) are decreasing, cumulative toxic exposure will continue to increase until an occupant is removed from the fire environment. Even as conditions in the structure are improving, cumulative toxic exposure is increasing.

Figure 4.36 shows the toxic FED at the time of intervention (dark shaded) and at the end of the experiment (light shaded) at the occupant locations for each of the 20 experiments. At the time of fire department intervention, which ranged from 330 s to 781 s, the FED had not yet reached the threshold for incapacitation for 50% of the population for 77%, 74%, and 42% for the 1 ft remote, 1 ft inside flow path, and 3 ft inside flow path locations, respectively.

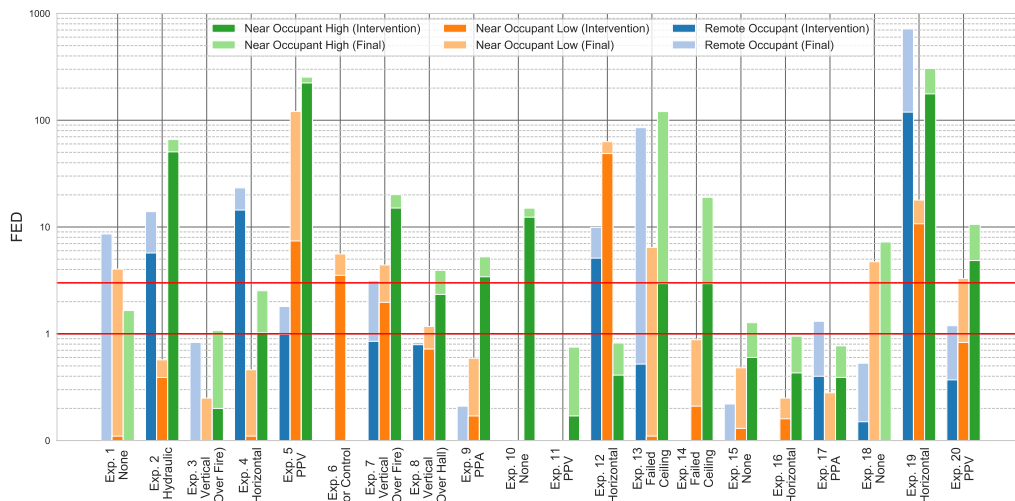

Figure 4.36: FED values at time of intervention (dark shaded) and at end of experiment (light shaded)

The FED continued to increase as suppression and ventilation actions were conducted. The magnitude of the FED increase following intervention was dependent on the magnitude of the gas concentrations in the structure and the effectiveness of ventilation tactics at reducing gas concentrations in the area of the occupant location. While suppression actions generally caused the FER to decrease, the rate at which the FER decreased varied by building construction and ventilation tactic. The experiments in which the FED increase was highest percent change from intervention to the end of the experiment were those in which no ventilation actions were conducted other than the opening of the front door (Experiments 1 and 18). By the end of the experiments, the percentage of occupants that had not reached the threshold for toxic incapacitation had dropped to 55%, 52%, and 16% for the 1 ft remote, 1 ft inside flow path, and 3 ft inside flow path locations, respectively.

The increase in FED and subsequent decrease in tenability at these locations illustrates the importance of effective suppression and ventilation tactics to minimize the toxic insult to occupants within the structure.

In general, suppression resulted in a decrease in local temperatures and gas concentrations, but there were three experiments in which suppression caused a brief increase in local temperature and gas concentrations. The two instances where this phenomenon can be most clearly seen are during the exterior suppression action in Experiment 11 (exterior suppression, PPV) and during the initial interior suppression action in Experiment 13 (exterior suppression, failed ceiling). In each of the two experiments, CO, CO₂, and temperature close to the floor increased immediately following a period of water flow.

During the straight stream, steep angle exterior water application in Experiment 11, a flow of products of combustion was observed in the thermal imaging camera in the hallway. The flow of gases followed the path indicated in Figure 4.37a. A time lapse of still images starting immediately prior to the gas movement is shown in Figure 4.37b. This movement of hot gases corresponded to an increase in FER and gas temperature at the hallway occupant location, shown in Figures 4.38a and 4.38b. The 1 ft gas temperature increased from 89 °F to 167 °F. The increase in thermal conditions resulted in a smaller increase in the pig skin surface temperature, increasing from 104 °F to 113 °F. While 1 ft CO and CO₂ concentrations, and the resultant FER, at 1 ft in the hallway remained low during the gas movement. At the 3 ft level, however, the gas movement resulted in a spike in the FER, increasing the FED from 0.2 to 0.7 over the course of the event. Approximately 25 s after the start of the event, the FER, gas temperature, and pig skin surface temperature decreased to pre-suppression values and continued to decrease for the remainder of the experiment.

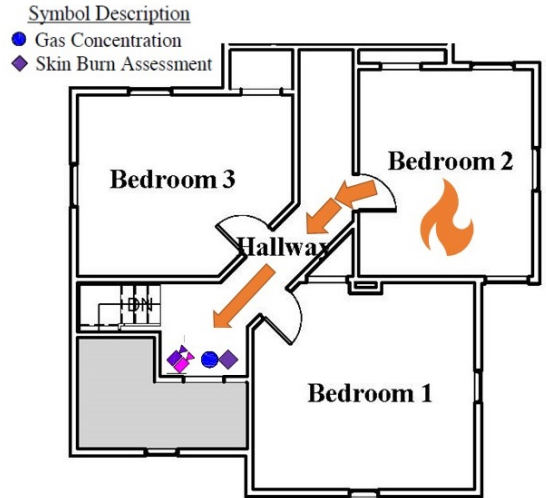

(a) Path of smoke movement in Experiment 11

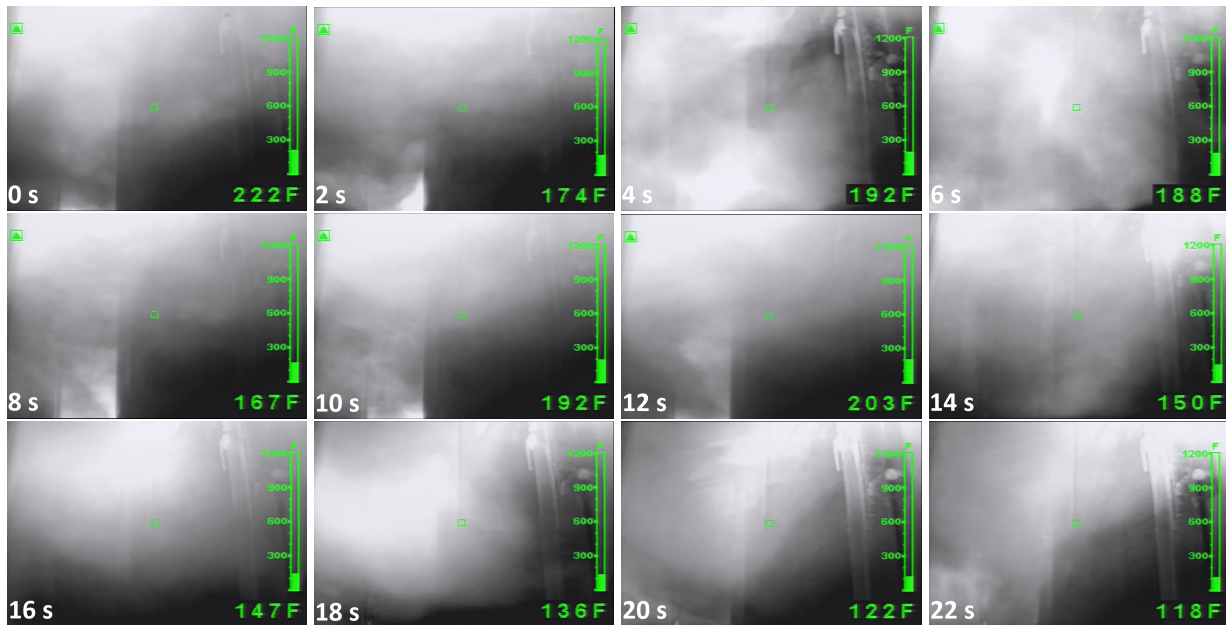

(b) Time lapse of thermal imaging camera view in Experiment 11. Still images are shown every 2 s from the start of the smoke movement.

Figure 4.37: Gas movement following suppression in Experiment 11

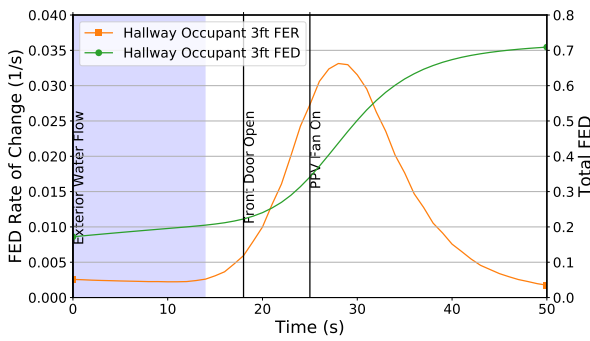

(a) Experiment 11 – Hallway 3 ft FED

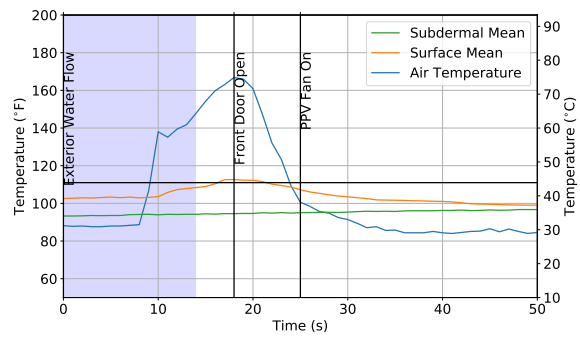

(b) Experiment 11 – Hallway 1 ft Pig Skin Temp.

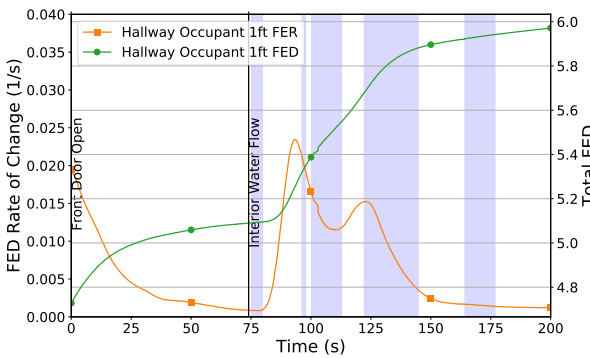

(c) Experiment 13 – Hallway 1 ft FED

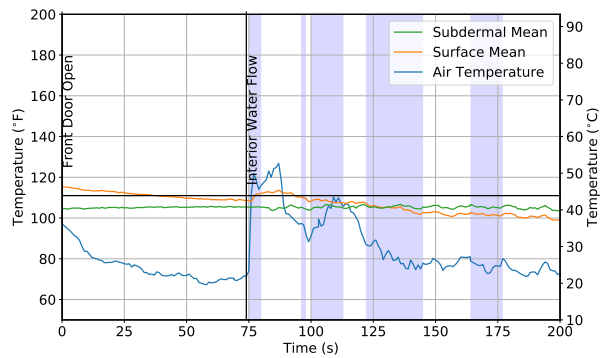

(d) Experiment 13 – Hallway 1 ft Pig Skin Temp.

Figure 4.38: Increase in FED/FER and pig skin/gas temperature following suppression actions in Experiments 11 and 13. Time = 0 corresponds to the start of exterior suppression in Experiment 11 and the opening of the front door in Experiment 13.

A similar phenomenon was observed in Experiment 13 during the initial interior suppression action. The change in conditions following the suppression action can best be seen at the 1 ft elevation in the hallway occupant package shown in Figures 4.38c and 4.38d. At the time that the front door was opened ($t = 0$) both the gas temperature and the FER at the 1 ft hallway occupant location were decreasing. Simultaneous with the initial interior suppression action, however, the FER and ambient temperature both increased, reaching a peak between 75 and 100 s after the door opening. A second increase, smaller in magnitude than the first, occurred simultaneous with the second interior suppression action 100 s after the opening of the door. The ambient temperature increased from 73 °F to 126 °F after the initial interior suppression action, and from 88 °F to 110 °F after the second interior suppression action. The pig skin surface temperature increased from 108 °F to a brief peak of 113 °F after the initial suppression action before decreasing for the remainder of the experiment. The increase in pig skin surface temperature was accompanied by an increase in FED from 5.2 to 5.4 between the first and second interior suppression actions, and an increase from 5.4 to 5.9 between the second suppression action and the end of the final decrease in FER.

In each of these cases, suppression actions resulted in an increase in gas temperature and gas concentrations close to the floor. The duration of the event was brief, lasting approximately 25 s in Experiment 11 and approximately 75 s (over the course of two distinct suppression actions) in Ex-

periment 13. In both experiments, the increase in gas temperature close to the floor increased the pig skin surface temperature, although the brief duration of the exposure and subsequent suppression efforts caused the pig skin surface temperature to quickly decrease. The toxic exposure was similarly brief, but the FED increased from 0.2 to 0.7 in Experiment 11 (250% increase) and from 5.2 to 5.9 in Experiment 13 (28% increase). While it is unclear what exactly caused the movement of gases in these two experiments, both of the structures were constructed using plaster and lathe as an interior finish. It is possible that the hose stream caused sections of the ceiling to drop, causing mixing between fresh air close to the floor and hot gases which were previously close to the ceiling.

4.8.3 Firefighter Helmet Thermal Exposure

Madrzykowski [25] emphasized that characterizing firefighters' thermal exposure in terms of peak heat flux and temperature alone fails to adequately describe the thermal threat to firefighters. Another method of estimating firefighter thermal exposure is by considering the fraction of the suppression period to which a firefighter was exposed to a given heat flux. Exposures are separated into four groups, separated by position (nozzle firefighter or officer) and suppression tactic (interior or exterior). Figure 4.39 shows histograms and cumulative distributions for data measured over the suppression period for the nozzle firefighter and officer positions for both interior and exterior suppression experiments. The vertical dashed line on each chart indicates the 90th percentile exposure.

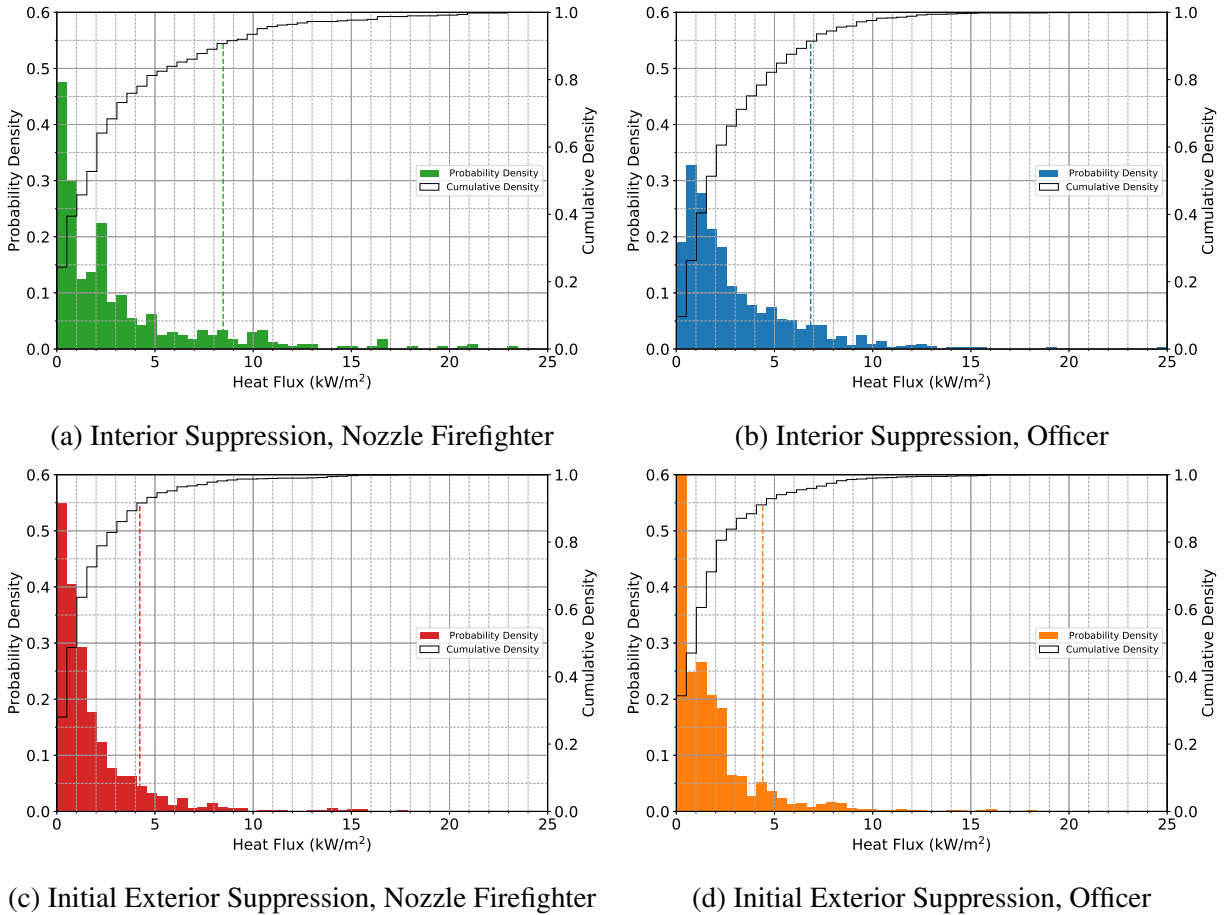

Figure 4.39: Probability density and cumulative density of heat flux exposures for firefighter, displayed by firefighter position and type of suppression. 90th percentile exposures are indicated by the dashed vertical line in each chart.

In general, both the nozzle and officer position received higher peak and 90th percentile heat flux exposures in the interior suppression experiments than in the initial exterior suppression experiments. Table 4.35 summarizes the peak and 90th percentile heat flux values recorded for each helmet/tactic combination. The peak exposures of the interior suppression experiments were 23.1 kW/m^2 and 27.0 kW/m^2 for the nozzle firefighter and officer, respectively, compared to 17.5 kW/m^2 and 18.2 kW/m^2 for the nozzle firefighter and officer, respectively, in the initial exterior suppression experiments. For each position and type of suppression, the peak heat flux was well in excess of the 12 kW/m^2 threshold for the emergency operating class [19], as well as the performance requirements of SCBA facepieces [21] summarized in Figure 4.2.

Table 4.35: Helmet Heat Flux Comparison

	Interior		Exterior	
	Nozzle FF	Officer	Nozzle FF	Officer
Peak Heat Flux (kW/m ²)	23.1	27.0	17.5	18.2
90th Percentile Heat Flux (kW/m ²)	8.5	6.8	4.2	4.4

While the peak heat flux values would indicate a severe exposure, it is important to note that duration of these peaks were brief, as demonstrated by the 90th percentile values in Table 4.35. These values reflect that for the majority of the suppression period, heat flux values were considerably lower. The nozzle firefighter and officer sustained a higher 90th percentile heat flux exposure (8.5 kW/m² and 6.8 kW/m², respectively) during interior suppression actions compared to the same positions during initial exterior suppression actions (4.2 kW/m² and 4.4 kW/m², respectively). The 90th percentile exposure for the nozzle firefighter during the interior suppression fell into the upper portion of the ordinary operating class and the others fell within the lower portion of the ordinary operating class. Figure 4.40 shows the 90th percentile values interposed on Figure 4.2 from Section 4.1, which shows that these 90th percentile values also fall within the design criteria for modern PPE.

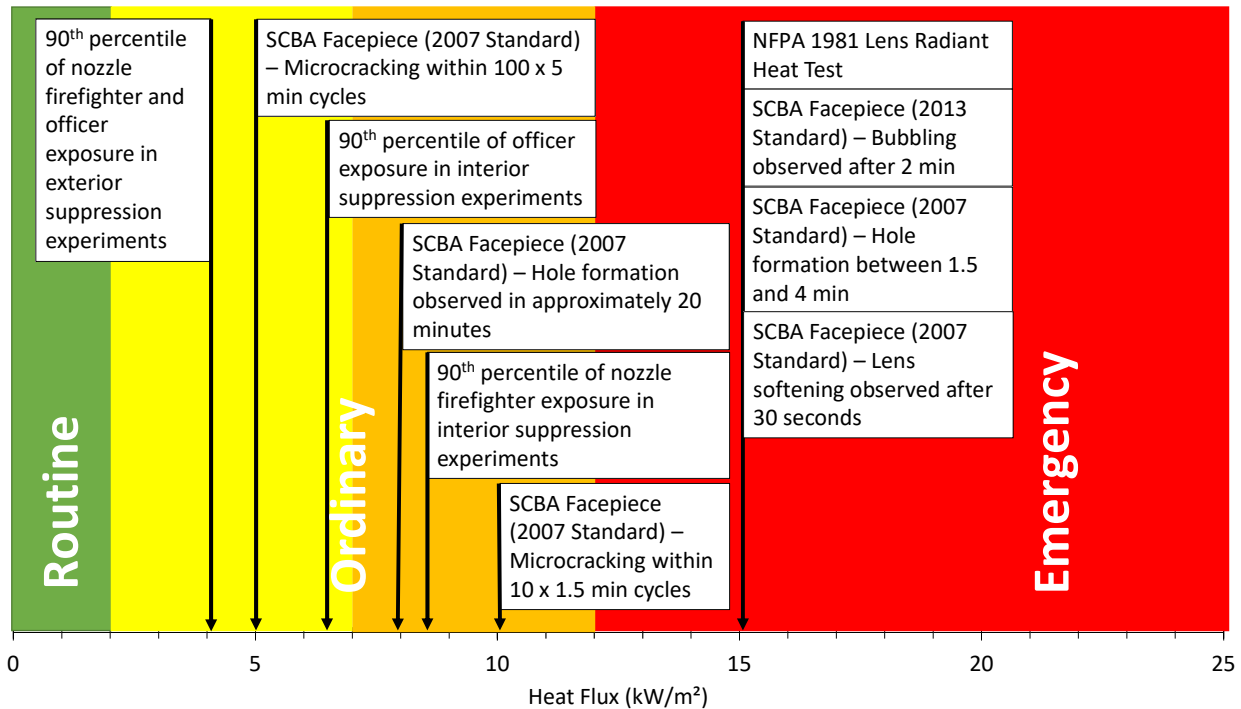

Figure 4.40: Comparison of Utech thermal operating classes with modern PPE performance limits from [21–24].

5 Tactical Considerations

5.1 Evaluation of Previous Research Findings in Acquired Structures

Previous research conducted by UL FSRI on topics including suppression, hose streams, horizontal, vertical, and positive pressure ventilation tactics were conducted in one- and two-story structures in a laboratory under controlled conditions. These structures were purpose-built to resemble floor plans of residential structures while being hardened to sustain multiple fires without losing the structure. Among the purposes of this project was to examine how tactical considerations from previous projects conducted in the laboratory compare to similar tests conducted in acquired structures. The following sections recall some of these previous tactical considerations and discuss their relevance to the current experiments.

5.1.1 Water Usage in Residential Fires

In *Impact of Fire Attack Utilizing Interior and Exterior Streams on Firefighter Safety and Occupant Survival*, which for brevity is referred to as the ‘Fire Attack’ study, experiments were conducted examining interior and exterior suppression on one- and two- bedroom fires in the laboratory [6]. The average water usage for each fire type that was examined is listed in Table 5.1. All of the experiments used less than 250 gal of water in the suppression efforts, not including the water required for final mop-up in the fire room. These experiments considered several suppression techniques—interior suppression scenarios utilized either a shut-down-and-move or a flow-and-move technique whereas initial exterior suppression scenarios utilized a straight stream pattern at a steep angle off of the fire room ceiling, followed by taking up a position in the fire room window and wetting the contents with a half-bale, ‘O’ pattern. In either scenario, the suppression method first cools gases and then wet contents.

Table 5.1: Water Usage in Fire Attack Study by Suppression Method

	Water Usage (gal)
Interior suppression, 1 fire room, no vent	83
Interior suppression, 1 fire room, 1 vent	91
Interior suppression, 2 fires rooms, 2 vents	191
Initial exterior suppression, 1 fires room, 1 vent	61
Initial exterior suppression, 2 fire rooms, 2 vent	119

The acquired structure experiments utilized a suppression package that was comparable to previ-

ous experiments, with a combination nozzle flowing 150-165 gpm. The experiments conducted as part of this project had comparable total water flows to similar experiments conducted in the laboratory. Figure 5.1 shows the water use for initial suppression (dark shaded bars) and total water usage (light shaded bars) for the 20 acquired structure experiments. Just as in the laboratory experiments, all experiments used less than 250 gal of water for fire control. Further, total water usage, including water used for overhaul and extension, was less than 500 gal. The average water usage by suppression method is listed in Table 5.2. The experiments which used the greatest amount of water for suppression were the two failed-ceiling exterior suppressions in Method 4, which is consistent with expectations, since these experiments involved two exterior water applications, followed by interior extinguishment. The experiments which used the least amount of water were those in Method 6.

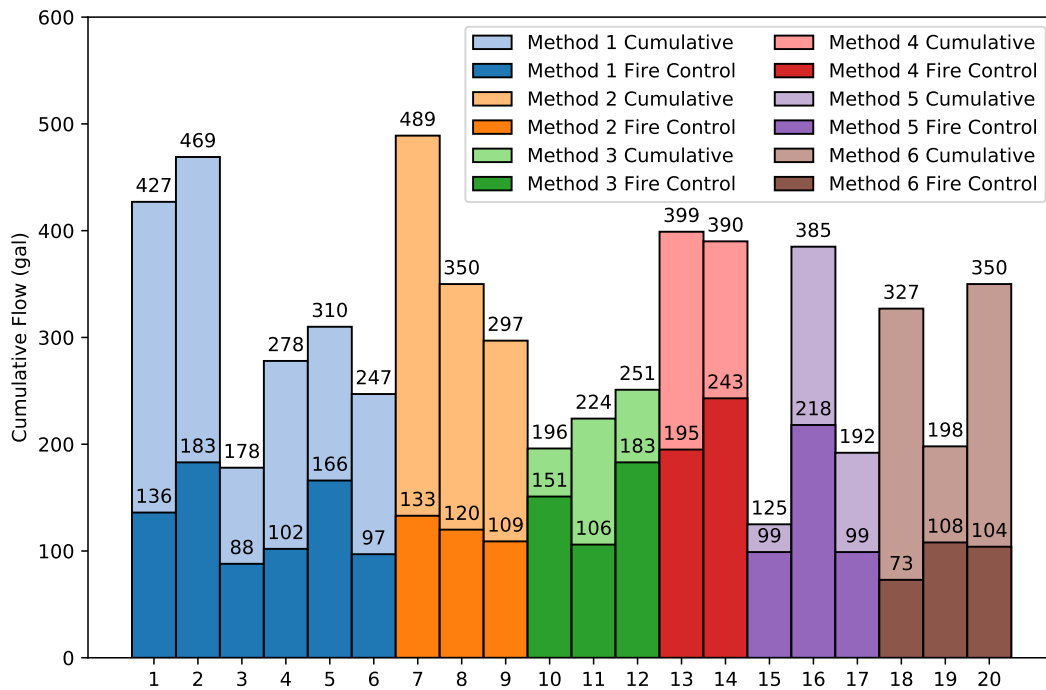

Figure 5.1: Water usage per experiment, colored by coordination method. Dark shaded bars represent water usage prior to fire control and light shaded bars represent total water usage for the experiment, including overhaul.

Table 5.2: Average Water Usage by Method

	Water Usage (gal)
Method 1 (Bedroom fire, interior suppression, ventilation after suppression)	128
Method 2 (Bedroom fire, interior suppression, ventilation prior to suppression)	120
Method 3 (Bedroom fire, initial exterior suppression, ventilation after suppression)	145
Method 4 (Bedroom fire, initial exterior suppression, missing ceiling)	218
Method 5 (Kitchen fire, interior suppression, ventilation prior to suppression)	138
Method 6 (Kitchen fire, initial exterior suppression, ventilation after suppression)	95

The water usage among the experiments in Methods 1, 2, and 3 varied from 88 gal to 181 gal, with the differences in structure layout being at least partially responsible for some of the differences in cumulative flow between experiments. Out of the twelve interior suppression experiments, Experiment 16 (kitchen fire with horizontal ventilation prior to suppression) had the highest water usage. In this experiment, the suppression crew adopted a flow-and-move technique during the advance to the kitchen fire. During suppression, there was an approximately 25 s period in which the nozzle firefighter was directing the stream at a wall outside the kitchen, resulting in a period where suppression was ineffective at reducing kitchen temperatures. This explains the reason that this experiment had a higher cumulative water flow than comparable experiments. It also illustrates how even a flow-and-move suppression technique with a substantial period of ineffective suppression used less water than the 300 gal minimum capacity for water tanks on fire apparatus [28]. Note that some of the experiments required extensive overhaul to check for extension and extinguish hot spots, which increased the total water usage for the experiment.

5.1.2 Speed of Transition and Regrowth

The Fire Attack Study examined interior and exterior suppression on first-floor bedroom fires. For these fires, the report described best practice for an exterior suppression action in two phases: surface cooling and fuel wetting. Surface cooling is achieved by directing a straight stream pattern (through a window or other opening) off the ceiling of the fire room at as steep of an angle as possible. This creates a broken stream, cooling both the room surfaces and gases within the room. After the straight stream, steep angle surface cooling suppression action, the report recommended a fuel wetting action as follows:

Once the gases have been cooled and the nozzle shut down, the nozzle firefighter should apply water to any visible flame in the compartment. If visibility is limited, a half bale (smooth bore nozzle) or narrow fog (combination nozzle) should be applied through the window in a wide ‘O’ pattern to coat the most surfaces. Care should be taken to limit air entrainment by ensuring the nozzle is placed inside the window. If the suppression crew cannot apply water directly, due to an obstruction near the opening or the elevation of the window (second-floor fire), or if tactic is ineffective, they should rapidly transition to the interior once the gases are cooled [6].”

While the action described in the second portion of the passage reduced the likelihood of regrowth following exterior suppression in the experiments conducted as part of the previous study, it also identified an important knowledge gap, as the nozzle-in-the-window application would be impractical on a similar fire occurring on the second-floor of a structure. In order to address this gap, the difference in regrowth potential between the experiments in Method 3 (second-floor bedroom fire, exterior suppression) and Method 6 (first-floor kitchen fire, exterior suppression) can be compared. In Method 3, the exterior suppression actions consisted of a 10 s straight stream application at a steep angle off the ceiling of the fire room, while in Method 6, the exterior suppression actions consisted of a 10 s straight stream application at a steep angle off the ceiling of the fire room, followed by the ‘fuel-wetting’, ‘O’ pattern in the fire room window. Following exterior suppression, the entry of the suppression crew was delayed by 60 s for both methods to simulate a delay in repositioning the line and to assess the potential for fire regrowth following exterior suppression.

The additional fuel wetting that was conducted in the first-floor kitchen experiments had a notable impact on the regrowth potential of the kitchen fires. Following exterior suppression, temperatures in the kitchen in Experiments 18, 19, and 20 decreased until the time of interior suppression, as shown in Figure 5.2, which shows the temperature profiles in the 100 seconds after the start of exterior suppression. Only in Experiment 20 did the 7 ft 11 in. temperature begin to increase prior to suppression.

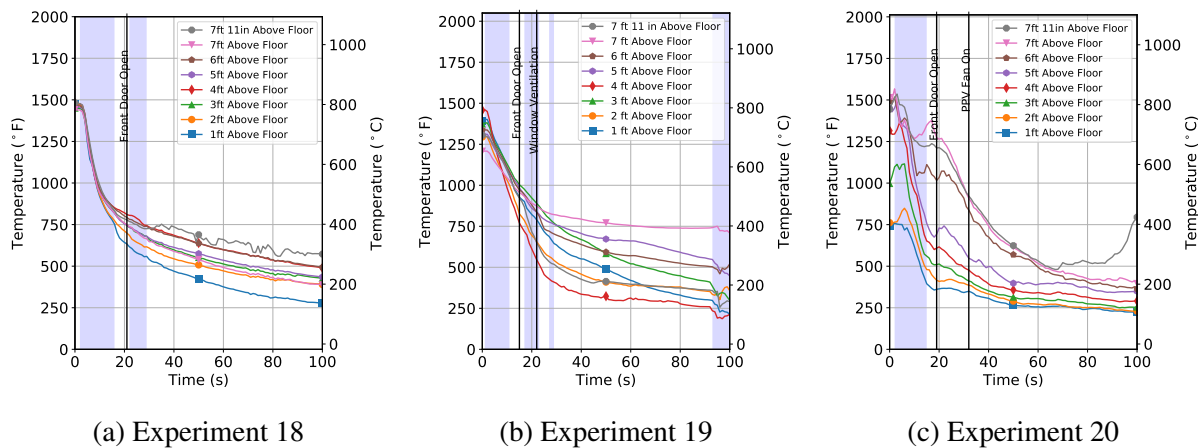

Figure 5.2: Kitchen temperature change in 100 s after exterior suppression. Time = 0 corresponds to the start of exterior suppression.

While regrowth was not seen after exterior suppression in the first-floor kitchen experiments, it was observed in each of the second-floor bedroom exterior suppression experiments in Method 3. Because of sensor errors in the fire room thermocouples, this regrowth is best demonstrated by the hallway temperatures, shown in Figure 5.3 which were measured in the hallway outside each fire room. The figure shows that temperatures close to the ceiling in the hallway begin to increase 16 s, 50 s, and 20 s in Experiment 10, 11, and 12, respectively. In Experiment 12, this regrowth was sufficient to increase temperatures in excess of 600 °F from 4 ft to the ceiling in the hallway, with the suppression crew being met with flames by the time that they reached the fire room doorway.

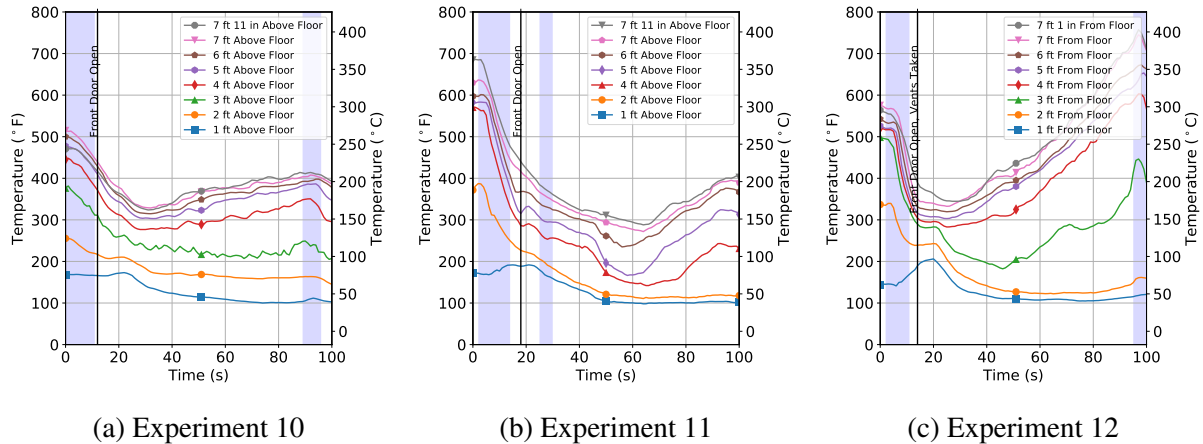

Figure 5.3: Hallway temperature change for the 100 s following start of exterior suppression. Time = 0 corresponds to the start of exterior suppression.

The suppression crew used less water, on average, during the first-floor experiments than in the second-floor experiments. The average water use in the second-floor bedroom fire experiments was 145 gal, compared to 95 gal in the first-floor bedroom fire experiments. One of the reasons that the water usage in these experiments is lower is the lack of regrowth that was observed, as opposed to in the second-floor bedroom fire experiments. Since the initial suppression was more effective at extinguishing the fire, rather than simply controlling it, less water was required to complete suppression once the suppression crew transitioned to the interior.

The potential for regrowth in scenarios where ‘fuel-wetting’ is not possible reinforces the importance of a rapid transition to the interior after the initial exterior water application. Knowing that regrowth is directly related to a continued decrease in occupant survivability, minimizing the time from completion of the exterior water application until the hose team has entered into the fire compartment for final extinguishment is key. Depending on the location of the exterior water application with relation to the point of entry for fire crews, the travel time on the exterior of the structure could be on the order of minutes if the line must be redeployed during the transition. One method to limit the travel time on the exterior of the structure would be to utilize one handline for the exterior water application, followed by a second handline deployed to the point of entry. If the location of exterior water application is directly adjacent to the point of entry for the hose team, this consideration may not be needed as the crew could rapidly transition to the interior.

If the location of exterior water application is on a different side of the structure compared to the entry point, the handline could be left in place. This would allow the crew to transition to the entry point quickly, without the burden of relocating the handline. Depending on the crew size and department response model, the second line for interior occupation could be deployed by another crew member of the initial arriving apparatus or by an incoming unit arriving after the initiation of exterior water application.

Further, if the entry into the structure is delayed for any reason, suppression crews should not let their guard down, and be prepared to flow on their approach to the fire room as they would for an

interior suppression. The regrowth of the fire may be difficult to assess prior to entry, and thermal conditions may become more severe in the time it takes to advance from the front door to the fire room doorway. In these experiments, after applying water from the exterior, the nozzle firefighter typically advanced straight to the fire room doorway, which in some cases resulted in high peak heat fluxes and temperatures prior to the start of interior suppression.

The difference in regrowth between the second-floor bedroom fire experiments and first-floor kitchen fire experiments reflects a difference in the effectiveness of the exterior suppression action in those experiments. In the first-floor exterior suppression, the combination of the gas cooling from the straight stream and the fuel wetting from the half-bale nozzle whip were effective at removing energy from the fire room and inhibiting additional fire growth. In the second-floor experiments, this additional fuel wetting was impractical, resulting in an increased potential for regrowth. This emphasizes the importance of minimizing the time between exterior suppression and interior extinguishment in cases where the initial fire control may not be as effective.

5.1.3 Effectiveness of Remote Water Application

The experiments conducted in the Fire Attack study emphasized that effective suppression requires that suppression actions, whether from the exterior or the interior of the structure, get water into the fire room. Fire streams, whether interior or exterior, cool surfaces that they can reach based on line of sight. Exterior water application typically occurs through a window, with direct access to the fire compartment, allowing for maximum surface cooling. During interior suppression, on the other hand, suppression actions remote from the fire room can be hampered by walls and similar obstructions, which can break up streams and make them less effective at suppression. Although suppression actions remote from the fire room did not always result in a decrease in fire room temperatures, they often reduced temperatures between the suppression crew and the fire room to the point where the suppression crew could continue their advance to complete suppression from the fire room.

The structures in which the experiments were conducted as part of this project had different floor plans than the structure used in the laboratory in the Fire Attack study, but a similar trend in results was observed. All of the interior suppression experiments except Experiment 6 involved at least one water application prior to reaching the fire room doorway. For the second-floor experiments, this initial suppression often occurred from the stairway, which was followed in some experiments by an intermediate suppression action from the landing before reaching the fire room doorway.

The discussion in Sections 4.2 - 4.7 described that the effectiveness of suppression outside the fire room had mixed results on decreasing fire room temperatures. Figure 5.4 shows the effect of each interior water application at reducing average floor-to-ceiling fire room temperatures for experiments where the fire room thermocouples were undamaged through the suppression period. Prior to suppression, the average fire room temperature in each experiment was in excess of 1200 °F. For seven out of the ten experiments, the suppression action which resulted in the greatest reduction in fire room temperatures was the doorway suppression action. In these seven experiments, initial suppression actions from outside the fire room had a limited impact on fire room temperatures,

which is largely because of the inability to effectively apply water into the fire room from these positions.

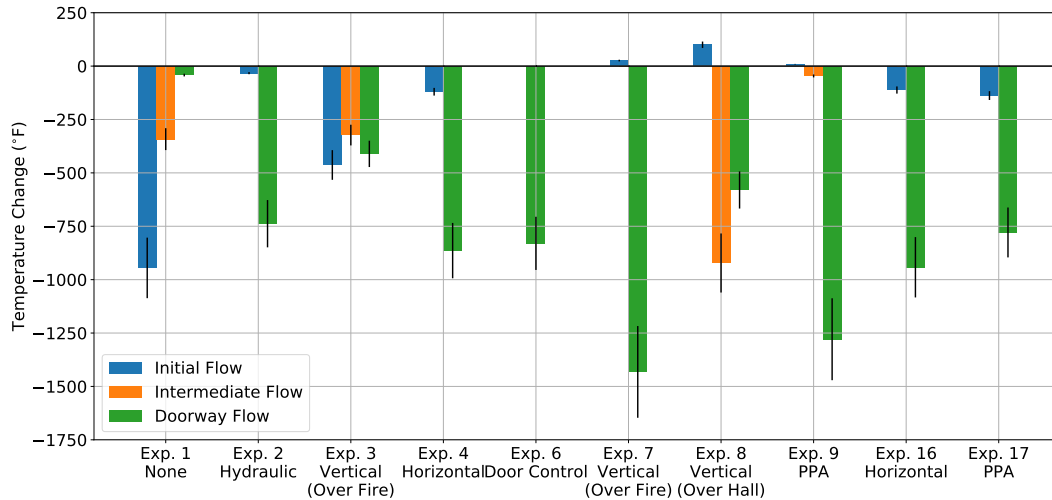

Figure 5.4: Change in average floor-to-ceiling fire room temperature as a result of suppression actions up to and including fire room doorway. Values reflect the change from the start of suppression to the end of suppression action. Positive values indicate that the average fire room temperature increased and negative values indicated the average fire room temperature decreased.

In the remaining three experiments (Experiments 1, 3, and 8), remote suppression actions were able to orient hose streams such that it was possible to apply water directly into the fire room, decreasing temperatures within it. These temperature decreases were not permanent, however, and extinguishment was not observed until the suppression crew advanced into the fire room. Consider Experiment 3 (vertical ventilation over the fire room, post-suppression) as an example. In Experiment 3, from a position on the stairway, the nozzle firefighter was able to direct their stream through the banisters directly into the fire room, as shown in Figure 5.5. The second suppression position from the top of the stairs also allowed for direct water into the fire room. Although each of these suppression actions decreased the average fire room temperatures by more than 250 °F, the temperatures in the fire room leveled off in the 35 s period between the end of the landing suppression and the fire room doorway suppression action. Immediately prior to the landing suppression action, fire could be observed in the hallway as shown in Figure 5.6. These three experiments show that remote water application can be effective, but suppression in the fire room is essential to ensure extinguishment.



Figure 5.5: Initial suppression from stairway. From a position on the stairway (shown in isometric view, left), the nozzle firefighter applied water through the banister (right), dropping fire room temperatures.

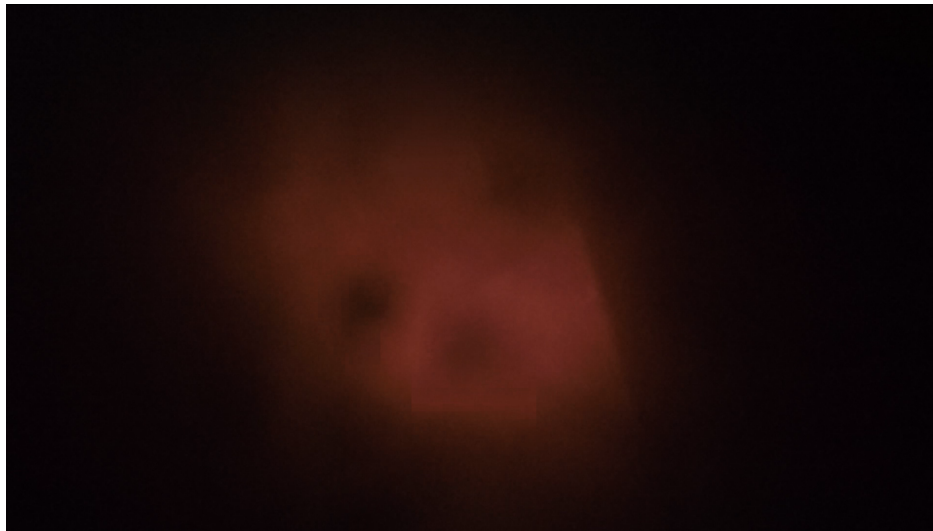

Figure 5.6: Fire in hallway after remote suppression actions in Experiment 3. While initial suppression actions from the stairway and landing reduced temperatures in both the stairway landing and the fire room, the fire continued to grow, allowing flames to extend into the hallway.

Although water application remote from the fire room did not always reduce fire room temperatures, it often substantially reduced temperatures in the path to the fire room. Figure 5.7 is similar to Figure 5.4, but shows the effect of various suppression actions on the temperatures in the room immediately outside the fire room, which was either a hallway, stairway landing, or dining room. The figure shows that the initial suppression actions often resulted in the greatest temperature reduction in the area of the suppression crew. The notable exception to this trend is in Experiment 16, where the nozzle firefighter flowed into the dining room wall for 26 s prior to flowing into the fire room. Although the flow into the dining room had a minor cooling effect in the dining room, cooling was more effective when the stream was directed into the fire room, since the two rooms were a single connected space. The resulting change in thermal imaging views is shown in Figure 5.8.

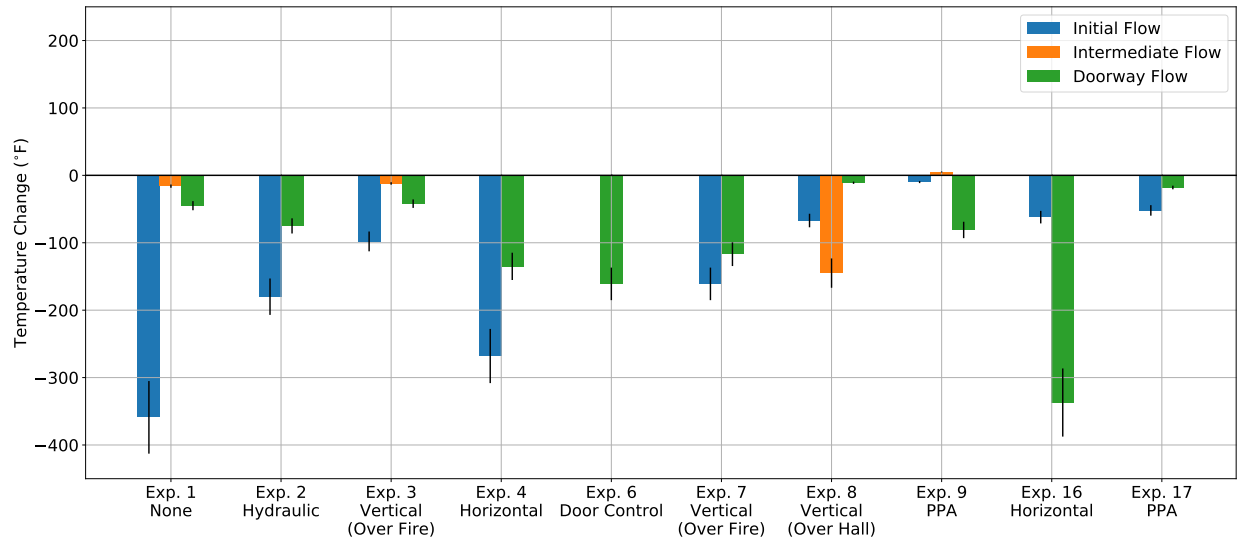

Figure 5.7: Change in average floor-to-ceiling temperature in room immediately outside the fire room as a result of suppression actions up to and including fire room doorway. Values reflect the change from the start of suppression to the end of suppression action. Positive values indicate that the average temperature increased and negative values indicated the average temperature decreased.



Figure 5.8: Thermal imaging views of ineffective water application in Experiment 16. Camera is in the dining room, directed toward the kitchen. Images show start of flow into dining room wall (left), start of flow into fire room (middle), and 40 s after start of water flow (right).

In general, the suppression crew achieved the greatest reduction in fire room temperatures once they began applying water from the fire room doorway. Depending on the layout of the structure and the presence of obstructions, remote suppression can also be effective at reducing fire room temperatures, but regrowth was possible if fire room suppression was delayed. Remote suppression actions were more effective at local cooling. Firefighters should consider using the reach of their stream to apply water into the fire room whenever possible, while realizing that complete suppression may not be ensured until reaching the fire room doorway and entering the fire room. Regardless of the possibility of directing water into the fire room, firefighters should also consider remote suppression in order to cool as they advance.

5.1.4 Placement of Vertical Ventilation Hole

Many variables inform the decision of where to place a vertical vent hole. Previous research conducted by UL FSRI in a laboratory setting examined a vertical vent hole placed over the living room in one- and two-story residential structures, and how it affected the fire dynamics of fires ignited in the living room and bedroom. With regards to coordination, the *Effectiveness of Fire Service Vertical Ventilation and Suppression Tactics* report included the following:

“Ventilating over the fire is the best choice if your fire attack is coordinated. The coordinated attack tactical consideration established that a ventilation-limited fire would increase in size if it receives air. Additionally, the closer the source of the air to the seat of the fire, the quicker it will increase in size [2].”

The results of these experiments supported that vertical ventilation occurring prior to suppression on a ventilation-limited bedroom fire resulted in fire growth. Even though only 42 seconds elapsed between the opening of the front door and water application into the fire room in Experiment 7 (vent over fire), and only 30 seconds elapsed between the completion of the vertical vent opening over the fire room and water application into the fire room, a temperature increase was noted, with a peak temperature occurring approximately 22 seconds after the opening of the front door.

It is important to note that because of the close coordination of suppression with vertical ventilation, the fire growth did not result in a measurable deterioration in conditions outside the fire room. In Experiment 7 (vent over fire) and Experiment 8 (vent over hallway), the completion of the vertical vent hole caused gas concentrations and temperatures close to the floor in remote areas of the structure to decrease. Locations closest to the inlet portion of the flow path received the most immediate positive benefit, indicating that the fresh air entrained into the stairway following the opening of the front door and completion of the vertical vent decreased the CO and CO₂ and increased the O₂ at that location. A similar trend was observed with the surface pig skin temperatures — the peak surface pig skin temperature in Experiments 7 and 8 coincided with the completion of the vertical vent, and continued to decrease as suppression actions were completed. Additionally, visibility improved in the intake portion of the flow path between the front door and the fire room.

The improvement in conditions remote from the fire room in Experiments 7 and 8 was due to the close coordination of the suppression and ventilation efforts. In each case, initial water application occurred within 30 s of the front door being opened. In the absence of suppression, the fresh air entrainment that initially improved conditions for the suppression crew and potential occupants would cause further fire growth. This would eventually cause a deterioration in conditions remote from the fire room, as demonstrated in prior experiments [2].

Effectiveness of Fire Service Vertical Ventilation and Suppression Tactics also examined the effects of making a vertical vent outside the fire room. That report conveyed the following with regards to vertical ventilation outside the fire room:

“Ventilating remote from the fire can be effective under some circumstances. If the

fire is in a room that is connected to the rest of the house by a doorway, ventilating the roof outside that room could allow smoke to clear from the rest of the house. However, while visibility may improve in the flow path leading from the air inlet to the fire room, the fire will increase in size as the air is entrained. The doorway becomes the limiting factor in keeping the fire contained [2].”

Experiment 8, which was a second-floor bedroom fire with a vertical vent opening in the hallway immediately outside the fire room doorway, illustrated an important caveat to this consideration. Because the vertical vent hole was adjacent to the doorway, fire was able to extend out of the fire room doorway and into the low-pressure vent in the hallway, as shown in Figure 5.9. Water flow in the stairway was initiated 12 seconds after the vertical vent hole was completed, therefore, the fire extension into the hallway did not result in a deterioration in conditions remote from the fire room. Thus, while vertical ventilation caused fire growth in both of the pre-suppression vertical ventilation experiments (Experiments 7 and 8), the prompt water application by the suppression crew quickly controlled and extinguished the fire. This emphasizes the importance of communication between suppression crews and crews performing vertical ventilation to avoid unwanted or unexpected fire growth.



Figure 5.9: Nozzle firefighter’s view from staircase of fire extending from fire room doorway into vertical vent hole outside the doorway in Experiment 8.

5.1.5 Survivable Space on Arrival

An important consideration at any incident is life safety, and in particular the safety of any occupant that may be trapped within the structure. In this project and in the Fire Attack study, occupant assessment packages were located throughout the structure to evaluate tenability at those locations. The results of the Fire Attack project are summarized as follows:

Two things impact the survivability of a given space in the structure: the proximity to the fire and the elevation in the space. The proximity to the fire compartment relates to the thermal exposure where the elevation in the space relates to the exposure to toxic gases and thermal exposure [6].

These experiments supported the same general trend as was observed in previous research. Occupant locations closest to the fire room typically exhibited the highest peak pig skin surface and subdermal temperatures, as demonstrated in Figure 5.10. Figure 5.10 shows the pig skin surface and subdermal temperatures for all occupant packages in the 20 experiments at the time of initial fire department intervention. The solid red line denotes 111 °F (44 °C), which is the minimum pig skin surface temperature required for thermal injury. The chart shows that the occupant packages which were closest to the fire room experienced the highest pig skin surface temperatures. In particular, many of the occupant packages which were 20 ft or closer to the fire room doorway had pig skin surface temperatures which exceeded 111 °F (44 °C), suggesting the possibility of thermal injury. A smaller proportion of the occupant packages 20 ft or closer to the fire room doorway had subdermal temperatures which exceeded 111 °F (44 °C). This suggests the possibility of deeper thermal injury. The peak pig skin surface temperature that was observed in the experiments quickly decreased as distance from the fire room increased. While skin burn assessment packages were not placed at different elevations, as was the case in the Fire Attack study, the data from this series of experiments supported the trend that occupants which were located closest to the fire room experienced the highest thermal insult, and the severity of thermal exposure was lower for occupants located farther away from the fire room.

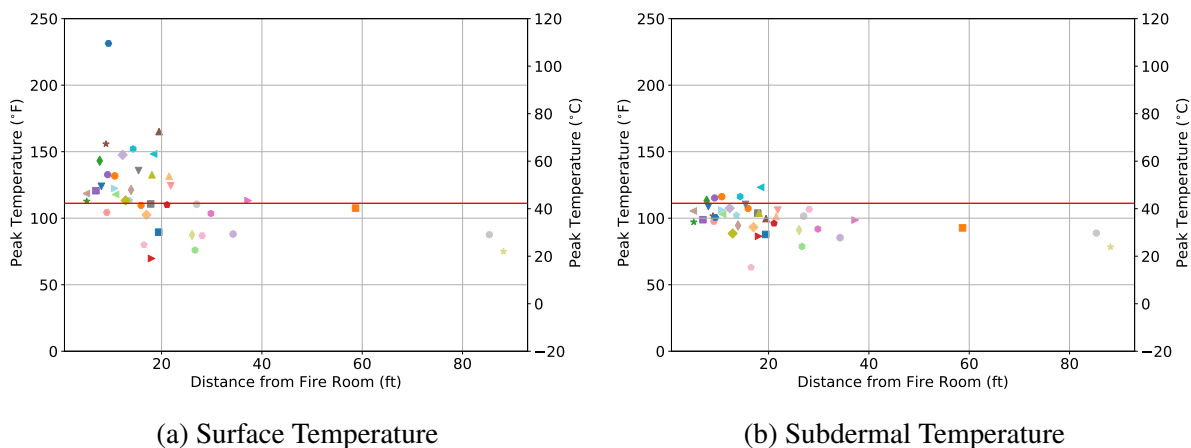

Figure 5.10: Comparison of peak pig skin surface temperature on pig skin burn assessment packages and distance of occupant package from fire room doorway at the time of initial fire department intervention (front door opening or exterior suppression). The solid red line denotes 111 °F (44 °C).

While the peak pig skin surface and subdermal temperatures at the time of initial intervention were generally related to the distance from the fire room, there was increased variability in gas concentrations and resultant FED values. This can be seen in Figure 5.11, which shows the FED at

the time of initial intervention across all experiments for each occupant package plotted against the distance from the fire room doorway to the occupant package. The figure shows that while there were occupant locations which experienced the highest toxic insults close to the fire room, there were also several occupant locations close to the fire room which did not exceed the criteria for incapacitation. Similarly, several occupant locations 20 ft or farther from the fire room doorway had sustained high FEDs by the time of fire department intervention. Figure 5.11 shows that, while occupants trapped closest to the fire may be more likely to sustain a higher dose than occupants trapped further away from the fire, there was no direct relationship between distance from the fire room and toxic exposure.

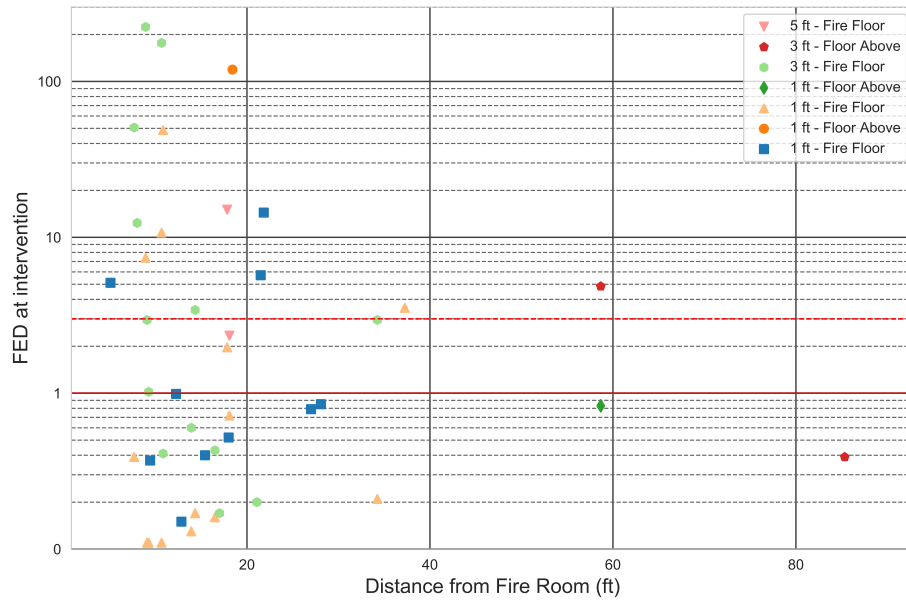

Figure 5.11: Comparison of toxic gas exposure FED at time of initial fire department intervention (front door opening or exterior suppression) and distance of occupant package from fire room doorway (top). Values are shown on a logarithmic scale to show detail at lower FED values. The solid and dashed red lines denote FED = 1.0 and FED = 3.0, which are the thresholds for incapacitation for 50% and 89% of the population, respectively.

Another way to consider the variation in toxic exposure is to group the FED value at the time of first intervention by the location of the occupant package with respect to the fire room as shown in Figure 5.12.

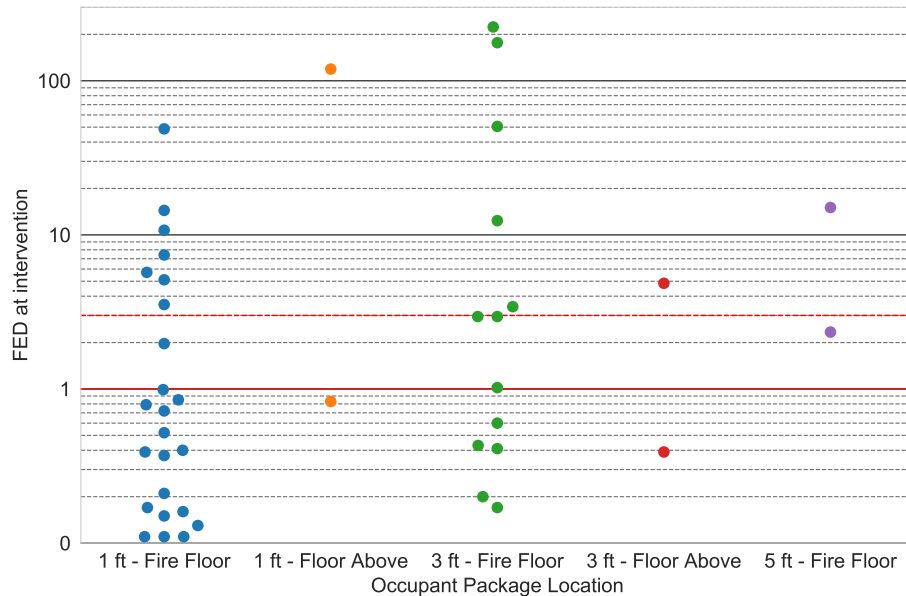

Figure 5.12: Variation of FED at time of initial fire department intervention (front door opening or exterior suppression) among occupant package locations, grouped by elevation above floor and locations with respect to the fire room. Values are shown on a logarithmic scale to show detail at lower FED values. The solid and dashed red lines denote FED = 1.0 and FED = 3.0, which are the thresholds for incapacitation for 50% and 89% of the population, respectively.

The horizontal solid and dashed red lines in Figure 5.12 represent FED = 1.0 (incapacitation for 50% of population) and FED = 3.0 (incapacitation for 89% of population), respectively. While in some experiments, the FED at the time of intervention was quite high, in many others, the FED at the time of intervention was negligible. For fire floor occupant locations 1 ft above the floor, 77% and 80% of the FED values were less than 1.0 and 3.0, respectively. Similarly, 3 ft above the floor, 67% of the FED values were less than both 1.0 and 3.0. This demonstrates that even with a post-flashover bedroom or kitchen fire, there is survivable space.

Figures 5.10, 5.11 and 5.12 show that while the highest thermal and toxic exposures were measured in the occupant packages closest to the fire room, high toxic exposures could be found even in remote locations. The discussion in Sections 4.2–4.7 emphasized that the FED at these locations continues to increase even after the onset of suppression. This reinforces the importance of effective suppression and ventilation actions to reduce the rate of toxic exposure to potentially trapped occupants. Further, the variation in the toxic FEDs at the time of intervention demonstrate how numerous factors, including structure geometry, furnishings, and environmental conditions, can cause gas concentrations to vary considerably, even among fires with similar thermal conditions.

5.2 Timeline of Coordination

Fire departments across the country are likely to have different definitions of what constitutes a coordinated fire attack. Building stock, response models, and local policies and procedures likely influence these definitions. A size-up of the critical factors is a must on every fire ground. Some of the key elements of a size-up would include building geometry, fire location and extension, construction type, existing and potential ventilation/flow paths, access, weather, and available resources. Additionally, a coordinated fire attack on an actual incident involves more moving pieces than simply suppression and ventilation, with search and rescue being an important task that is beyond the scope of this discussion. For this discussion, the definition of ‘coordinated attack’ will focus on the coordination of simultaneously occurring suppression and ventilation efforts, and the effect of these efforts on fire growth and occupant tenability.

Anecdotally, fireground ventilation may be delayed until after suppression out of concern for potential fire growth. In general, effective suppression changes a fire from a ventilation-limited state to a fuel-limited state, meaning that ventilation actions are less likely to cause fire growth leading to flashover. In twelve out of the twenty experiments (those in Methods 1, 2, and 5), the initial fire department intervention was the opening of the front door, which is both the means of access for the suppression crew and a fresh source of air for the fire. In the twelve interior suppression experiments, the average time between the opening of the front door and the first suppression action to apply water into the fire room was 29 s. The shortest time from front door open to initial water in the fire room was 18 s and the longest time was 70 s, with the difference in these values largely depending on structure geometry, although it should be noted that firefighters walked through the structure prior to each scenario and these values may represent best case scenarios with regards to familiarity with interior layout.

Despite the short amount of time elapsed between initial ventilation actions and suppression in the fire room, temperature and pressure increase were measured in the fire room in several of the experiments, including those in which the only ventilation provided prior to suppression was the front door. The efficient flow path created by the opening of the front door resulted in an increase in fire room temperatures, although this fire growth did not always translate to an increase in thermal conditions outside the fire room.

Figure 5.13 shows the change in average temperature from the time the front door was opened to the second before initial water flow at each elevation in areas of the fire floor outside the fire room for experiments with ventilation occurring prior to suppression. The charts show that for Experiments 7 (vertical vent over fire room), 9 (PPA), and 17 (PPA), temperatures did not increase by more than a few degrees, and generally decreased in the period following the opening of the front door, particularly close to the floor. This is at least in part due to the entrained air from the open front door and other ventilation actions in the period between ventilation and suppression. In Experiment 8 (vertical vent over hall), temperatures increased at elevations close to the ceiling as a result of fire venting into the hallway after completion of the low-pressure roof vent. Although temperatures close to the ceiling increased, which may increase radiative heat transfer to advancing firefighters, temperatures 5 ft and below decreased due to entrained air, potentially providing

cooling for the suppression crew. In Experiment 16, the temperature increases close to the ceiling were a result of a lack of compartmentation between the kitchen, bedroom, and dining room. Temperatures close to the floor again decreased from the entrained air.

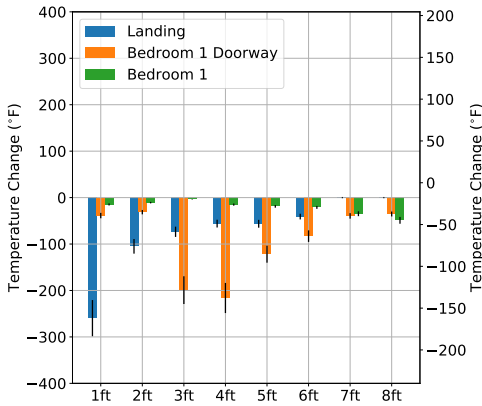

(a) Experiment 7

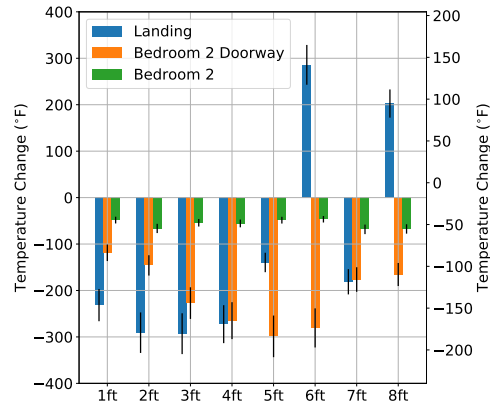

(b) Experiment 8

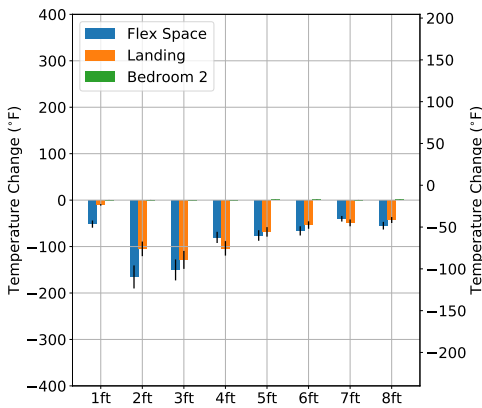

(c) Experiment 9

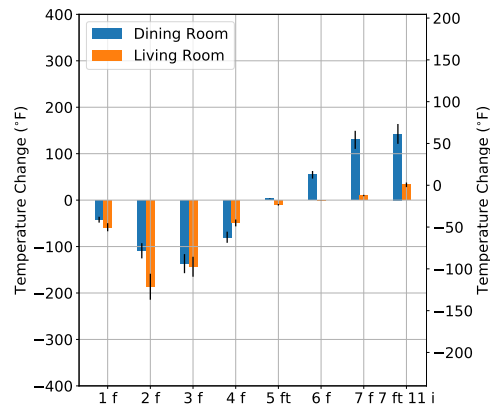

(d) Experiment 16

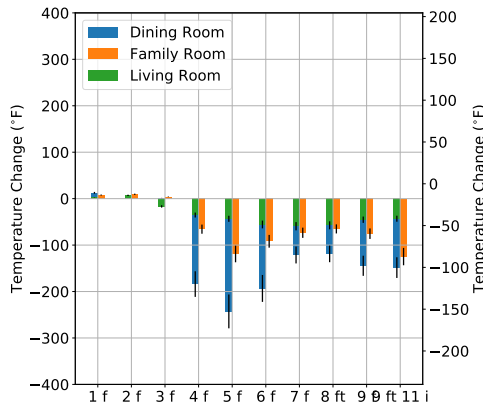

(e) Experiment 17

Figure 5.13: Change in average compartment temperature outside of the fire room from initial ventilation to suppression for experiments where ventilation actions were taken prior to initial suppression. Bars indicate the temperature change from the time the front door was opened until the initial water flow into the fire room for each elevation in areas of structure remote from the fire room. Negative values indicate that the temperature at location has decreased, while positive values indicate that the temperature has increased.

The experiments which sequenced ventilation before suppression showed that fire growth and temperature increase in the fire room was possible even when initial ventilation and initial suppression were separated by no more than 30-60 s. In this time, ceiling temperatures in areas located between the fire and the low-pressure vent began to increase, while temperatures at lower elevations in the same areas decreased as fresh air was entrained. It is worth noting that as suppression efforts began, ceiling temperatures in remote areas also decreased from the local cooling.

Ventilation actions which occurred after the onset of suppression did not result in additional fire growth in any of the experiments conducted as part of this series. For this reason, suppression crews might consider a “water on the fire” transmission as suppression actions are being taken, whether on the interior or exterior, which would provide information to other crews operating on the fireground about when to begin ventilation. In general, the effectiveness of post-suppression ventilation varied substantially between structures, but the experiments in which toxic gas concentrations remained highest for the longest were those in which no timely ventilation actions were performed close to the occupant location. This is particularly evident in Experiments 18, 19, and 20, where occupant packages were located on the second story of the structure, above a kitchen fire on the first story. The ventilation actions in these experiments were not performed on the level at which the occupants were located. Figure 5.14 shows how these CO concentrations at these second-floor occupant locations remained high for significantly longer than their first-floor counterparts. Occupants at these locations would continue to sustain a higher toxic exposure for an extended period of time, even though suppression efforts were reducing temperatures and gas concentrations elsewhere in the structure. For this reason, it is important that coordinated ventilation includes ventilation actions throughout the structure, in an effort to improve conditions close to these remote occupants.

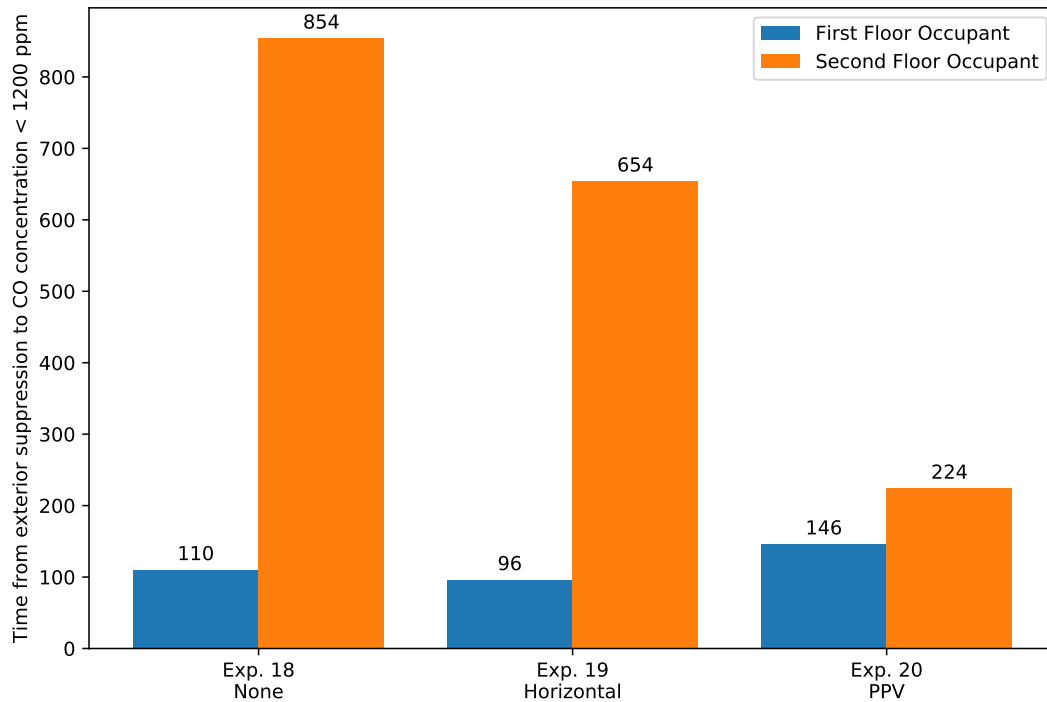

Figure 5.14: CO recovery times for experiments where lack of ventilation resulted in long recovery times.

Fire service research conducted over the past twenty years has demonstrated that fires in residential homes filled with modern furnishings have a propensity to reach ventilation limited conditions more quickly. Because of this, ventilation actions occurring prior to suppression have the potential to result in rapid fire growth, which can create dangerous conditions for firefighters and building occupants without the benefit of a hoseline. Ventilation decisions should consider this possibility, while also keeping in mind that prompt ventilation may result in the best outcomes for potentially trapped occupants. In this series of experiments, ventilation actions which occurred immediately before or immediately after the onset of suppression actions had an overall greater benefit than when no additional ventilation actions were conducted at all.

5.3 Maximize the Effectiveness of Water Application by Considering Alternative Means of Water Distribution

Previous research into water application [6] highlighted the importance of coating as many surfaces as possible, either from the interior or the exterior to achieve full knock down of the fire. The experiments conducted as a part of the Fire Attack study focused on water application techniques

to cool gases followed by cooling burning surfaces of the fuels. For exterior water application, this was achieved by initially knocking back the fire via a straight stream, steep angle approach from a fixed position. The straight stream, steep angle creates a broken stream after contacting the ceiling which distributes water droplets across the ceiling and over the walls of the fire compartment providing rapid cooling and contraction of the fire gases. Several of the experiments then incorporated a second exterior water application via a half-bale (smooth bore nozzle) or 30 degree fog (combination nozzle) directed into the window and rotated in an ‘O’ pattern to wet as many burning surfaces as possible. This second exterior water application was conducted as a result of the findings from the Fire Attack study Water Mapping report [4], which showed that a limited amount water reaching the center of the compartment with only a straight stream, steep angle approach. On the interior of the structure, the same approach was taken with cooling gases followed by burning surfaces. As the nozzle firefighter reached the doorway to the fire compartment, the stream was directed at the ceiling to cool the gases rapidly, much like the exterior application, followed by the lowering of the stream onto the burning fuel surfaces.

In discussions with technical panel members from the current project, as well as those from the Fire Attack project, concerns regarding exterior water application centered around several “what if” scenarios including the likelihood that a post-flashover compartment fire could have weakened or missing sections of the ceiling. Most construction of single family homes in the United States utilizes gypsum board as a lining material. Some older constructed homes were built with plaster and lath, as seen in the acquired structures used in this set of experiments. With fires in compartments lined with gypsum or plaster and lath, the concern for weakened or failing surfaces grows higher as the fire burns longer. A weakened ceiling surface could allow the hose stream to punch through allowing water to enter a joist-bay above or possibly into the attic space if the compartment fire is on the top floor of the building. Additionally, portions of the ceiling surface could degrade to the point of failure and fall into the compartment independent of fire department action. Both of these situations would provide a challenge for successful exterior water application. If the fire compartment were located on the ground level and obstructions were minimal, the nozzle firefighter could approach the window as in the Fire Attack study for additional water application to coat burning surfaces. If the fire compartment were located above the ground level and still within the reach of the hose stream, additional distribution could be achieved through a lintel hit. This involves deflecting the hose stream off of the top of the window frame. As shown in the study of Water Mapping within Compartments, deflecting the hose stream off of the lintel allows the stream to break up into droplets and provide better water distribution onto burning surfaces in a typical residential sized compartment.

The two experiments in Method 4 (Experiments 13 and 14) were designed to examine straight stream exterior suppression in a compartment with a ceiling failure. The fire room temperature data, shown in Figure 5.15, indicates that although temperatures in the fire room decreased following the straight stream suppression, they began to increase again approximately 40 s after the end of suppression. In each case, the lintel hit was more effective than the straight stream at reducing fire room temperatures, although experiments were not conducted with the lintel hit as the first exterior water flow.

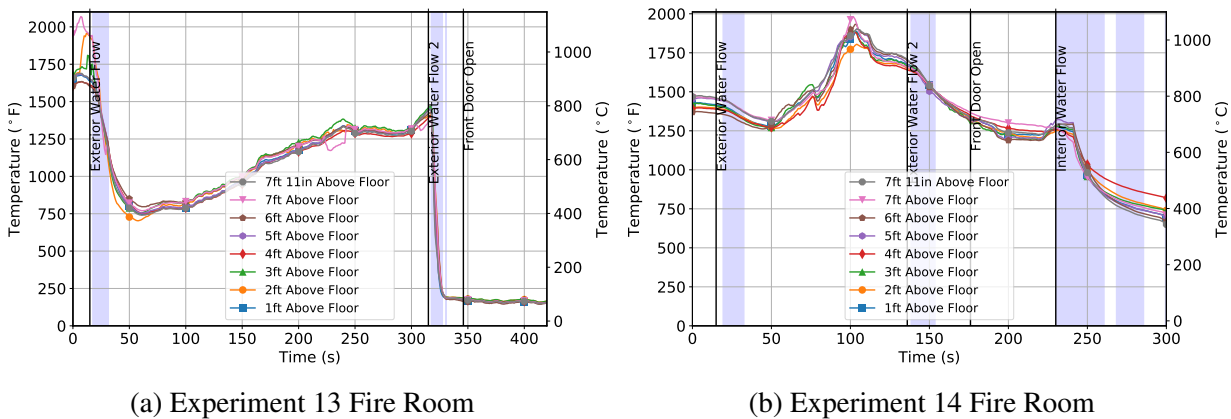

Figure 5.15: Effect of suppression actions on fire room temperatures in Method 4 experiments. Time = 0 corresponds to the beginning of the straight stream suppression action and data is included for 300 s after fire department intervention.

A slight difference between experiments that impacted the effectiveness of the straight stream suppression was the presence of ceiling rafters. In Experiment 13, the ceiling rafters were left intact, whereas in Experiment 14, they were removed. These rafters ran perpendicular to the direction of the hose stream, and were difficult to identify from the ground due to the fire venting from the window at the time of initial suppression. Their impact on the hose stream is illustrated in Figures 5.16a and 5.16b—the rafters provide an additional obstacle to break apart the hose stream, deflecting water onto burning surfaces and providing more cooling, as shown by the difference in temperature recovery between the two experiments in Figures 5.15a and 5.15b. In Experiment 13, fire room temperatures take several minutes to recover after the initial decrease due to suppression, while in Experiment 14, the fire room recovers to post-flashover temperatures within 50 s.

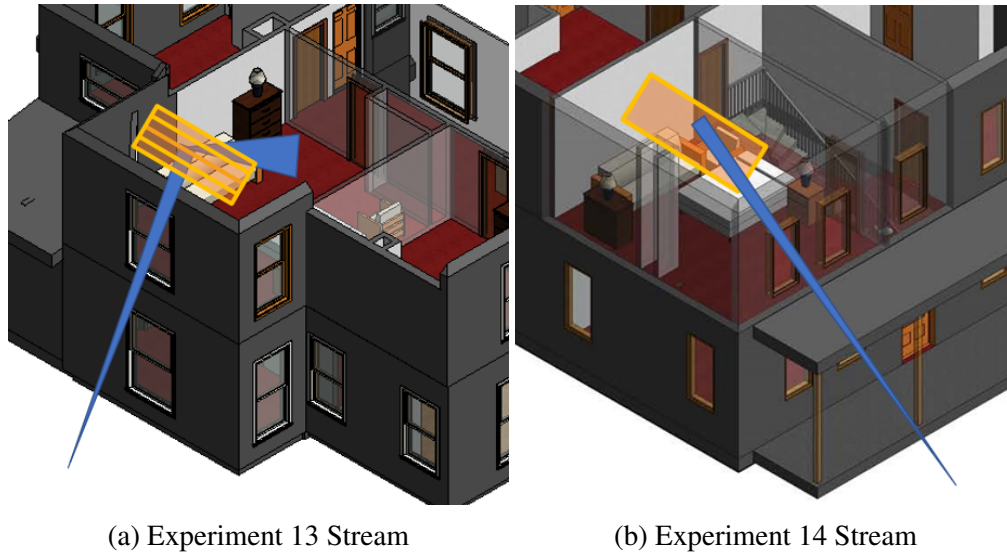

Figure 5.16: Comparison of initial straight stream, steep angle exterior water application and resulting distribution. In Experiment 13, the stream hit the rafters, breaking the stream apart while in Experiment 14, the rafters were removed, allowing the stream to pass through the missing ceiling unbroken.

Consideration should be given to including the lintel hit into the approach for exterior water application. Studies conducted both in a controlled laboratory setting and in acquired structure experiments highlight the importance of both gas cooling and surface cooling during water application. Gas cooling is achieved through the straight stream, steep angle approach. Conditions in the fire compartment should change for the better and provide a visual representation of improvement to the nozzle operator outside. If a straight stream, steep angle is applied from the exterior into the fire compartment and a change in conditions is not noted within a relatively short time frame, the stream may have punched through the ceiling lining or the lining material may have failed. A lintel (or window header) hit will likely improve water distribution inside the fire compartment as shown in Figure 5.17.

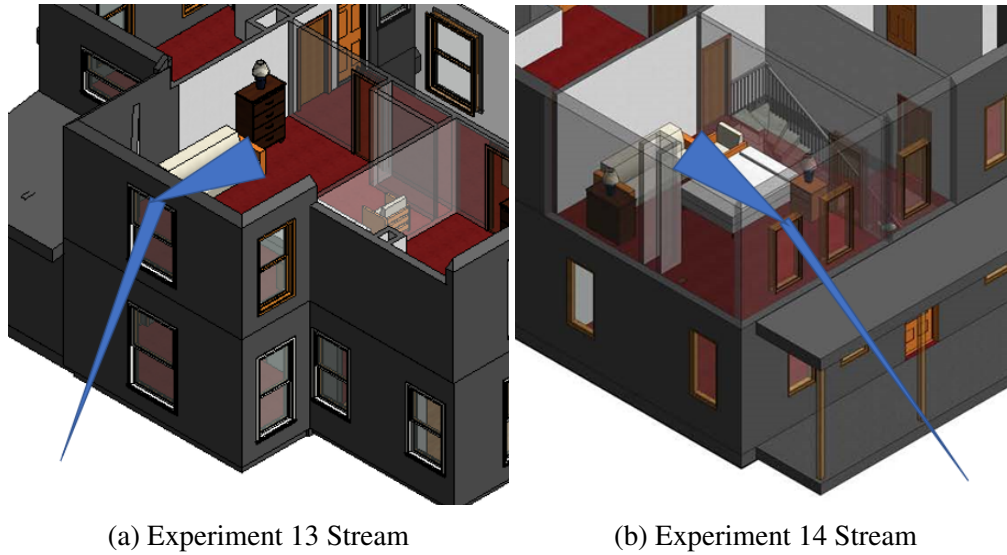

Figure 5.17: Lintel (or window header) hit water application from the exterior and resulting distribution.

It should also be noted that even if the traditional straight stream, steep angle approach appears to have knocked down the fire, regrowth is an important concern until the nozzle team has made it to the fire compartment from the interior for complete fire extinguishment. To minimize regrowth potential, the lintel hit may be considered as an integral component to exterior water application regardless of the perceived effectiveness of the straight stream, steep angle approach.

In a related manner, the importance of cooling during the advance of the hose team on the interior of a structure was highlighted in the Fire Attack study [6]. Knowing the potential hazards of a hose team advancing down the hallway toward a fire compartment, it is critical to flow water early. The current study reinforces that hose stream dispersion follows line of sight principles. With this in mind, a hose team is able to get water into a fire compartment much earlier than arriving at the threshold of the door using similar principles to the lintel hit. See Figure 5.18 below.

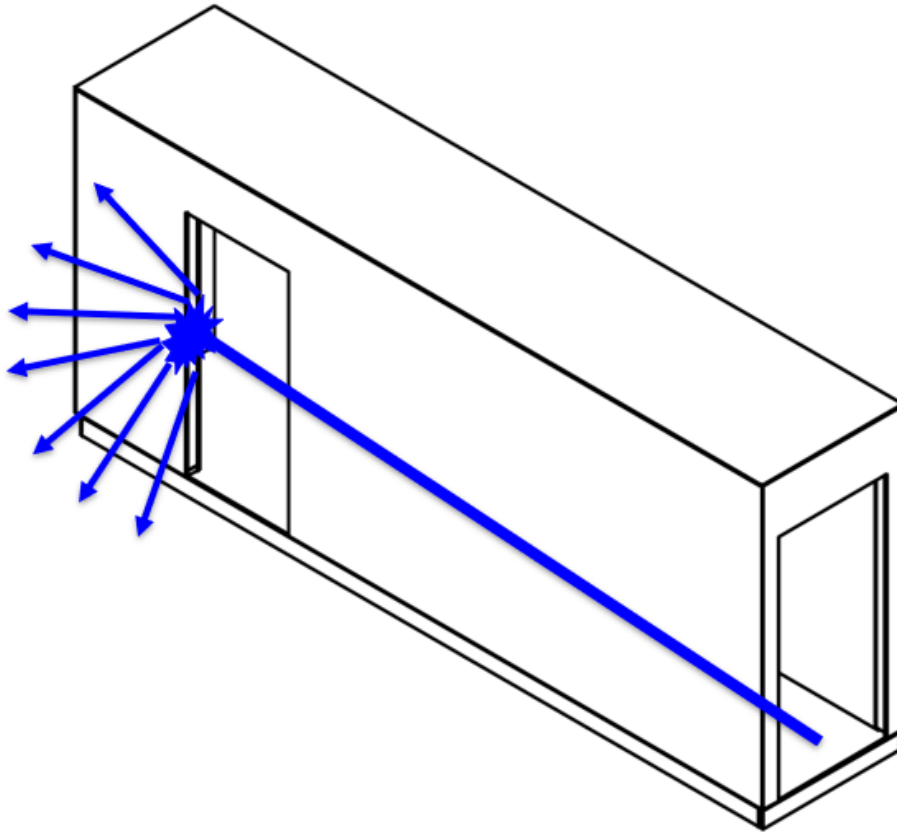

Figure 5.18: Interior dispersion with water application to the king stud (or door frame) of the fire compartment doorway.

As a hose team advances toward the fire compartment flowing water, they can use audible clues of a change in sound for water deflection in combination with any visual to determine the doorway to the fire room. (See Figure 5.19)



Figure 5.19: Interior view along the entry path looking toward the fire compartment (a kitchen). Note: The doorway king stud highlighted in red.

If the nozzle operator is able to determine the location of the door frame, water can be deflected into the fire compartment by manipulating the nozzle up and down along the frame. This will cause the stream to break apart, sending some component of the water into the fire compartment and cooling surfaces long before the hose team has even reached the room for entry.

5.4 Local Ventilation and Remote Occupants

In all 20 experiments, the fire department intervention of opening the front door created an additional flow path from the front door to the fire room doorway, and involved the entrainment of air along the path between the two. For the experiments where an occupant exposure package was located between the front door and the fire room doorway, the entrained air from the exterior doorway resulted in a reduction in CO and CO₂ concentrations and an increase in O₂ concentrations. Across all such experiments where there was an occupant package located in the flow path between the front door and the fire room, the 1 ft FER began to decrease an average of 22 s after the opening of the front door, with a standard deviation of 28 s. The longest time from the opening of the front door until the peak FER was in Experiment 13, where an increase in gas concentrations and temperatures close to the ground was observed at the same time as the initial interior water flow.

While occupant locations in the flow path experienced a benefit after the open front door, occupants which were remote from the flow path took longer to experience a benefit from suppression and ventilation actions. Figure 5.20 provides a comparison between the time from the opening of the front door until the FER started to decrease for all experiments which had occupant locations 1 ft above the floor that were both in and out of the flow path. For occupants that are outside the flow path but in an area open to the room of fire origin, conditions do not start to get better until later

in the experiment. Consider Experiment 3, which was a second-floor bedroom fire with vertical ventilation occurring approximately one minute after the start of suppression. Although the FER in the hallway started to decrease as the suppression crew was applying water to the fire room, conditions in the remote bedroom occupant package did not begin to improve until more than 2 minutes later.

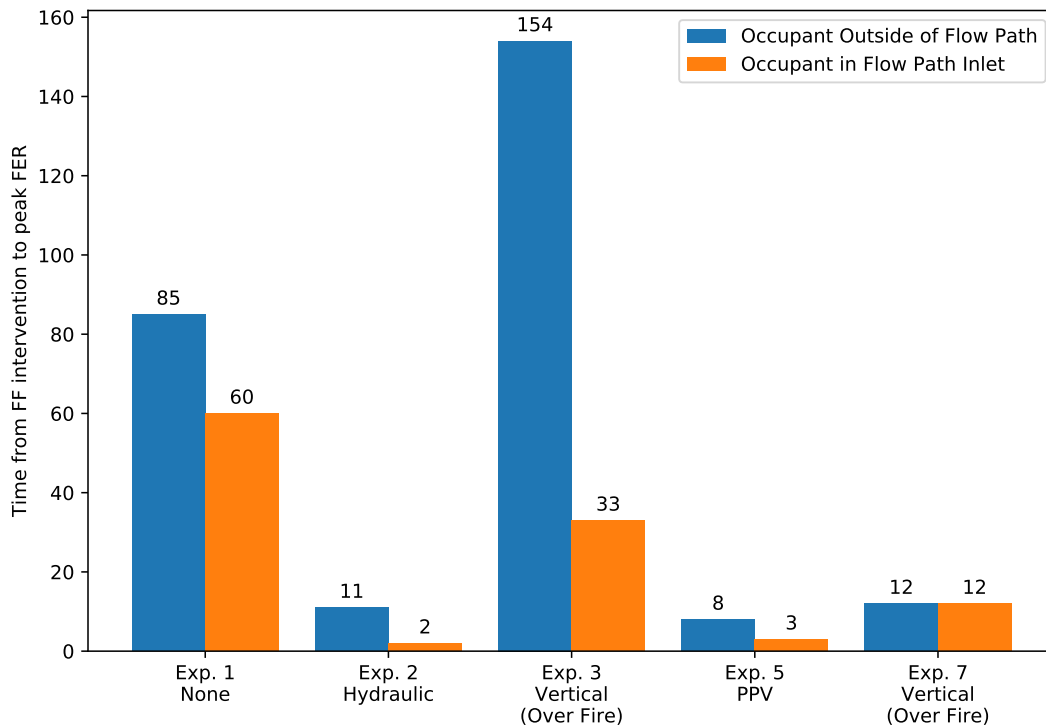

Figure 5.20: Comparison of time elapsed from opening of front door to peak FER for occupants located in the inlet portion of the flow path vs. occupants remote from flow path. Experiments where one of the sensor locations experienced a sensor error are not included.

This longer time to improved conditions can have important implications for remote occupants. Figure 5.21 shows the increase in FED from the time of front door ventilation to the end of the experiment for remote occupants (y-axis) plotted against occupant locations in the inlet flow path (x-axis). The black line running through the center of the plot is a line of equivalence, meaning that experiments falling above the line experienced a higher increase at the remote occupant than at the occupant in the flow path, and occupants below the line experienced a higher increase at the flow path occupant than the remote occupant. The charts shows that for the majority of the experiments, the FED at the remote occupant increased more than the occupant in the flow path inlet for the same experiment. In some experiments, the total toxic dose sustained by a potentially trapped occupant increased by several times the incapacitating dose (FED = 1.0). The notable outlier in this trend is Experiment 5, denoted by the green marker in the lower right-hand corner of the chart. In this experiment, the magnitude of the CO concentrations were considerably higher

at the time of intervention than the remote bedroom (13300 compared to 6100), resulting in the higher FED.

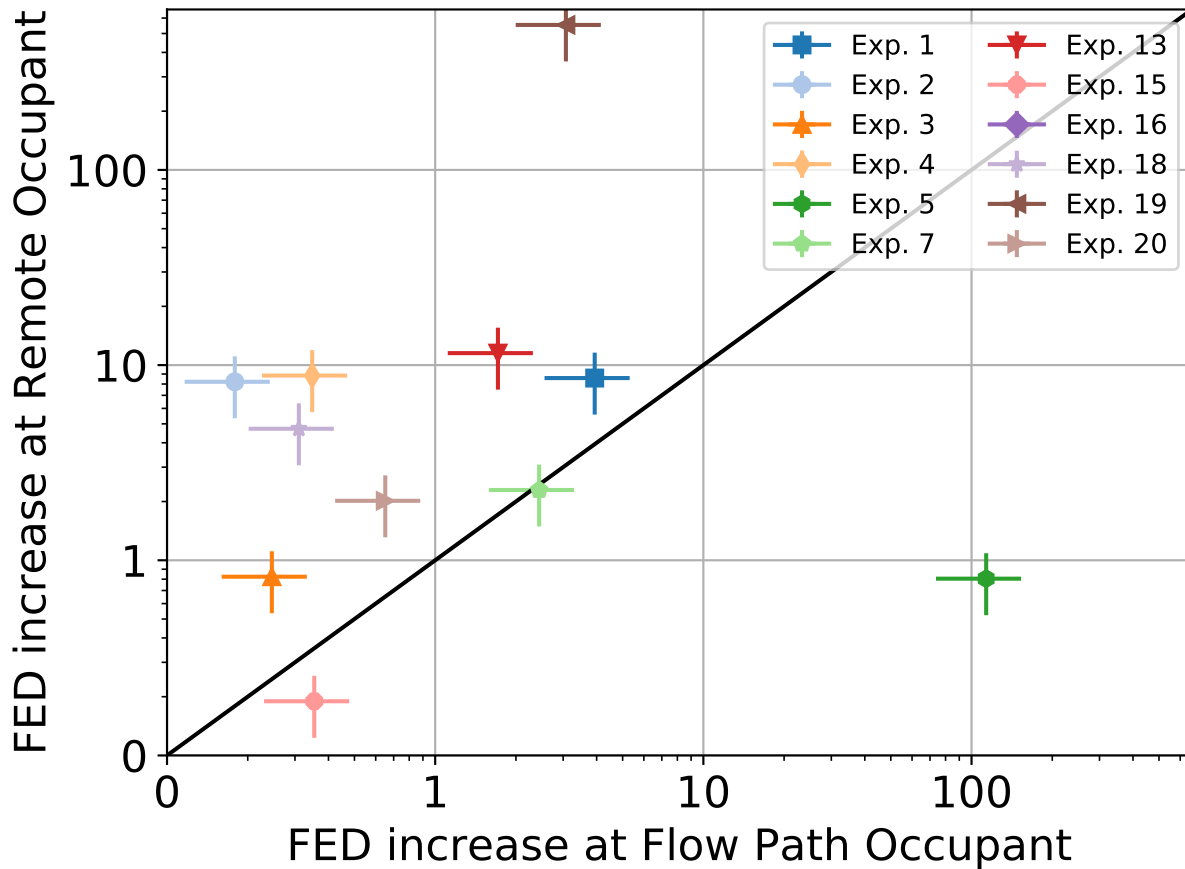

Figure 5.21: Increase in FED from opening of front door until end of experiment. Y-axis shows increase in FED for the remote occupant while x-axis shows increase in FED for occupant located within flow path. Values are shown on a log-log scale to account for differing FED magnitudes between structures. Experiments where 1 ft gas concentrations were negligible or experienced a sensor error were omitted (Experiments 6, 8, 9, 10, 11, 12, 14, and 17).

Consider Experiments 1 and 3 in particular. Both of these experiments were conducted in the same house, with Experiment 1 having no additional ventilation and Experiment 3 having post-suppression vertical ventilation over the fire room (Figure 5.22). Although vertical ventilation was performed in Experiment 3, which quickly improved conditions in the hallway and fire room, the only gas exchange occurring in the remote bedroom is through the fire room doorway, so gas concentrations and resultant toxic dose did not improve as quickly, resulting in the longer time to peak FER and higher FED accumulated in the remote bedroom, as illustrated in Figures 5.20 and 5.21.

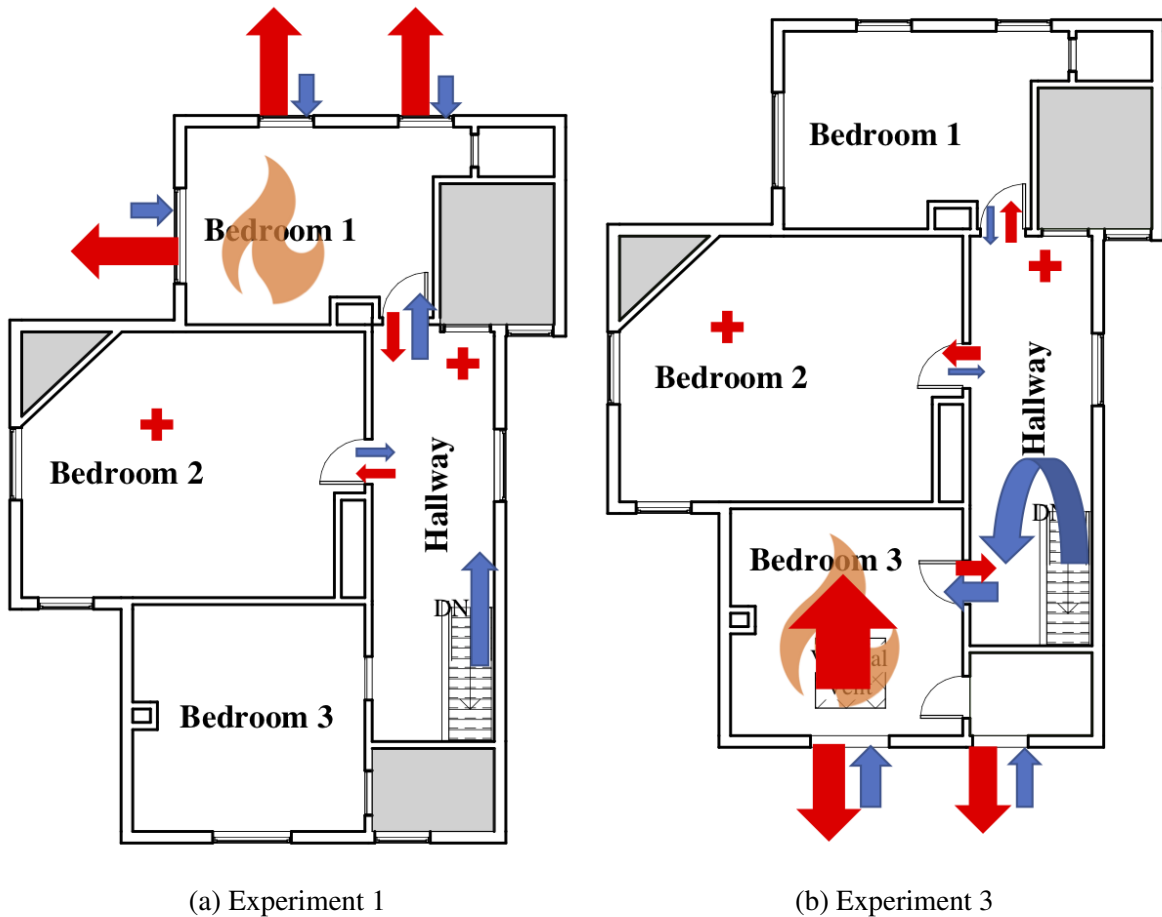
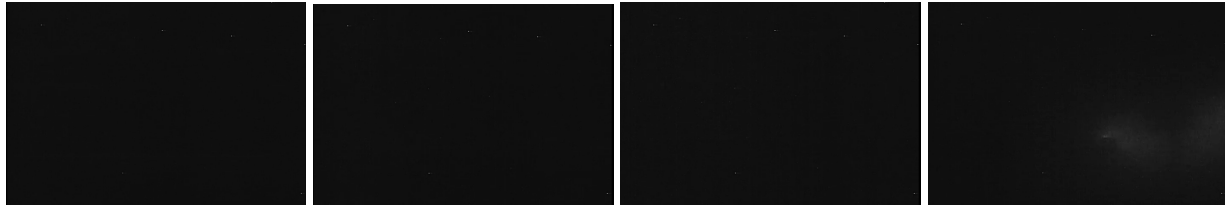
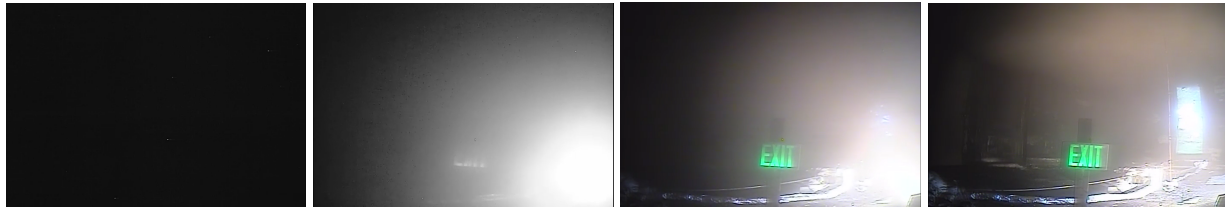

Figure 5.22: Comparison of flow path after opening of front door in Experiment 1 with flow path after vertical ventilation in Experiment 3.

In the experiments in which horizontal ventilation was performed at any available opening, gas concentrations, visibility, and skin burn assessment package temperatures dropped at a more rapid rate than in experiments where no local ventilation was performed. This effect is most dramatically demonstrated by the improvement in visibility in the remote bedroom in Experiment 12 (initial exterior suppression with additional horizontal ventilation) compared to Experiment 10 (initial exterior suppression with no additional ventilation). These two experiments were conducted on the second-floor of the same structure. Figure 5.23 shows the view from the remote bedroom camera at the start of exterior suppression, 60 s after suppression, 120 s after exterior suppression, and 240 s after suppression for Experiments 10 and 12. The images show that visibility at the floor level begins to improve within the first minute of local horizontal ventilation and continues to improve through the interior suppression actions. In the case without ventilation, on the other hand, visibility does not begin to return until nearly 4 min. after the exterior suppression action. By horizontally ventilating bedroom windows, fresh air is entrained in the same manner as when the front door is opened, reducing the gas concentrations close to the floor and improving visibility for search crews that may be operating.



(a) Experiment 10



(b) Experiment 12

Figure 5.23: Change in visibility at the remote bedroom occupant location in Experiments 10 and 12. Images show visibility at the time of intervention (left), 1 min. following exterior suppression (middle left) 2 min. following exterior suppression (middle right) and 4 min. following exterior suppression (right)

The results of these experiments showed that after effective suppression had begun, coordinated horizontal ventilation can provide benefit in areas of a structure that are otherwise remote from the flow path. The concept of coordinated local horizontal ventilation can be further extended to the tactic of Vent-Enter-Isolate-Search, which previous research has shown can improve conditions for trapped occupants when performed properly. This is an important distinction from un-coordinated, pre-suppression horizontal ventilation. When done improperly, pre-suppression horizontal ventilation has the potential to cause unwanted fire growth, which can have negative impact on firefighter safety, and occupant outcomes.

6 Future Research

The 20 experiments analyzed in this report provide a foundation for understanding the impact of different means for coordinating suppression and ventilation on a residential structure fireground. This research explored how coordinated suppression and ventilation affect fire dynamics and exposures to occupants and fire service personnel. This research focused on six first-floor kitchen fires and fourteen second-floor bedroom fires conducted in acquired residential structures.

Future research should further quantify the thermal and toxic exposure for occupants located above the fire floor in comparison to occupants located on the fire floor under a wider range of initial conditions (proximity, layout, etc.) and fire department tactics. An extension of the exterior fire control experiments with a failed ceiling would be to quantify the water dispersion (i.e., water mapping) between the two techniques addressed by this report for various construction configurations. The affect on fire dynamics and toxic exposures resulting from the failed ceiling should be further quantified.

Additional research is needed to address the limitations of this study and address the needs of the fire safety community. Further development work is needed on the skin burn assessment package to account for blood flow, sweating, etc. There is a need for an improved understanding of heat transfer to both occupants and firefighters. For firefighters, this requires more research on heat transfer into and through personal protective equipment. Lastly, more work is needed to understand the coupling of suppression and ventilation tactics with search and rescue.

7 Summary

Twenty experiments were conducted in eight different structures to analyze the coordination of suppression and ventilation tactics in single-family dwelling fires. Fourteen of the experiments allowed examination of second-floor bedroom fires, while the remaining six involved first-floor kitchen fires. Out of the fourteen bedroom fires, nine scenarios utilized interior fire control and five employed initial exterior fire control followed by interior extinguishment. Of the six kitchen fires, firefighters utilized interior fire control on three, while the other three were suppressed with exterior fire streams followed by interior extinguishment. Ventilation tactics included horizontal, vertical, positive pressure, and hydraulic ventilation. Temperature and pressure were measured throughout each structure to assess the fire dynamics, while heat flux, gas concentrations, and skin burn assessment packages were employed to assess the impact of tactics on occupant tenability.

Although differences between the structures and environmental conditions among the experiments limited the ability to make definitive, direct comparisons of tactic performance, several trends were identified that could influence tactical decisions on the fireground:

1. No meaningful increase in temperature outside the fire room was observed when ventilation tactics were executed in coordination with (shortly after or shortly before) the onset of suppression.
2. After effective suppression has begun, ventilation tactics should consider air flow within the structure, with the aim of establishing air flow through all areas where occupants may be located. In many scenarios, the most effective means to accomplish this may be the coordinated horizontal ventilation of as many windows as necessary.
3. Less than 250 gal was used during the initial suppression period and less than 500 gal was used in total for suppression for each of the 20 room-and-contents fire experiments.
4. Regrowth was observed during the one minute delay following exterior suppression in second-floor bedroom fires. On the contrary, regrowth was not observed in the one minute delay following exterior suppression on first-floor kitchen fires where more complete wetting of the room contents was possible.
5. Opening of the front door is ventilation. Even in experiments where the fire room windows and front door were the only sources of ventilation, fire growth was observed because of the more efficient flow path created as a result of front door ventilation. Additionally, the air entrained through the open front door improved conditions for potential occupants located in the flow path.

It is important to note that the appropriateness of ventilation and suppression tactics ultimately depend on local resources and circumstances of the specific incident.

Definitions

Bidirectional Vent: A building opening that simultaneously serves as both an inlet and exhaust of a flow path.

Building Sides: See Figure 7.1 for an image depicting the Alpha(A), Bravo(B), Charlie(C), and Delta(D) sides a structure.

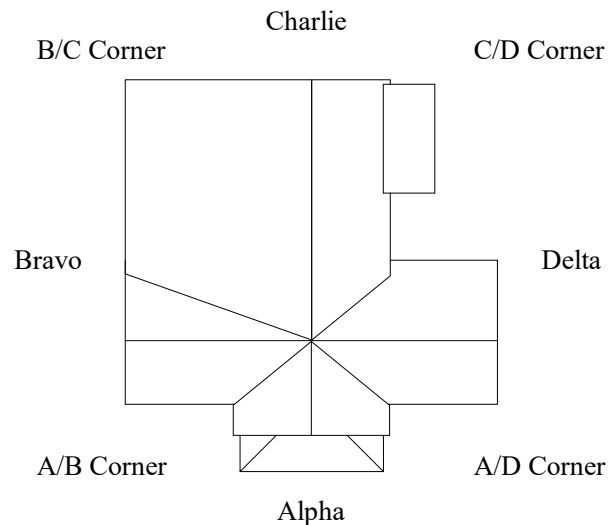

Figure 7.1: Building Side Terminology

Fire Dynamics: The detailed study of how chemistry, fire science, and the engineering disciplines of fluid mechanics and heat transfer interact to influence fire behavior [29].

Flow Path: The route followed by smoke, air, heat, or flame toward or away from an opening; typically, a window, door, or other leakage point, due to differences in pressure.

Half-Bale: In the context of a suppression action, closing the nozzle to a point between fully open and fully closed with the intention of achieving a broken stream to improve the capability of the nozzle at wetting fuel surfaces in the fire room.

Hydraulic Ventilation: Ventilation accomplished by using a spray stream to draw the smoke from a compartment through an exterior opening [30].

Immediately Dangerous to Life or Health (IDLH): Any condition that would pose an immediate or delayed threat to life, cause irreversible adverse health effects, or interfere with an individual's ability to escape unaided from a hazardous environment [31].

Inside: With respect to flow path, indicates that an occupant package was inside or close to the

inlet of a flow path that allows fresh air to move into the structure

King Stud: The vertical pieces of dimensional lumber that make up the sides of a door frame.

Lintel: The top, horizontal member of a window frame. Also referred to as a window header.

Occupant Package: A cluster of heat flux, gas concentration, and temperature sensors intended to evaluate the potential for skin burns and toxic exposure at a specific location within a structure.

Positive Pressure Attack (PPA): the use of Positive Pressure Ventilation to control the flow of products of combustion, prior to fire control, with the intent of providing increased visibility and tenability for firefighters and potential occupants while fire suppression efforts are underway [3].

Positive Pressure Ventilation (PPV): Method of ventilating a room or structure after fire control by mechanically blowing fresh air through an inlet opening into the space in sufficient volume to create a slight positive pressure within and thereby forcing the contaminated atmosphere out the exit opening [30].

Remote: With respect to flow path, indicates that an occupant package was not located in the inlet of a flow path that allows fresh air to move into the structure.

Unidirectional vent: A building opening that serves as either an inlet or exhaust of a flow path.

Ventilation: Circulation of air in any space by natural wind or convection or by fans blowing air into or exhausting air out of a building; a fire-fighting operation of removing smoke and heat from the structure by opening windows and doors or making holes in the roof [29].

Vertical Ventilation: Ventilating a point above the fire through existing or created openings and channeling the contaminated atmosphere vertically within the structure and out the top; done with openings in the roof, skylights, roof vents, or roof doors [30].

References

- [1] S. Kerber. Impact of Ventilation on Fire Behavior in Legacy and Contemporary Residential Construction. , UL Firefighter Safety Research Institute, Northbrook, IL, December 2012.
- [2] S. Kerber. Study of the Effectiveness of Fire Service Vertical Ventilation and Suppression Tactics in Single Family Homes. , UL Firefighter Safety Research Institute, Northbrook, IL, June 2013.
- [3] R Zevotek and S. Kerber. Study of the effectiveness of fire service positive pressure ventilation during fire attack in single family homes incorporating modern construction practices. Technical report, UL Firefighter Safety Research Institute, Columbia, MD, 2016.
- [4] C. Weinschenk, K. Stakes, and R. Zevotek. Impact of Fire Attack Utilizing Interior and Exterior Streams on Firefighter Safety and Occupant Survival: Water Mapping. Technical report, UL Firefighter Safety Research Institute, Columbia, Maryland, December 2017.
- [5] C. Weinschenk, K. Stakes, and R. Zevotek. Impact of Fire Attack Utilizing Interior and Exterior Streams on Firefighter Safety and Occupant Survival: Air Entrainment. Technical report, UL Firefighter Safety Research Institute, Columbia, Maryland, December 2017.
- [6] R. Zevotek, K. Stakes, and J. Willi. Impact of Fire Attack Utilizing Interior and Exterior Streams on Firefighter Safety and Occupant Survival: Full-Scale Experiments. Technical report, UL Firefighter Safety Research Institute, Columbia, Maryland, January 2018.
- [7] L.G. Blevins. Behavior of bare and aspirated thermocouples in compartment fires. In *National Heat Transfer Conference, 33rd Proceedings*, pages 15–17, 1999.
- [8] W.M. Pitts, E. Braun, R. Peacock, H. Mitler, E. Johnson, P. Reneke, and L.G. Blevins. Temperature uncertainties for bare-bead and aspirated thermocouple measurements in fire environments. *ASTM Special Technical Publication*, 1427:3–15, 2003.
- [9] S. Kerber and D. Madrzykowski. Evaluating Positive Pressure Ventilation In Large Structures: School Pressure and Fire Experiments. NISTTN 1498, National Institute of Standards and Technology, Gaithersburg, Maryland, 2008.
- [10] W.M. Pitts, A.V. Murthy, J.L. de Ris, J. Filtz, K. Nygård, D. Smith, and I. Wetterlund. Round robin study of total heat flux gauge calibration at fire laboratories. *Fire Safety Journal*, 41(6):459–475, 2006.
- [11] M. Bundy, A. Hamins, E.L. Johnsson, S.C. Kim, G.H. Ko, and D.B. Lenhart. Measurements of Heat and Combustion Products in Reduced-Scale Ventilated-Limited Compartment Fires. NIST Technical Note 1483, National Institute of Standards and Technology, Gaithersburg, MD, 2007.

- [12] A. Lock, M. Bundy, E.L. Johnsson, A. Hamins, G.H. Ko, C. Hwang, P. Fuss, and R. Harris. Experimental study of the effects of fuel type, fuel distribution, and vent size on full-scale underventilated compartment fires in an ISO 9705 room. NIST Technical Note 1603, National Institute of Standards and Technology, Gaithersburg, MD, 2008.
- [13] D.A. Purser. *SFPE Handbook of Fire Protection Engineering*, chapter Assessment of Hazards to Occupants from Smoke, Toxic Gases, and Heat. National Fire Protection Association, Quincy, Massachusetts, 5th edition, 2016.
- [14] D.A. Purser. *Fire Toxicity*, chapter Asphyxiant components of fire effluents. Woodhead Publishing, Cambridge, UK, 2010.
- [15] N. Traina, R. Kesler, S. Kerber, R. Zevotek, T. Lee, and G. Horn. Ex-Vivo Porcine Skin Model for Estimation of Trapped Occupant Burn Risk in Pre-and Post-suppression Fire Environments. *Fire Technology*, 55(6):2465–2489, 2019.
- [16] A. Moritz and F. Henriques Jr. Studies of thermal injury: Ii. the relative importance of time and surface temperature in the causation of cutaneous burns. *The American Journal of Pathology*, 23(5):695, 1947.
- [17] F. Henriques Jr. Studies of Thermal Injury, V: The predictability and Significance of Thermally Induced Rate Processes Leading to Irreversible Epidermal Injury Archives of Pathology. *Archives of Pathology*, 43:489–502, 1947.
- [18] A. Stoll and L. Greene. Relationship between pain and tissue damage due to thermal radiation. *Journal of Applied Physiology*, 14(3):373–382, 1959.
- [19] H. Utech. Status report on research programs for firefighters protective clothing. In *Proceedings of the Fire Department Instructor’s Conference*, Indianapolis, Indiana, 1973.
- [20] NFPA 1971. *Standard on Protective Ensembles for Structural Fire Fighting and Proximity Fire Fighting*. National Fire Protection Association, Quincy, Massachusetts, 2018.
- [21] NFPA 1981. *Standard on Open-Circuit Self-Contained Breathing Apparatus (SCBA) for Emergency Services*. National Fire Protection Association, Quincy, Massachusetts, 2013.
- [22] A. Putorti, A. Mensch, N. Bryner, and G. Braga. Thermal Performance of Self-Contained Breathing Apparatus Facepiece Lenses Exposed to Radiant Heat Flux. Technical Report NIST TN 1785, National Institute of Standards and Technology, Gaithersburg, MD, 2013.
- [23] R. Kesler, C. Mitsingas, A. Quiat, T. Lee, D. Madrzykowski, and G. Horn. Mechanical properties and off-gassing characteristics of new and legacy facepieces. NISTGCR 18-019, 2018.
- [24] G. Horn, R. Kesler, J. Regan, and D. Madrzykowski. A Study on the Effect of Repeat Moderate Intensity Radiant Exposures on SCBA Facepiece Properties. NISTGCR 17-014, 2017.
- [25] D. Madrzykowski. Fire Fighter Equipment Operational Environment: Evaluation of Thermal Conditions. Technical report, UL Firefighter Safety Research Institute, Columbia, Maryland, August 2017.

- [26] Center for Disease Control and Prevention (CDC), Atlanta, Georgia. *630-08-0: Carbon Monoxide*, 2014.
- [27] S. Kerber, J.W. Regan, G. Horn, K. Fent, and D. Smith. Effect of Firefighting Intervention on Occupant Tenability During a Residential Fire. *Fire Technology*, 55(6):2289–2316, 2019.
- [28] National Fire Protection Association, Quincy, Massachusetts. *NFPA 1901, Standard for Automotive fire Apparatus*, 2016.
- [29] NFPA 921. *Guide for Fire and Explosion Investigations*. National Fire Protection Association, Quincy, Massachusetts, 2017.
- [30] International Fire Service Training Association. *Essentials of Fire Fighting and Fire Department Operations*. Fire Protection Publications, Stillwater, OK, 7th edition, 2019.
- [31] NFPA 1670. *Standard on Operations and Training for Technical Search and Rescue Incidents*. National Fire Protection Association, Quincy, Massachusetts, 2017.
- [32] B.N. Taylor and C.E. Kuyatt. Guidelines for Evaluating and Expressing the Uncertainty of NIST Measurement Results. NIST Technical Note 1297, National Institute of Standards and Technology, Gaithersburg, Maryland, 1994.
- [33] Badger Meter. M-series m2000 product data sheet (mag-ds-01047-en). Date Accessed: October 2019 <https://www.badgermeter.com/business-lines/flow-instrumentation/m2000/>.

Appendix A Water Flow Uncertainty

Uncertainty is grouped into two types of analysis: Type A and Type B. Type A uncertainties are those evaluated by statistical methods while Type B uncertainties are those evaluated by other means [32].

Water flow data obtained during each of the 20 experiments was analyzed to determine the Type A uncertainty associated with such measurements. Noise exists in the raw data due to natural movement in the fluid due to external forces such as: physically moving the flow meter, pump output, or supply variability. By evaluating the data taken during each experiment a total uncertainty for this measurement can be developed.

Manufacturer specifications indicate that the flow meter has an accuracy of 0.2% and a repeatability of 0.1% [33]. To measure water flow rate, these meters are designed to be attached to stationary fluid pipe. For these experiments, the flow meters were installed between couplings on hoses, therefore impacting the accuracy and repeatability of measurements. Hoses are not stationary and can move significantly from hose advancement and the flow of water. The desired flow rate from each hose was 150 gpm. To ensure the actual flow was within an acceptable range, ± 5 gpm, the flow rate was verified from the flow meter prior to ignition. The discharge pressure was adjusted at the pump panel of the engine until the measurement provided from each individual flow meter was within the acceptable range.

For this analysis, a flow was defined as measured flowrate greater than 25 gpm for a minimum of 3 s. This analysis excluded any water used during mop-up operations. The flow had to remain steady for a minimum of 6 s with the bale fully open. Steady flow was defined as a maximum change in flow of ± 10 gpm between each time step. The bale was considered fully open if the flow rate was at least 80% of 150 gpm (i.e., flowing at minimum 120 gpm).

The average flow rate for all flows within each experiment was calculated. The average flow rate for all flows was determined to be 149.7 gpm with a range of -16 gpm to +14 gpm. Using the maximum deviation (16 gpm) the total expanded uncertainty associated with water flow measurements was estimated to be $\pm 11\%$.

Appendix B Architectural Drawings

Detailed architectural drawings for each of the structures used in this experimental series are included here. Each figure is a single floor of the respective floor and dimensions are presented in both the U.S. customary and metric systems.

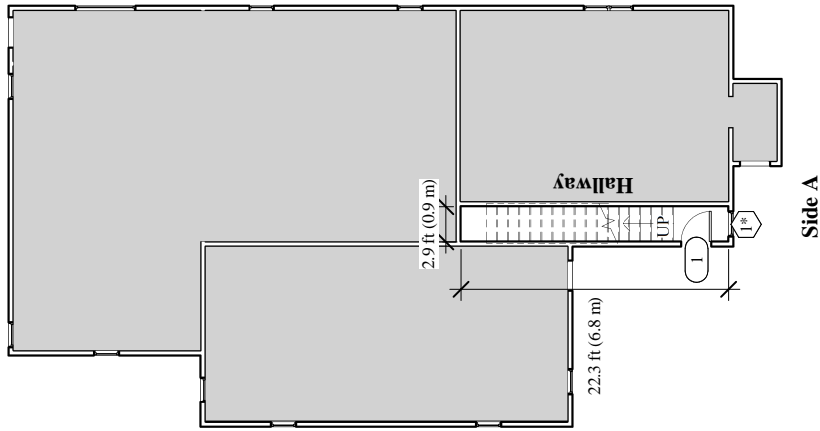

- Item Description
- X Door Identification Tag
 - Window Identification Tag
 - Area used for instrumentation

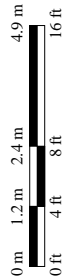

First Floor Door Schedule			
Mark	Height	Width	Area
1	6.7 ft	2.5 ft	2.0 m

First Floor Window Schedule			
Mark	Sill Height	Height	Width
1*	1.8 ft	5.7 ft	2.1 ft

*Indicates window was protected with drywall during all experiments

First Floor Room Schedule			
Name	Area	Volume	Area
Hallway	65.2 ft ²	612.8 ft ³	6.1 m ²
Grand total	65.2 ft ²	612.8 ft ³	6.1 m ²

Figure B.1: 201/203 Water Street, Sidney, OH: 1st Floor Architectural Layout

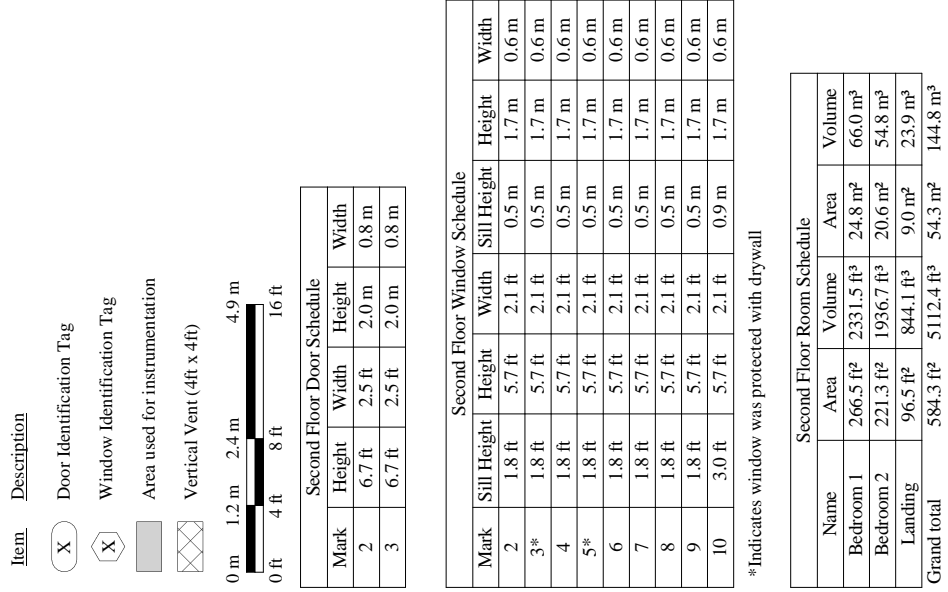

Figure B.2: 201/203 Water Street, Sidney, OH: 2nd Floor Architectural Layout

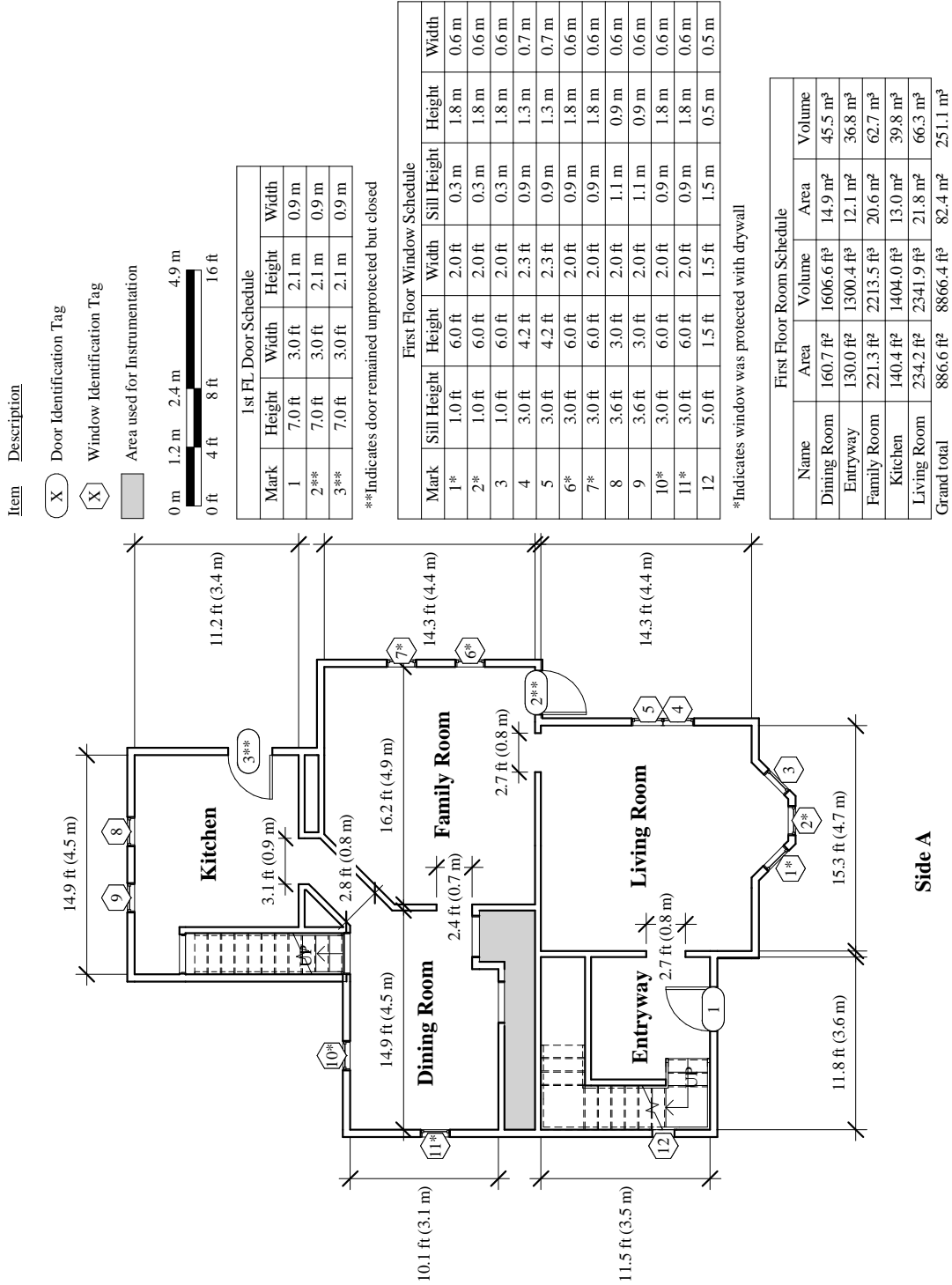

Figure B.3: 230 North, Walnut Street, Sidney, OH: 1st Floor Architectural Layout

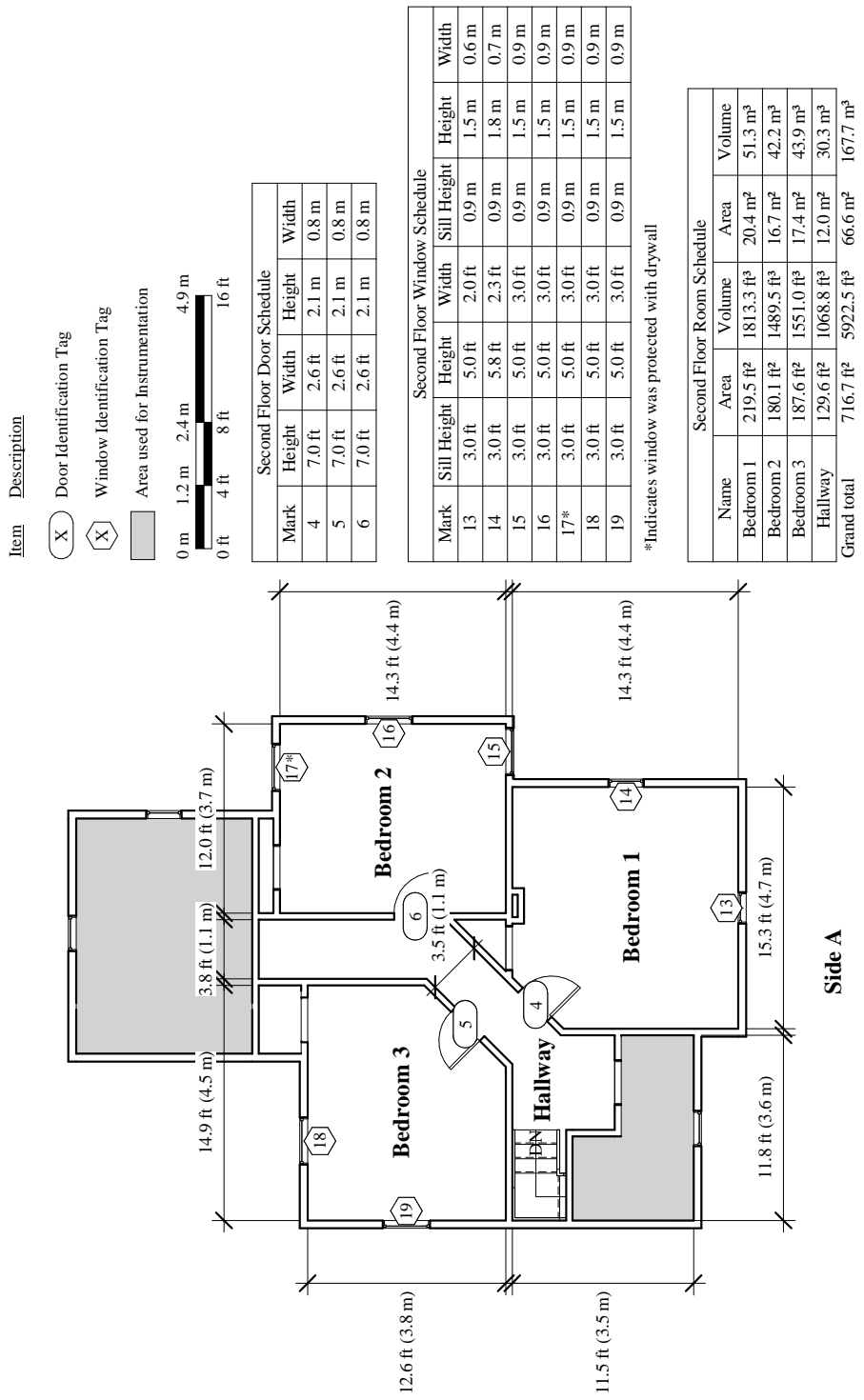
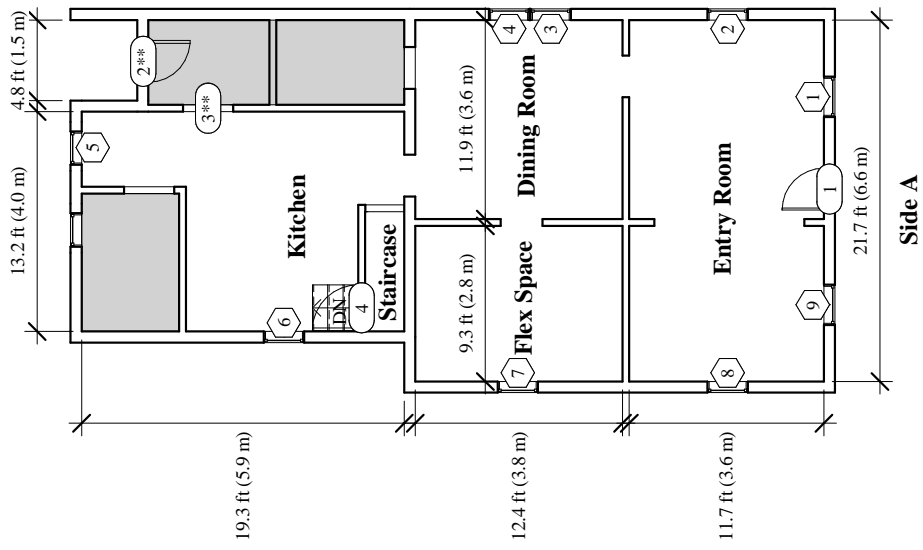

Figure B.4: 230 North Walnut Street, Sidney, OH: 2nd Floor Architectural Layout



- Item Description**
- (X) Door Identification Tag
 - (X) Window Identification Tag
 - Area used for instrumentation

First Floor Door Schedule

Mark	Height	Width	Height	Width
1	6.7 ft	2.5 ft	2.0 m	0.8 m
2**	6.7 ft	2.5 ft	2.0 m	0.8 m
3**	7.0 ft	3.0 ft	2.1 m	0.9 m

First Floor Window Schedule

Mark	Sill Height	Height	Width	Sill Height	Height	Width
1	2.1 ft	5.9 ft	2.4 ft	0.6 m	1.8 m	0.7 m
2	2.1 ft	5.9 ft	2.4 ft	0.6 m	1.8 m	0.7 m
3	2.1 ft	5.9 ft	2.4 ft	0.6 m	1.8 m	0.7 m
4	2.1 ft	5.9 ft	2.4 ft	0.6 m	1.8 m	0.7 m
5	4.7 ft	2.5 ft	2.0 ft	1.4 m	0.8 m	0.6 m
6	2.1 ft	5.9 ft	2.4 ft	0.6 m	1.8 m	0.7 m
7	2.1 ft	5.9 ft	2.4 ft	0.6 m	1.8 m	0.7 m
8	2.1 ft	5.9 ft	2.4 ft	0.6 m	1.8 m	0.7 m
8	7.0 ft	1.5 ft	1.3 ft	2.1 m	0.5 m	0.4 m
9	2.1 ft	5.9 ft	2.4 ft	0.6 m	1.8 m	0.7 m

**Indicates door remained unprotected but closed

First Floor Room Schedule

Name	Area	Volume	Area	Volume
Dining Room	149.9 ft²	1287.9 ft³	13.9 m²	36.5 m³
Entry Room	252.2 ft²	2164.7 ft³	23.4 m²	61.3 m³
Flex Space	116.4 ft²	999.1 ft³	10.8 m²	28.3 m³
Kitchen	180.5 ft²	1565.2 ft³	16.8 m²	44.3 m³
Staircase	16.8 ft²	167.7 ft³	1.6 m²	4.7 m³
Grand total	715.9 ft²	6184.5 ft³	66.5 m²	175.1 m³

Figure B.5: 732 Broadway Ave., Sidney, OH: 1st Floor Architectural Layout

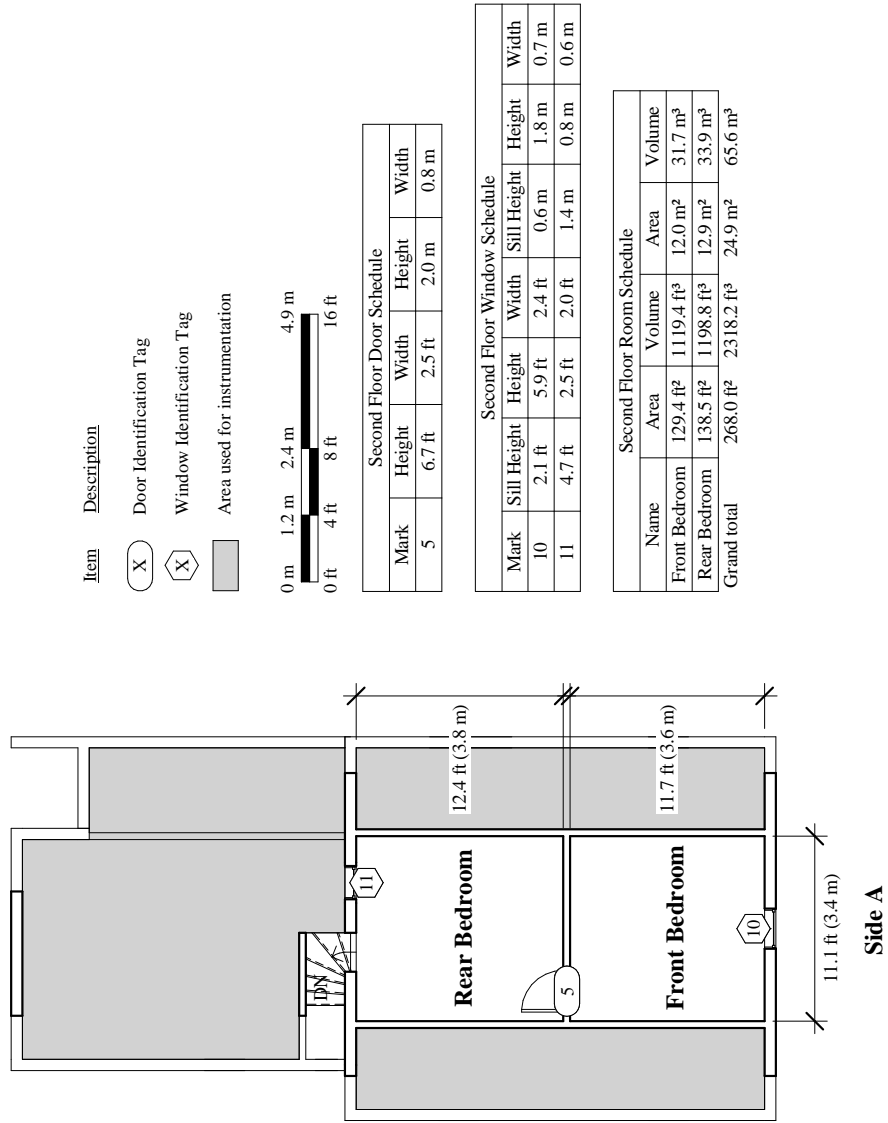

Figure B.6: 732 Broadway Ave., Sidney, OH: 2nd Floor Architectural Layout

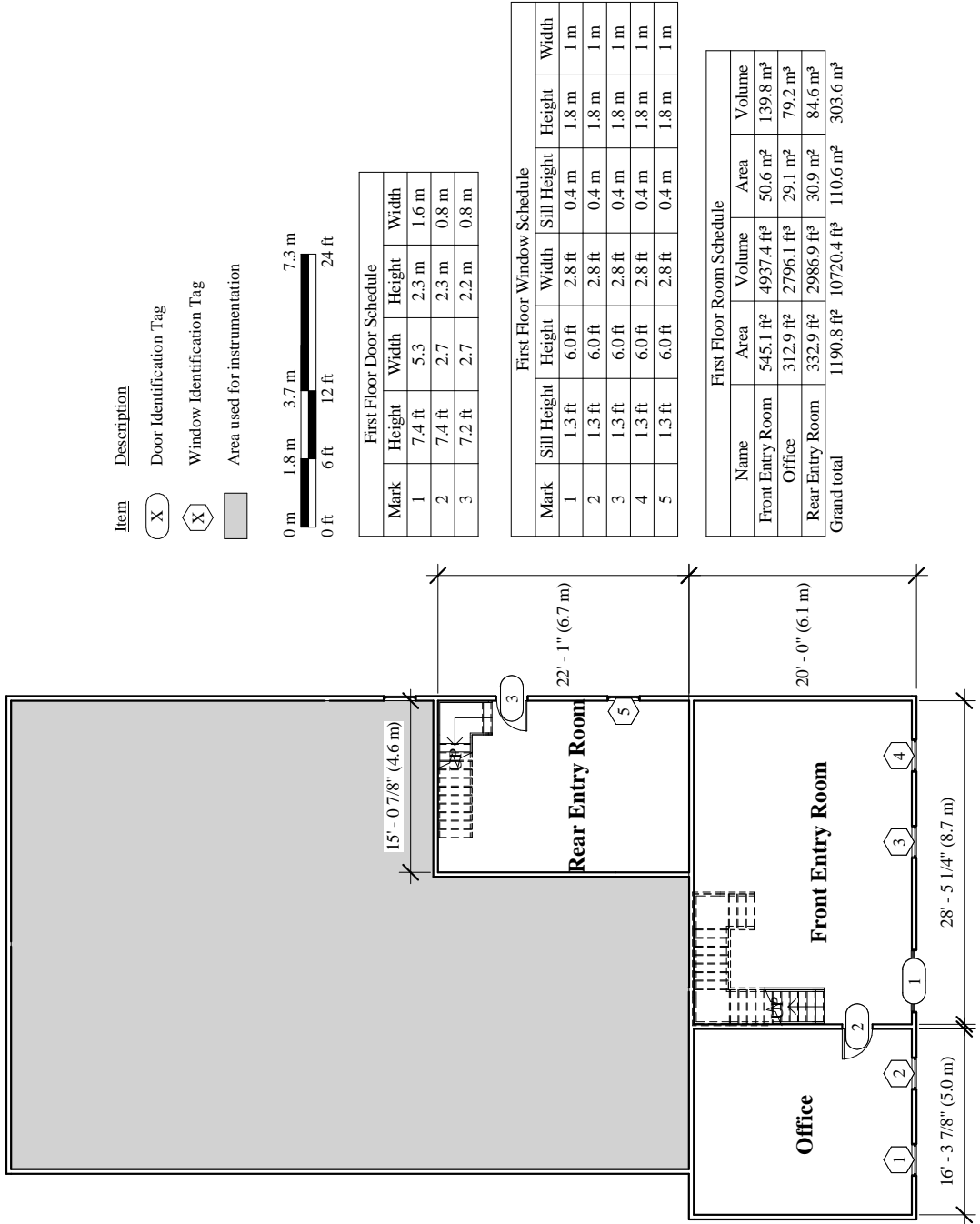
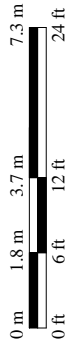
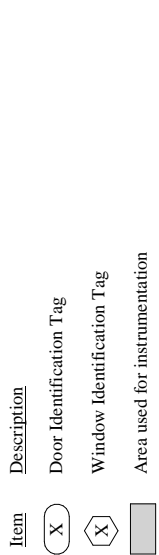

Figure B.7: 2401 Wapakoneta Ave., Sidney, OH: 1st Floor Architectural Layout



Second Floor Door Schedule			
Mark	Height	Width	Width
4*	7.4 ft	2.7	0.8 m

*Indicates door was protected with drywall

Second Floor Window Schedule					
Mark	Sill Height	Height	Width	Sill Height	Width
6*	1.3 ft	6.0 ft	2.8 ft	0.4 m	1.8 m
7*	1.3 ft	6.0 ft	2.8 ft	0.4 m	1.8 m
8	1.3 ft	6.0 ft	2.8 ft	0.4 m	1.8 m
9	1.3 ft	6.0 ft	2.8 ft	0.4 m	1.8 m
10	1.3 ft	6.0 ft	2.8 ft	0.4 m	1.8 m
11	1.3 ft	6.0 ft	2.8 ft	0.4 m	1.8 m
12	1.3 ft	6.0 ft	2.8 ft	0.4 m	1.8 m
13	1.3 ft	6.0 ft	2.8 ft	0.4 m	1.8 m
14	3.0 ft	4.0 ft	3.0 ft	0.9 m	1.2 m
15	3.0 ft	4.0 ft	3.0 ft	0.9 m	1.2 m
16	3.0 ft	4.0 ft	3.0 ft	0.9 m	0.9 m

Second Floor Room Schedule				
Name	Area	Volume	Area	Volume
Bedroom 1	313.4 ft²	3123.3 ft³	29.1 m²	88.4 m³
Bedroom 2	313.4 ft²	3123.3 ft³	29.1 m²	88.4 m³
Bedroom 3	266.5 ft²	2614.2 ft³	24.8 m²	74.0 m³
Bedroom 4	188.3 ft²	1849.8 ft³	17.5 m²	52.4 m³
Landing	162.2 ft²	1619.5 ft³	15.1 m²	45.9 m³
Staircase	48.9 ft²	489.0 ft³	4.5 m²	13.8 m³
Grand total	1292.7 ft²	12818.9 ft³	120.1 m²	363.0 m³

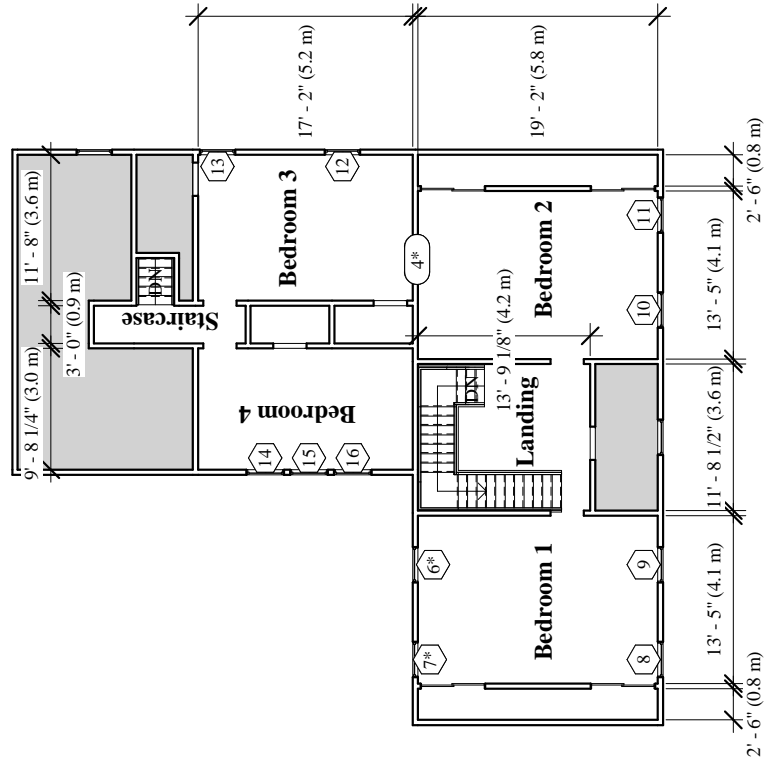

Side A

Figure B.8: 2401 Wapakoneta Ave., Sidney, OH: 2nd Floor Architectural Layout

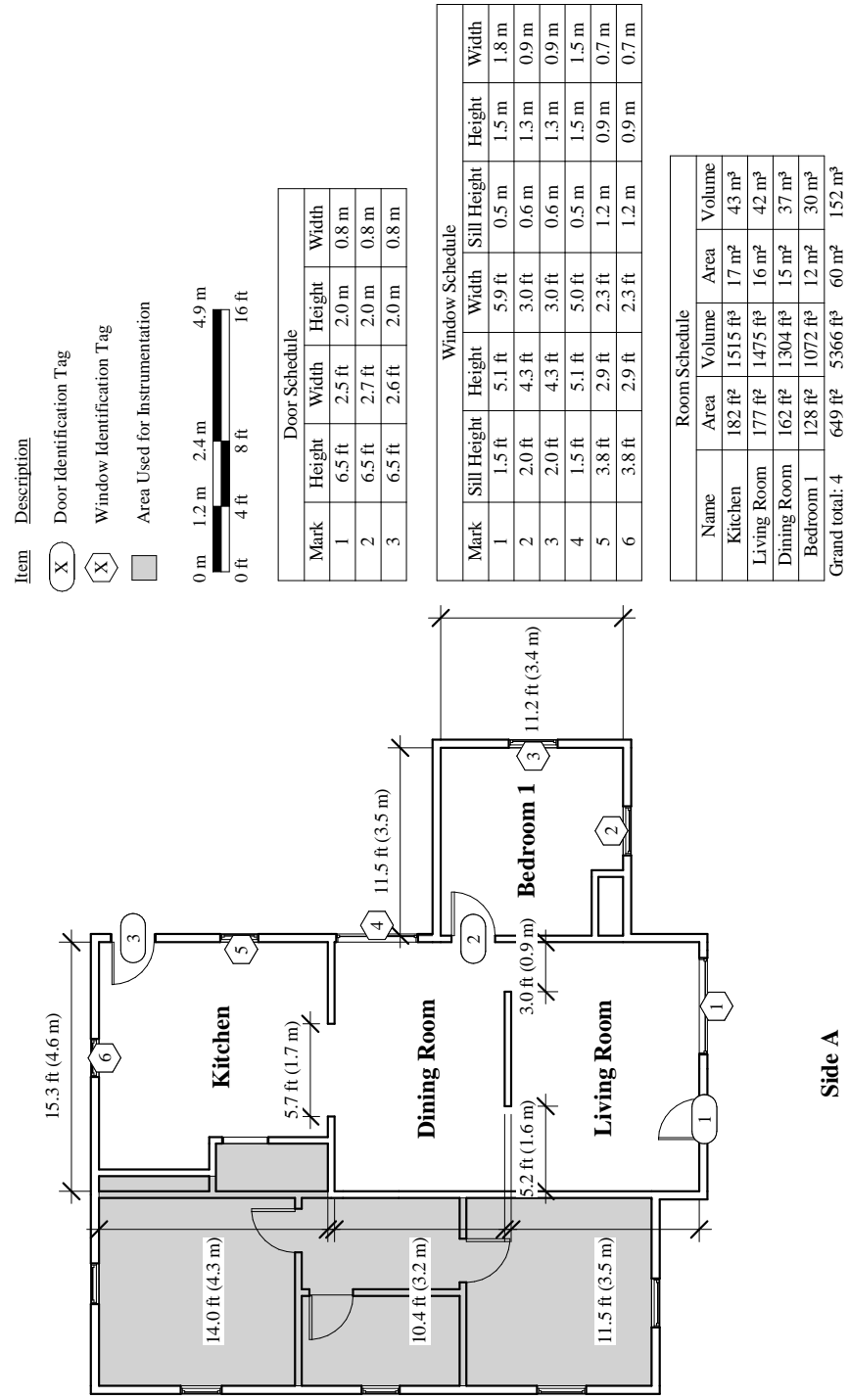
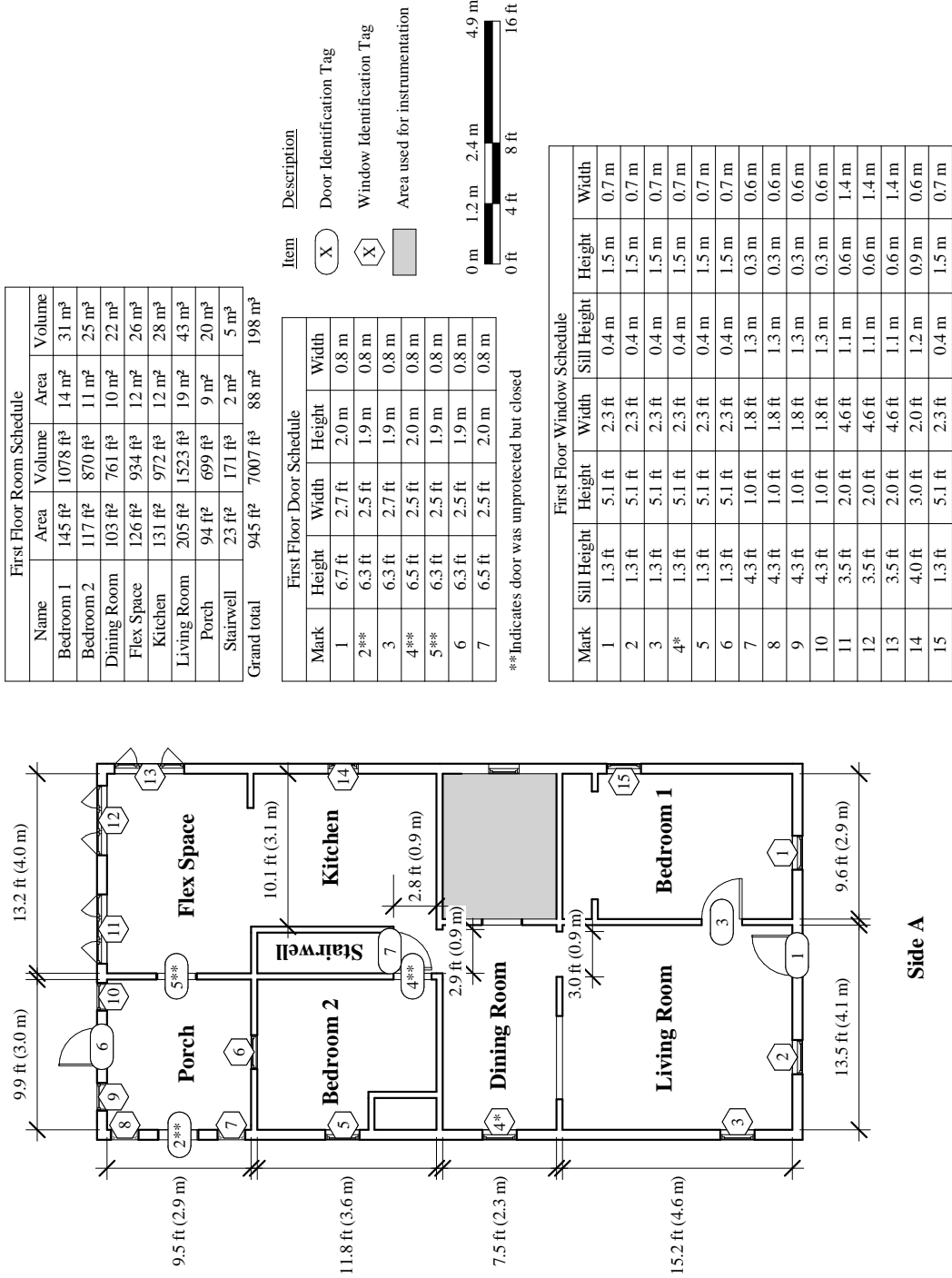

Figure B.9: 773 Hilltop Rd., Xenia, OH: Architectural Floor Plan



**Indicates door was unprotected but closed

*Indicates window was protected with plywood

Figure B.10: 775 Hilltop Rd., Xenia, OH: 1st Floor Architectural Floor Plan

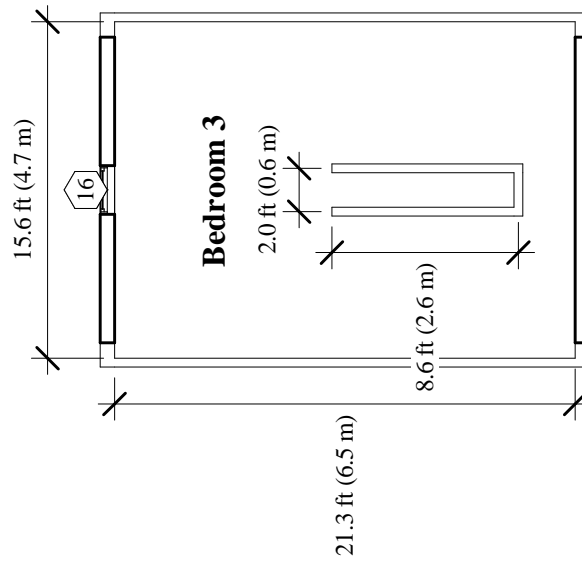

Second Floor Room Schedule			
Name	Area	Volume	Volume
Bedroom 3	325 ft ²	1841 ft ³	52 m ³
Grand total	325 ft ²	1841 ft ³	52 m ³

Second Floor Window Schedule					
Mark	Sill Height	Height	Width	Sill Height	Width
16	2.0 ft	3.2 ft	2.3 ft	0.6 m	0.7 m

Item Description



Window Identification Tag

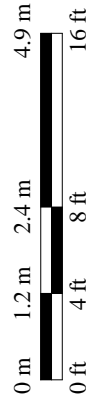
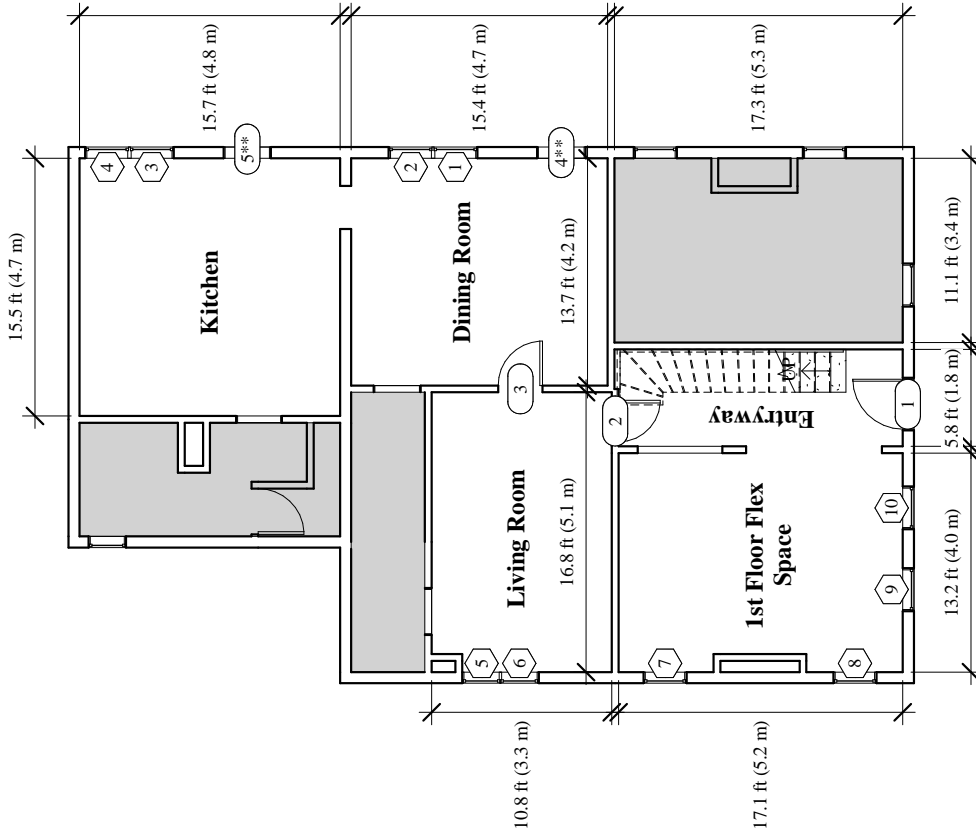

Figure B.11: 775 Hilltop Rd., Xenia, OH: 2nd Floor Architectural Floor Plan



- | Item | Description |
|------|-------------------------------|
| (X) | Door identification tag |
| (X) | Window identification tag |
| ■ | Area used for instrumentation |
- 0 m 1.2 m 2.4 m 4.9 m
0 ft 4 ft 8 ft 16 ft

First Floor Door Schedule			
Mark	Height	Width	Width
1	7.0 ft	3.0 ft	2.1 m
2	6.5 ft	2.5 ft	2.0 m
3	6.5 ft	2.7 ft	2.0 m
4**	6.5 ft	2.8 ft	2.0 m

** Indicates door remained unprotected but closed

First Floor Window Schedule					
Mark	Sill Height	Height	Width	Sill Height	Width
1	2.8 ft	5.0 ft	2.7 ft	0.8 m	0.8 m
2	2.8 ft	5.0 ft	2.7 ft	0.8 m	0.8 m
3	3.0 ft	5.1 ft	2.7 ft	0.9 m	0.8 m
4	3.0 ft	5.1 ft	2.7 ft	0.9 m	0.8 m
5	2.4 ft	5.3 ft	2.3 ft	0.7 m	0.7 m
6	2.4 ft	5.3 ft	2.3 ft	0.7 m	0.7 m
7	2.5 ft	5.4 ft	2.6 ft	0.8 m	0.8 m
8	2.5 ft	5.4 ft	2.6 ft	0.8 m	0.8 m
9	2.5 ft	5.4 ft	2.6 ft	0.8 m	0.8 m
10	2.5 ft	5.4 ft	2.6 ft	0.8 m	0.8 m

First Floor Room Schedule			
Name	Area	Volume	Volume
1st Floor Flex Space	220.6 ft²	2007.9 ft³	20.5 m²
Dining Room	211.6 ft²	1926.2 ft³	19.7 m²
Entryway	101.9 ft²	949.5 ft³	9.5 m²
Kitchen	243.7 ft²	1991.1 ft³	22.6 m²
Living Room	180.3 ft²	1641.1 ft³	16.7 m²
Grand total	958.0 ft²	8515.9 ft³	89.0 m²
			241.1 m³

Side A

Figure B.12: 1030 Hilltop Rd., Xenia, OH: 1st Floor Architectural Floor Plan

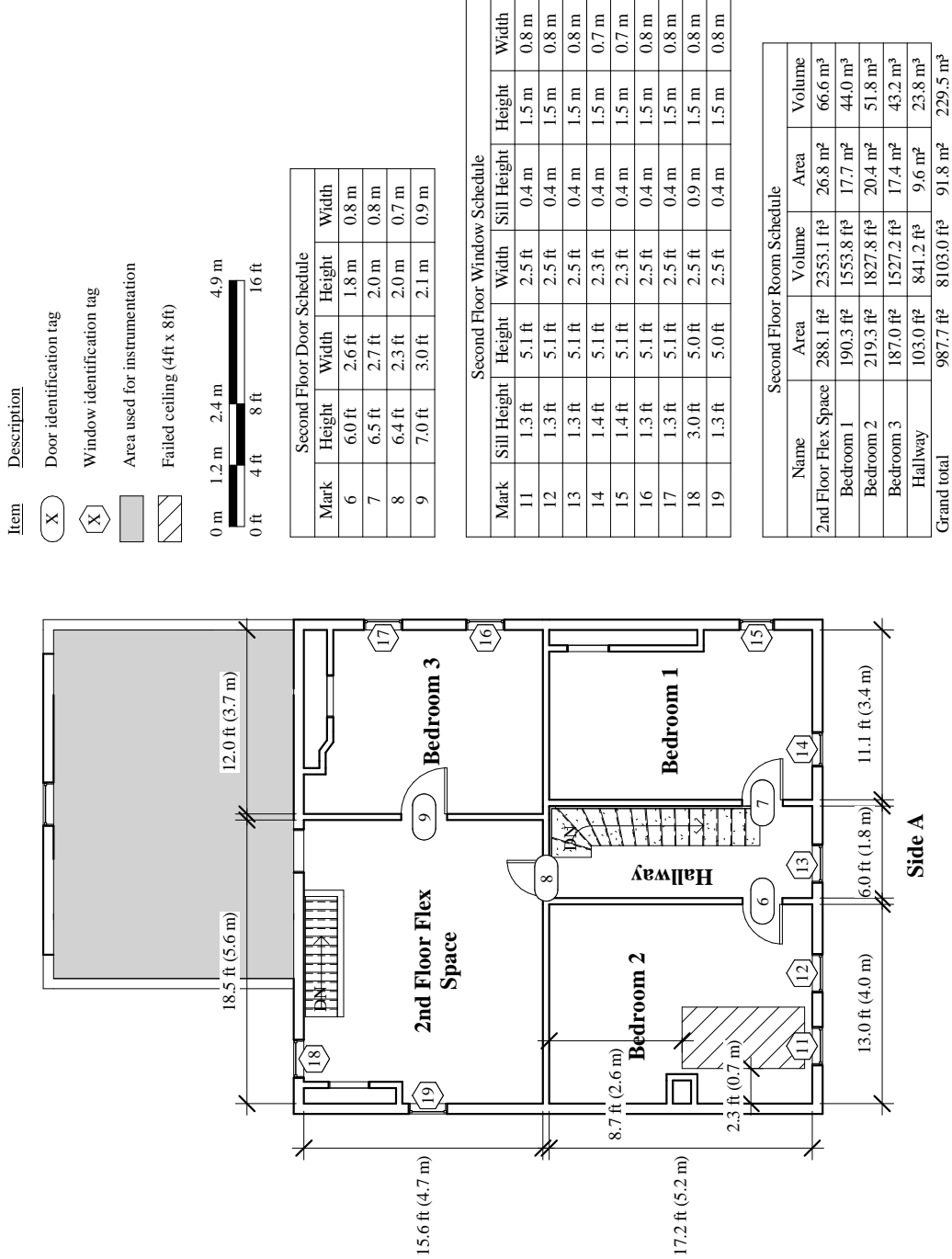

Figure B.13: 1030 Hilltop Rd., Xenia, OH: 2nd Floor Architectural Floor Plan

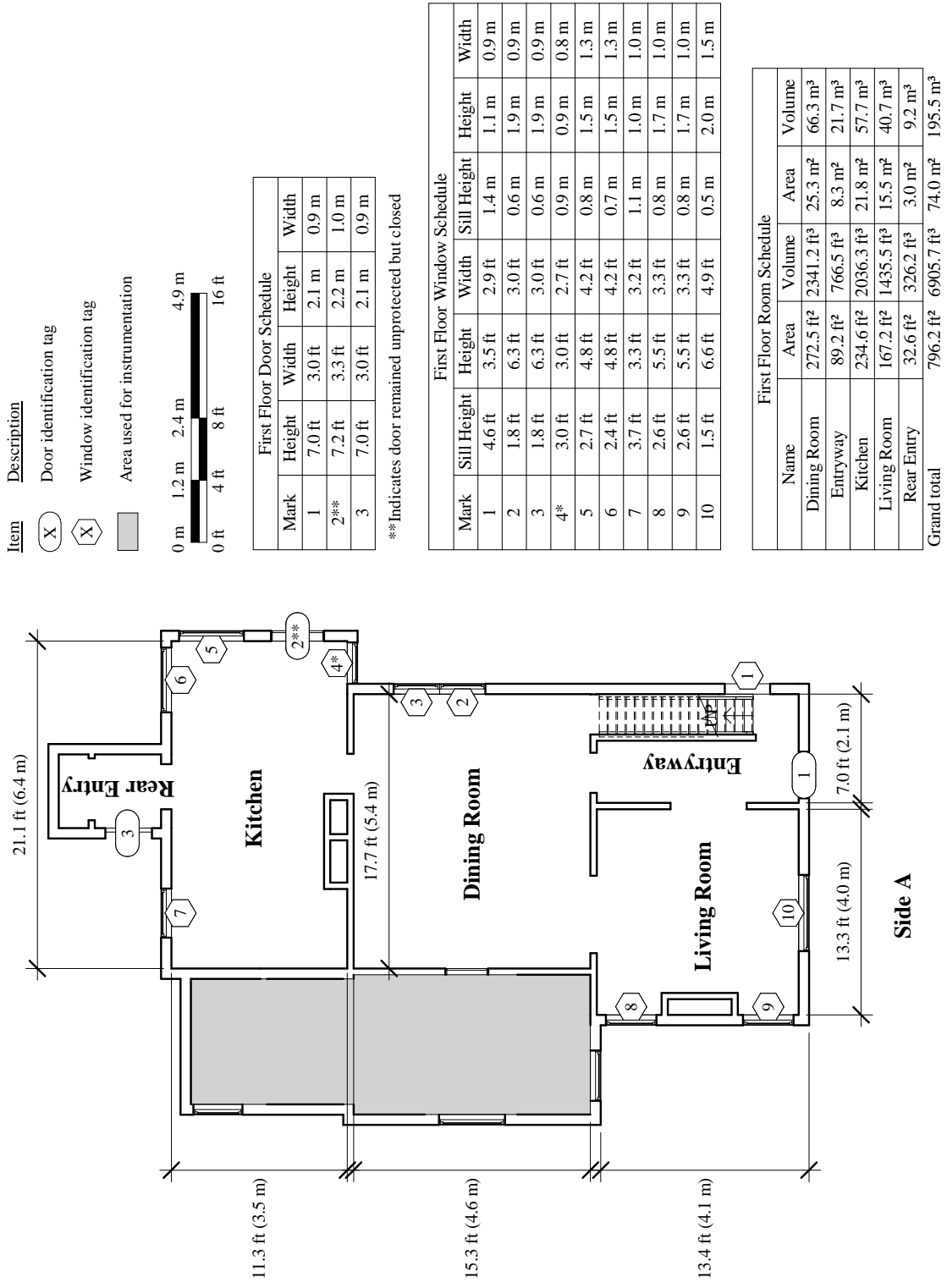
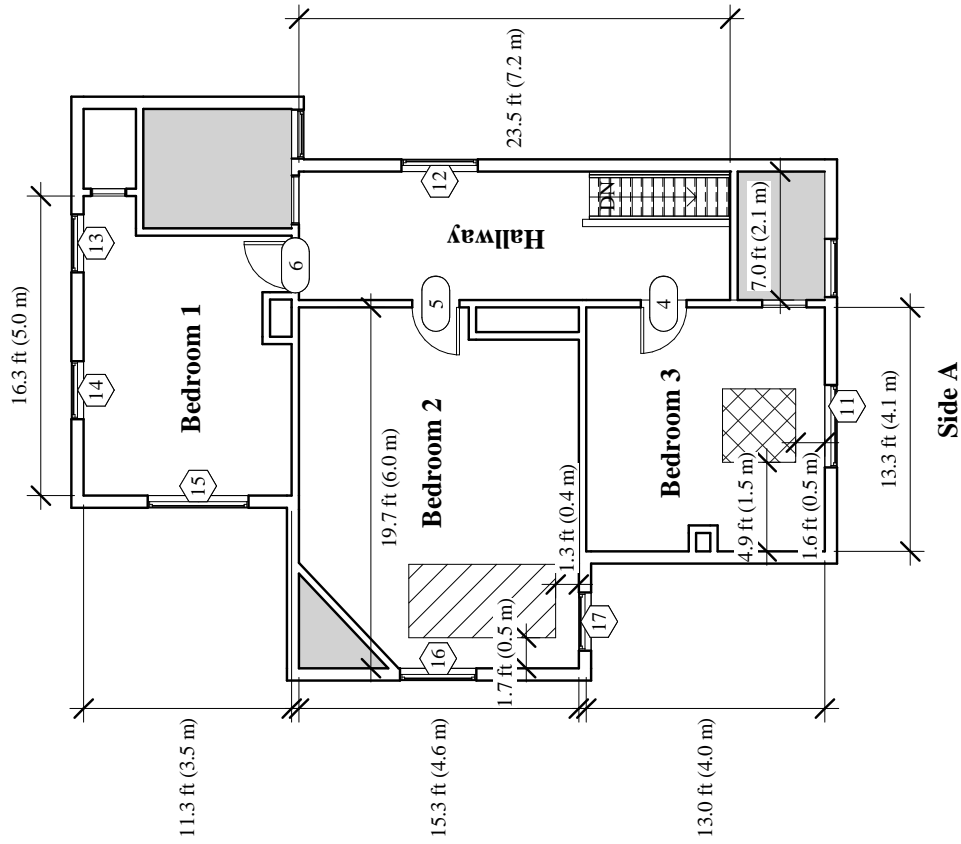

Figure B.14: 1492 Dayton Xenia Rd., Xenia, OH: 1st Floor Architectural Floor Plan



Item **Description**

(X) Door identification tag

(X) Window identification tag

■ Area used for instrumentation

▨ Failed ceiling (8ft x 4ft)

⊠ Vertical vent (4ft x 4ft)

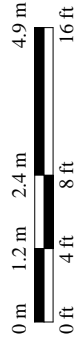

Second Floor Door Schedule			
Mark	Height	Width	Width
4	6.7 ft	2.5 ft	2.0 m
5	6.5 ft	2.6 ft	2.0 m
6	6.4 ft	2.6 ft	2.0 m

Second Floor Window Schedule					
Mark	Sill Height	Height	Width	Sill Height	Height
11	1.3 ft	5.9 ft	4.5 ft	0.4 m	1.8 m
12	1.3 ft	5.9 ft	4.2 ft	0.4 m	1.8 m
13	1.3 ft	5.9 ft	3.2 ft	0.4 m	1.8 m
14	1.3 ft	5.9 ft	3.2 ft	0.4 m	1.8 m
15	3.3 ft	3.4 ft	5.5 ft	1.0 m	1.7 m
16	1.3 ft	5.9 ft	4.2 ft	0.4 m	1.8 m
17	1.3 ft	5.9 ft	3.2 ft	0.4 m	1.8 m

Second Floor Room Schedule				
Name	Area	Volume	Area	Volume
Bedroom 1	175.7 ft ²	1347.3 ft ³	16.3 m ²	38.2 m ³
Bedroom 2	273.8 ft ²	2101.5 ft ³	25.4 m ²	59.5 m ³
Bedroom 3	170.8 ft ²	1323.8 ft ³	15.9 m ²	37.5 m ³
Entryway	89.2 ft ²	766.5 ft ³	8.3 m ²	21.7 m ³
Hallway	161.2 ft ²	1249.8 ft ³	15.0 m ²	35.4 m ³
Grand total	870.8 ft ²	6788.9 ft ³	80.9 m ²	192.2 m ³

Figure B.15: 1492 Dayton Xenia Rd., Xenia, OH: 2nd Floor Architectural Floor Plan